

S5 Workshop Manual

Sub-volume of Circuit Overhaul Manual

Foreword







S5 Workshop Manual is to help technicians correctly understand and know well JAC automobiles, and possess the capacity of fast repair and reasonable maintenance. This manual comprises for fascicules for engine, chassis, vehicle body and electrical appliance and circuit maintenance respectively.

The Sub-volume of overhaul manual illustrates the complete vehicle schematic circuit diagram and wire harness diagram for S5 sedan in detail, and attaches the location instructions and diagrams for the electrical components and sensors of the complete vehicle so that the service personnel can rapidly find out the circuit faults of S5.

Any part of this manual can not be replicated or used in any form or by any means without written authorization or permission.

Rights reserved

Contents

Contents	ID	
How to use this manual	GI	
Circuit diagram	SD	
Connector shape	CC	
Wire harness layout	HL	
Component location	CL	

www.nasicoelec.ir

How to Use This Manual

Statement	GI-2
Notation	GI-7
Guide for Fault Checking	GI-14

www.nasicoelec.ir

www.nasicoelec.ir

Statement

This manual contains five major tools for circuit fault inspection and removal.

- Circuit diagram
- Component location index
- Component location diagram
- Guide wire connector shape
- wire harness layout

Circuit Diagram

Every system starts from its circuit diagram. The circuit diagrams illustrate all working paths for each component. Such as, power supply and ground wire for electrical load, guide wire connector location as well as fuse and switches constituting the circuits.

To diagnose and remove the faults, it shall firstly know the circuit diagram sufficiently.

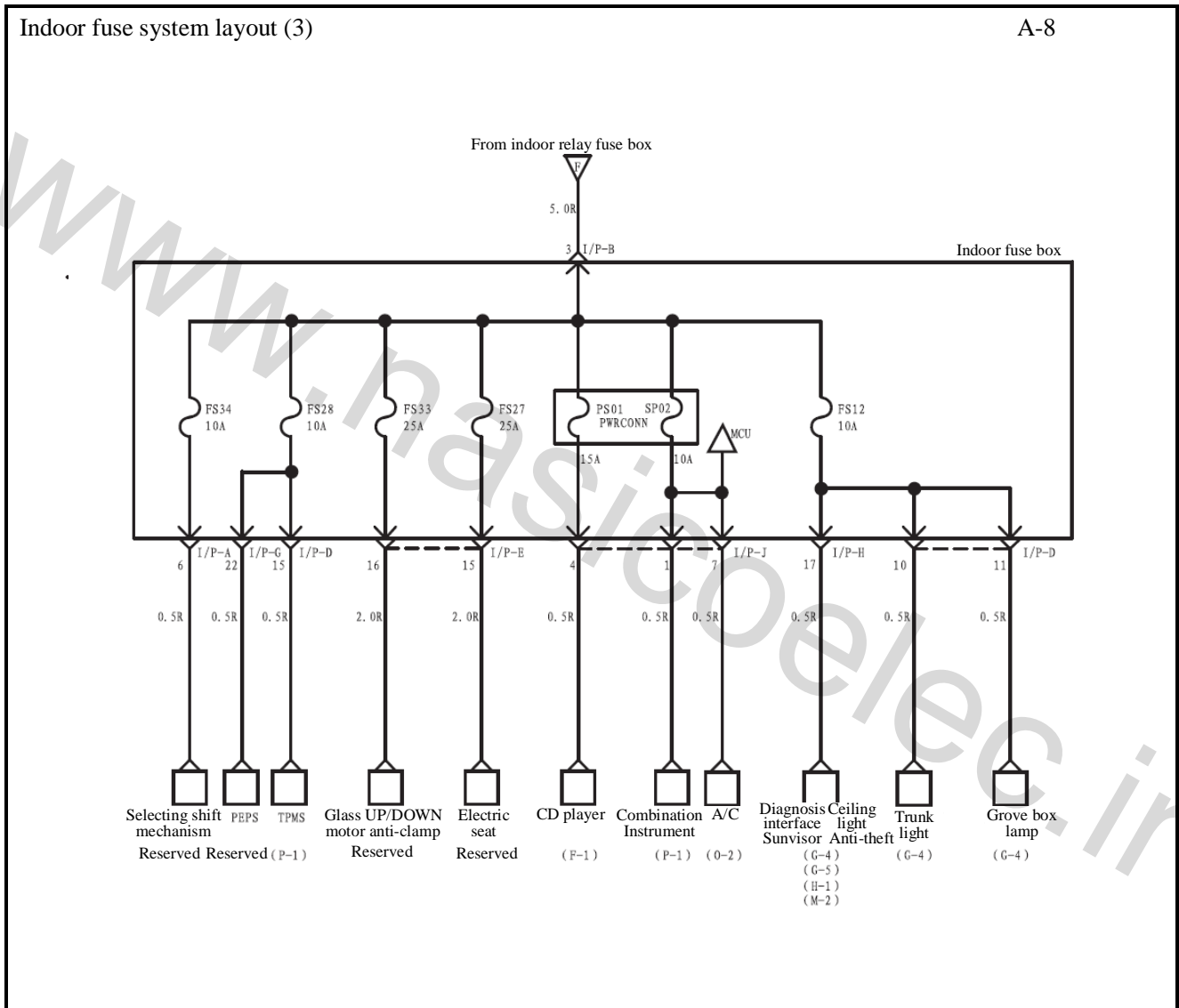

Component Location Index

Refer to the component location index in the back of every schematic diagram to locate the components in the vehicle. In the component location index, it lists the reference pages for major components, guide wire connectors, ground wire, diode as well as their specific locations.

It can find out the installation position diagram of nearly all components, guide wire connectors, ground wires, diodes in the component location diagram.

Component	Component Name	Refer to Page
E07	Three-way pressure switch	CL-13
M05	Headlamp adjusting switch	CL-25
R11	Rear defroster	CL-19
C04	Injector 1	CL-16
Connector		
ME01(White)		CL-25
ME02		CL-25
ME03		CL-25
CC01		CL-18
MF03		CL-25
ground wire		
G05		CL-17

Component Position Diagram

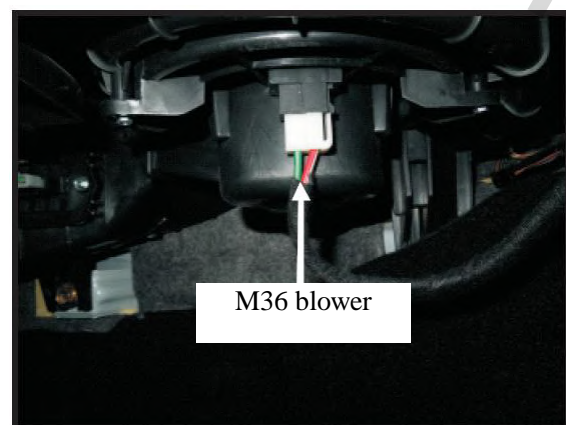
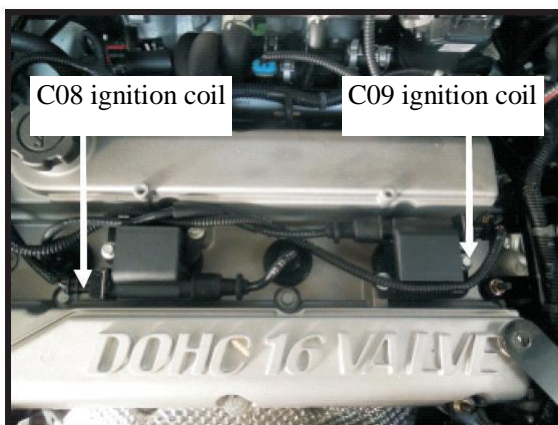

It is easy to find out the installation position of components and guide wire connectors illustrated in the component location index statement in the component location.



Guide Wire Connector Shape

This part shows the shape of every guide wire connector in circuit diagram and the specific location diagram of each piece of guide wire according to its color and terminal in the guide wire connector. Wire connector shape diagram will help you to find out the position needed inspection.

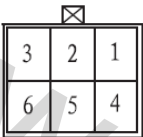
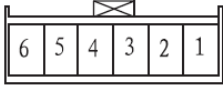
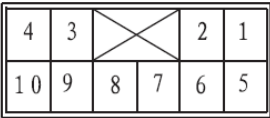
Interpretation of shape diagram: When the guide wire connectors are not separated, the direction is from wire harness of female guide wire to that of male guide wire; when separated, it is the component side or front plan of male guide wire connector. When the wiring of guide wire connector is for public use, it means this wire connector is the common wire connector.

<p>M28 A/C controller B</p> <p>- 6Female/Black</p>  <p>1. B Bonding 4. O 1 Gear wind speed 2. P 3 Gear wind speed 5. L 2 Gear wind speed 3. Y 0 Blower status 6. G 4 Gear wind speed</p>	<p>M26 ESC</p> <p>- 6 Female wire /light grey</p>  <p>1. --- --- 2. V ESC switch signal 3. RB r ON power 4. --- --- 5. B 0 Backlight- 6. Y 0 Backlight+</p>
<p>M29 Hazard warning switch</p> <p>- 10 Female/white</p>  <p>1. --- --- 6. --- --- 2. Y 0 Backlight+ 7. G Hazard warning light 3. B 0 Backlight- 8. B Bonding 号 4. --- --- 9. --- --- 5. --- --- 10. --- ---</p>	<p>M25 ESP-HDC switch</p> <p>- 6 Female /light grey</p>  <p>1. --- --- 2. V HDC switch signal 3. RB r ON power 4. --- --- 5. B 0 Backlight- 6. Y 0 Backlight+</p>

Guide Wire Connector Shape Diagram and Terminal Number Arrangement

1. Guide Wire Connector Shape Diagram

	Socket	Plug	Specification
Actual diagram			<p>The socket and plug are distinguished by terminal rather than the opening of sheath.</p> <p>Refer to the following table when connecting the connector number.</p> <p>Some connectors can not be numbered by this method. In that case refer to the section of “connector configuration”.</p>
Diagrams in this manual			

2. Terminal Number Sequence

	Number Sequence	Statement
Socket	<p>E1AA001D</p>	Numbering from up right to low left
Plug	<p>E1AA001D</p>	Numbering from up left to low right

Wire Harness Layout

Wire harness layout shows the installation position of major wire harness and guide wire connector, , as well as the path of major wre harness. The wre harness layout makes circuit maintenance easier and more convenient.

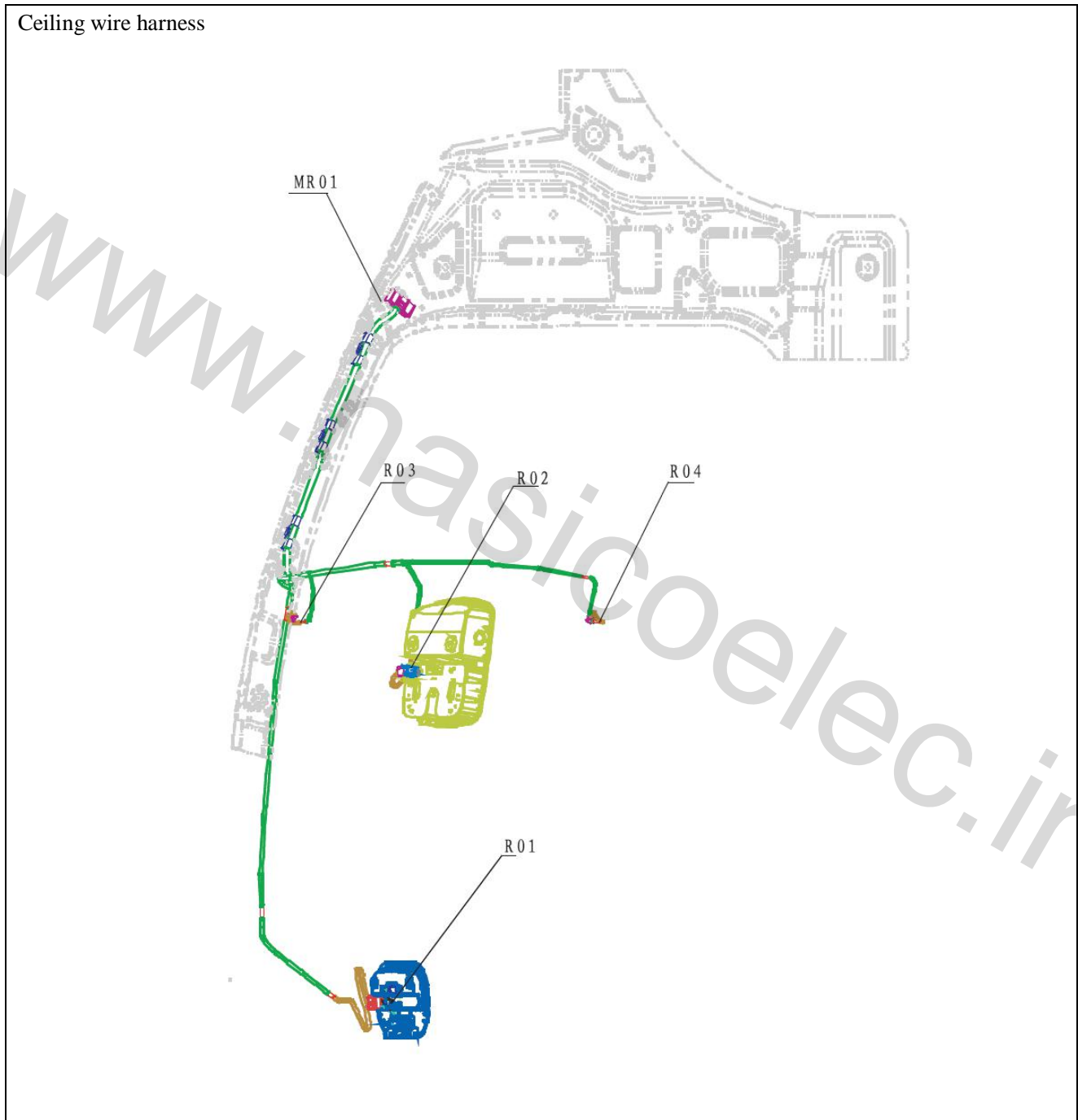



Notation

This manual uses the following electrical notations, electrical symbols and abbreviated names.

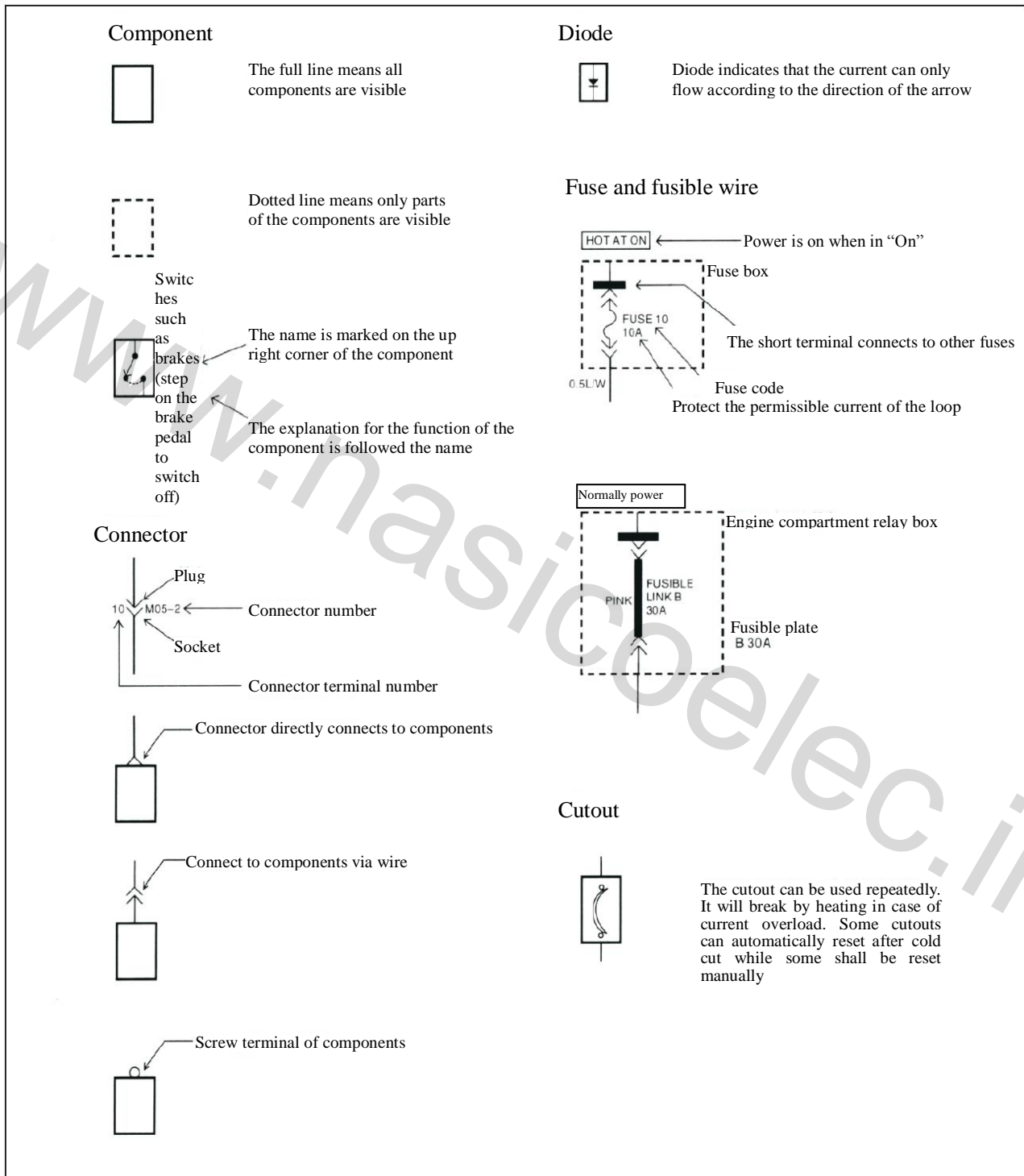
Notation in circuit diagram

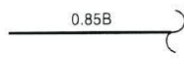

0.85B  The wave line means the circuit is disconnected, however it is connected actually

0.5Y/R  The guide wire is yellow with a red line on it

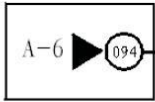
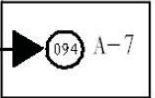
 A-6  A-7
The circuit is connecting in the two pages. The arrow shows the current direction. You can find "A" in the location with the symbol

0.5R  One piece of guide wire connects with an arrow directing another circuit

Name of circuit

The disconnected wire shows part of the circuits. Refer to the circuits listed in the component diagram

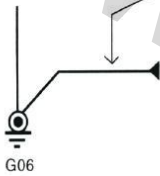
 G06
Refer to ground wire layout in Page SD-23

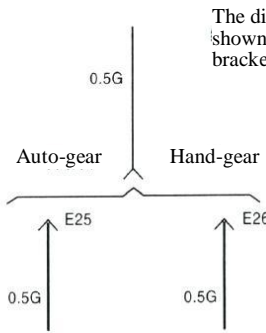
0.5G  The different choice of circuit is shown by the diagram selection bracket

Auto-gear Hand-gear
E25 E26
0.5G 0.5G

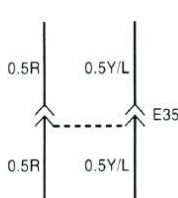
0.5R 0.5Y/L  E35
0.5R 0.5Y/L
The dotted line indicates both the red line and the yellow-blue line are in E35 connector

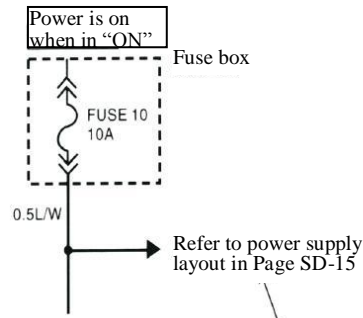
Power is on when in "ON"
Fuse box
FUSE 10 10A
0.5L/W  Refer to power supply layout in Page SD-15

The branch circuit only shows the connection point. Refer to the identified circuits for detailed contents of the additional wires

Connection point

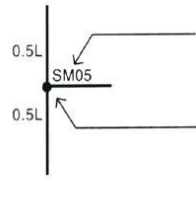
0.5L  SM05
0.5L
Connection point number
The connection point is shown by round dot, and the accurate positions are various on different vehicle models

Grounding "G"

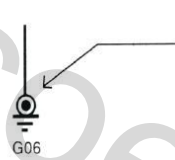
 G06
This symbol shows the tail terminal of the guide wire connects to body metal.

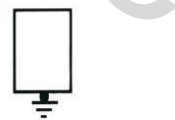
This symbol for bonding (one dot three lines) shows the component enclosure connects to the body metal

Shielded wire

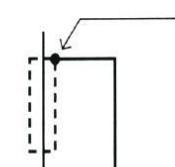

It is wrapped the guide wire with shield layer to prevent from radio interference. The shield layer is always grounded

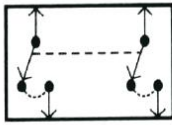
S witch

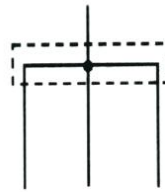

These switches move together. The dotted line shows they are connected by mechanical devices

Connector



Show multiple power lines are connected

Relay

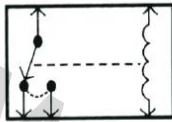

The relay shows the status of the coil without current. Once current passes the contactor, it will switch.

Normally open contact
Normally-closed contact

I ndicator

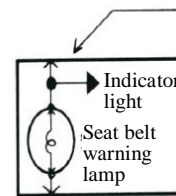











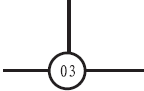
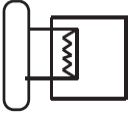

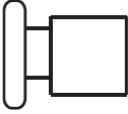







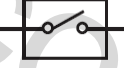

The seat belt indicator light connects with other indicator light light inside the combination instrument

The indicator light is shown by the lighted icon.

www.nasicoelec.ir

Electrical Symbols on the Circuit Diagram

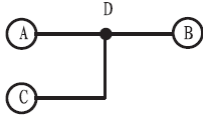
Electrical Symbols	Symbol Description		Symbol Description
 Battery	<ul style="list-style-type: none"> ● Generate current by chemical action ● Directly supplement current to the circuit 	 Electric heating	<ul style="list-style-type: none"> ● Generate heat by current
 Ground wire point of wire harness	<ul style="list-style-type: none"> ● Connect to the ground wire point of the vehicle body by wire harness so that the current will connect to battery negative terminal and form loop 	 Cigarette lighter	<ul style="list-style-type: none"> ● The heat generated by current can be used for on-board power supply as well
 Slow-blow	<ul style="list-style-type: none"> ● If it exceeds the rated current, the fusible wire will be fused and the current will be cut off immediately ● Warning: it can not exceed the rated current when replacing the fuse 	 On-board power supply	<ul style="list-style-type: none"> ● It can distribute power to external electric appliances with rated voltage
 Plate type fuse	  Slow-blow Plate type fuse	 Horn	<ul style="list-style-type: none"> ● The horn sounds when passing the current
 Lighting	<ul style="list-style-type: none"> ● Current passes the filament to generate light and radiate 	 Speaker	
 Resistance	<ul style="list-style-type: none"> ● It is mainly used in series circuit to protect the electric components with nominal voltage 	 Switch	<ul style="list-style-type: none"> ● Permit or prevent the current passing by opening or closing the loop
 Motor	<ul style="list-style-type: none"> ● Convert into mechanical energy by electric energy 	 Diode	<ul style="list-style-type: none"> ● Diode: It permits the current to pass the diode along one direction
 Pump	<ul style="list-style-type: none"> ● Absorb or discharge gas or fluid by motor 	 Luminescence diode	<ul style="list-style-type: none"> ● Lighten when current passing ● The diode is different with common bulb that it does not generate heat when lightening

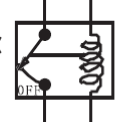
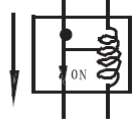
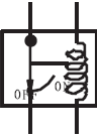
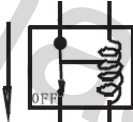
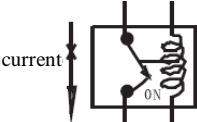
Electrical Symbols	Symbol Description	Electrical Symbols	Symbol Description
<p>Sensor</p>  <p>(Thermistor)</p>	<ul style="list-style-type: none"> The resistance value changes with temperature 	 <p>Fan</p>	<ul style="list-style-type: none"> It is used for heat dissipation of the engine
<p>Sensor</p>  <p>(Sliding resistor)</p>	<ul style="list-style-type: none"> The resistance value changes with the component location 	 <p>Loop intra-connection</p>	 <ul style="list-style-type: none"> The above diagram shows Loop C-D intra-connects with Loop A-B.
 <p>Normally open relay</p>	<ul style="list-style-type: none"> Generate magnetic force via coil to actuate relay contact and make the current pass. <div style="display: flex; justify-content: space-around;"> <div style="text-align: center;"> <p>For coil without current</p>  <p>Without current</p> </div> <div style="text-align: center;"> <p>For coil with current passing through</p>  <p>With current</p> </div> </div>		
 <p>Nominal-closed relay</p>	<ul style="list-style-type: none"> Generate magnetic force via coil to actuate relay contact and make the current pass. <div style="display: flex; justify-content: space-around;"> <div style="text-align: center;"> <p>For coil without current</p>  <p>With current</p> </div> <div style="text-align: center;"> <p>For coil with current passing through</p>  <p>Without current</p> </div> </div>		

Guide Wire Color Description

Wire Color	Code	Wire Color	Code
Black	B	Orange	O
Blue	L	Pink	P
Brown	Br	Red	R
Green	G	Purple	V
Gray	Gr	Yellow	Y
Light Green	Lg	White	W

Wire harness identification mark and system function paging code

Divide the guide wire into the following types according to different positions of the guide wire

The complete vehicle circuit is distinguished by the following paging code according to system

Wire Harness Name	Connector Code
Main wire harness, A/C wire harness	M
ABS module wire harness	A
Engine compartment wire, power wire harness	E
Control wire harness	C
Frame wire harness	F
Left/ right front door wire harness	D
Left /right back door wire harness	D
Tailgate wire harness	R
Ceiling wire harness	R
Radar sensor wire harness	R
Rear defrost wire	R
Power wire harness	B

System Function	Paging Code
Power distribution system	A
Start system	B
Charging system	C
Engine ECM system	D
Reversing radar	E
ACC system	F
Lighting	G
ACC system	H
Electric rearview mirror	I
Sunroof system	J
Combination switch	K
Airbag	L
Diagnosis system	M
ESC ABS brake system	N
A/C System	O
Instrument system	P
Door & window system	Q
Door lock system	S
Ground wire layout	T
Electrical power steering	U

Guide Wire Connector Identification Code

The guide wire connector identification code comprises of wire harness position identification code and guide wire connector identification code. Refer to wire harness layout for the guide wire connector positions

For instance:

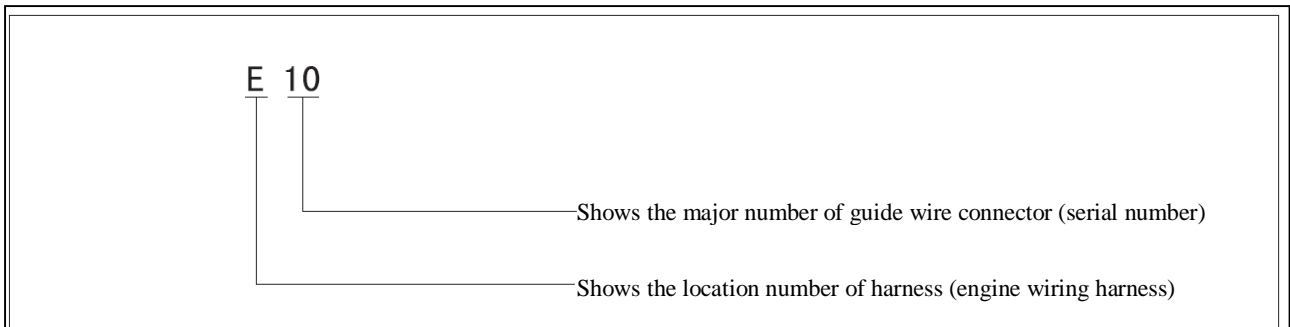

Notice

The guide wire connector between wire harnesses is shown by the following code

For instance:

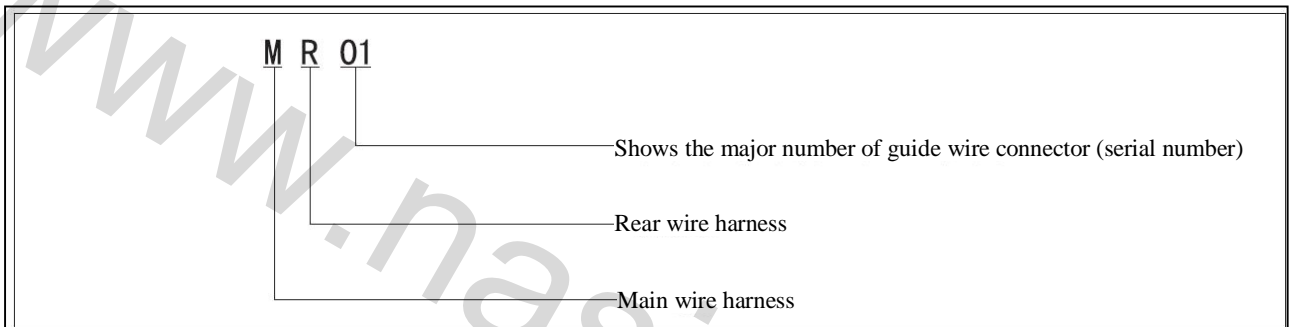

Relay identification

Relay identification code comprises of abbreviation of relay and major number (serial number)

For instance:

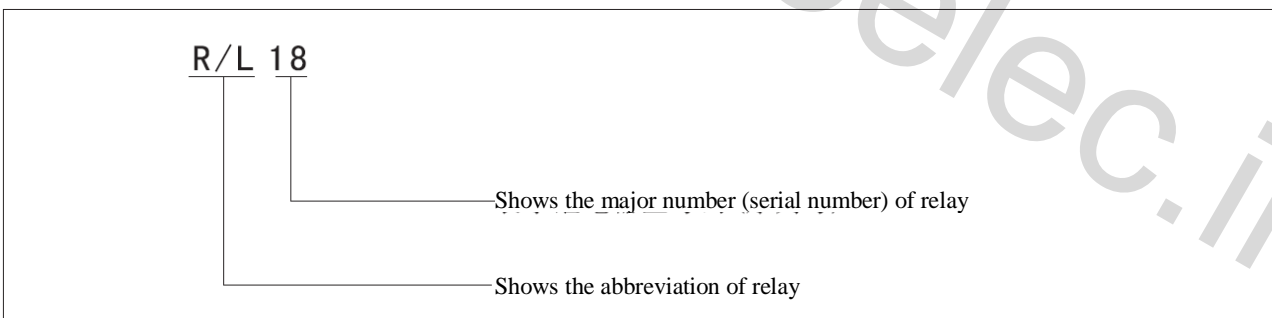

Fault checking guide

Fault checking procedures

Check according to the following 5 steps

1. Verify the dissatisfaction of the user

It shall check the faulty circuit components complained by the user and make record for the correct repair and maintenance. It is forbidden to dismantle the vehicle before

2. Circuit diagram interpretation and analysis

Analyze and judge the whole circuit of the faulty component from power supply to ground wire according to the system circuit diagram, and confirm the operating method. If fails to judge the operating method, refer to the circuit working reference. And inspect other public circuits of the faulty circuit. Such as the public system circuits of fuse, ground wire and cutout on the circuit diagram. Inspect the public circuits failed to be checked in the first step. If the public circuits work normally, the problem lies in the circuit itself. If several circuits are problematic in the same time, it may be the problem of fuse or ground wire.

3. Circuit and component inspection

Inspect it for the second step by testers. Effective fault diagnosis shall be logical and simple operating process. It shall confirm the fault causes by fault diagnosis procedures or table. Start from the most possible reason and easiest checking component.

4. Fault maintenance

Repair necessarily in case of any fault.

5. Confirm circuit operation

After finished repairing, it shall recheck to confirm the fault has been removed. In case of fuse burnout, it shall inspect all circuits publicly using this fusible wire

Fault diagnosis devices

Voltmeter and test lamp

It can use test light or voltmeter to check circuit status and use test light to check whether there is voltage or not. The test light is composed of a pair of guide wire and 12V bulb. In inspection, one piece of guide wire connects to the ground wire while the other connects to certain measuring point. If the light turns on, this point is supplied with power.

Notice

When checking the voltage of electronic control module, such as the engine control module (ECM) of the electronic fuel injection engine, it shall (necessarily) use digital voltmeter with 10M or higher resistance to check. Checking the module circuit by test light may be damage the internal circuit. Therefore, never use test light to check the electrical circuits.

The application methods of voltmeter and test light are basically the same. The difference lies in the test light can only check whether there is voltage while the voltmeter can display the value of voltage.

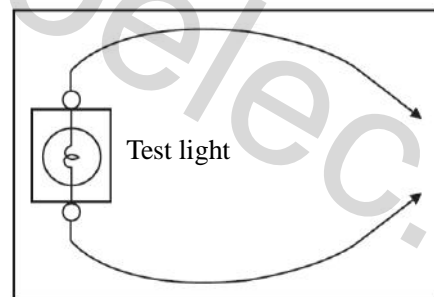

Test light and resistance meter with self contained power

Check whether the circuit is accessible by the test light and resistance meter with self contained power. The test light with self contained power supply is composed of bulb, battery and two pieces of guide wire. The bulb turns on if the two pieces of guide wire connect. Before inspection, it shall dismantle battery negative guide wire and pull out the fuse of this circuit.

Notice

Checking the module circuit by test light with self contained power supply may be damage the internal circuit. Therefore never test the electrical circuits by test light with self contained power supply

The application methods of resistance meter and the test light with self contained power supply are basically the same, but the resistance meter can display the value of resistance. The low resistance shows the favorable accessibility.

The semiconductor elements must be inspected by digital multi-meter with 10M or higher resistance. When measuring the resistance by digital multi-meter, it shall cut off the battery negative guide wire; otherwise it will get fault resistance value. When measuring the resistance by the resistance meter, the diode or semiconductor components in the circuit may affect the value. To check whether the component affect the measuring value, it shall measure one value and measure another after replacing the polarity. If the two values are different, the semiconductor components impact the measuring value.

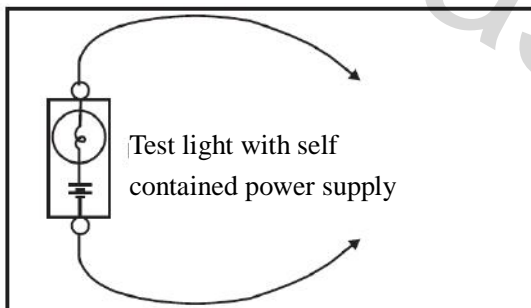

Jumper wire with fuse wire

Use the jumper wire to check open loop circuit.

The jumper wire is the test tool using in series with the tested guide wire

The jumper wire can use together with most of the guide wire connectors without damaging them.

Warnings

To protect the tested circuit, it can not use jumper with fuse wire larger than the rated capacity. Neither can it use jumper wire instead of input or output signal when connecting to the control modules such as ECM and TCM.

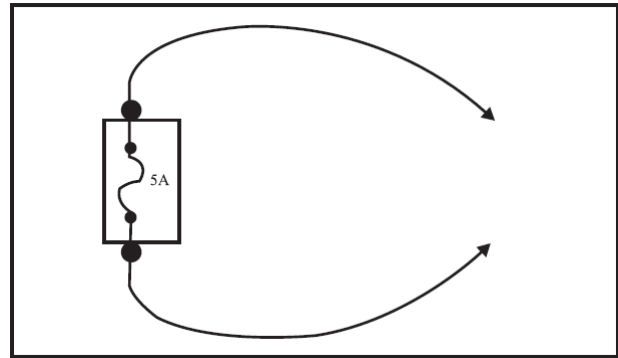

Short circuit tester

Short circuit tester can find out the position of short circuit. It will generate impulsive magnetic force when using the short circuit tester to check the short circuit circuit so as to find out the short position.

Fault checking

1. Voltage inspection

It is to check whether there is voltage in certain point. When checking certain terminal of the guide wire connector, it can partly dismantle guide wire connection and test from the back of the guide wire connector.

- ① Connect the negative terminal of the meter with the battery negative terminal when checking the voltage by test light or voltmeter.
- ② Connect the other wire of the test light or voltmeter to the position to be tested.
- ③ If the test light turns on, it is powered on. For checking by voltmeter, if the value displayed on the voltmeter is above 1V less than the rated value, the circuit is faulted.

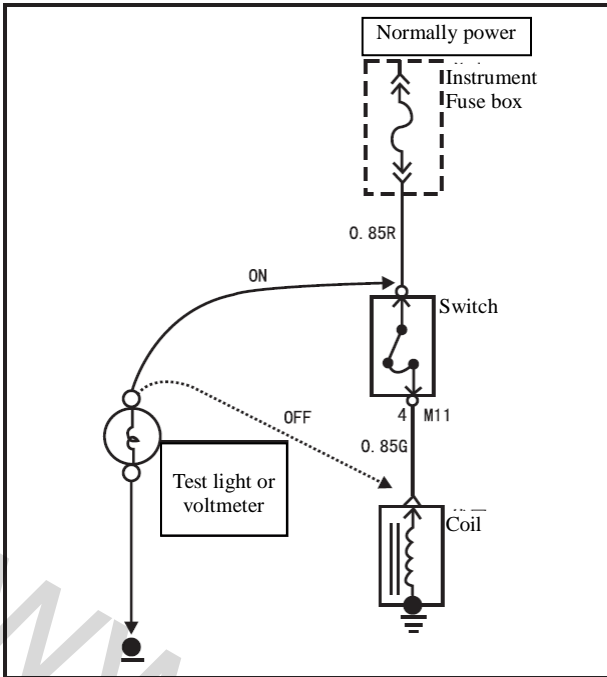

2. Power-on test

- ① Dismantle the negative terminal of the battery
- ② Connect one lead of the test light or resistant meter with self contained power supply to the position to be tested. When using the resistance meter, it shall short circuit the two pieces of lead and zero the meter by zero setter.
- ③ Connect the other lead of the meter to the other terminal of the load to be tested.
- ④ The light with self contained power turns on, the circuit is accessible; When using the resistance meter, when the resistance value is very small and approaches to 0, it means the accessibility is favorable.

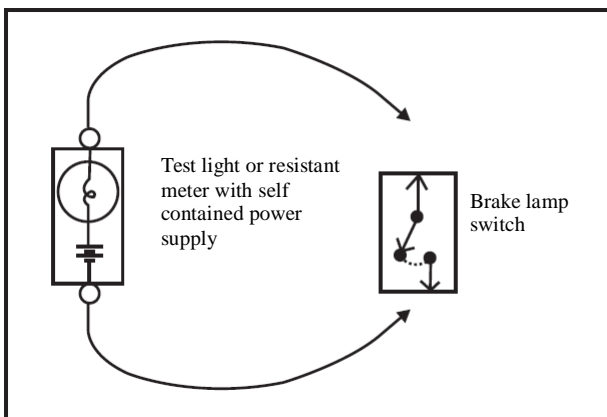

3. Short circuit test

- ① Dismantle the negative terminal of the battery
- ② Connect one lead of the test light or resistant meter with self contained power supply to one terminal of the fuse.
- ③ Connect the other lead of the test light or resistant meter with self contained power supply to the ground wire .
- ④ Look over the wire harness from the one approaching the fuse box. Repeat this process till it is approximately 15cm from the test light or resistant meter with self contained power supply.
- ⑤ When the test light turns on or resistance displays, the circuit from this part to the ground wire is short circuit.

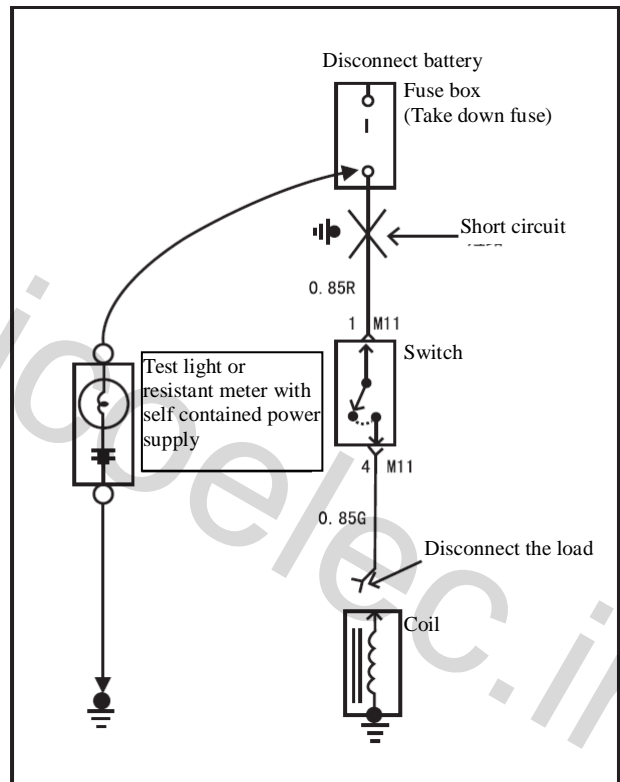

4. Check the short circuit by short-circuit detector

- ① Pull out the fused fuse wire, and dismantle the battery negative terminal.
- ② Connect the short-circuit detector to the terminal of fuse wire.
- ③ Switch on to check the circuit.
- ④ When the short-circuit detector moves to the short circuit position, it will generate impulsive magnetic force between the fuse wire and the short circuit position.
- ⑤ Move short-circuit detector from the fuse box along the guide wire gradually. As long as the short-circuit detector is between the fuse wire and short circuit, the pointer will move with the size of the pulse current. Once the detector passed the position of short circuit, the pointer will stop.

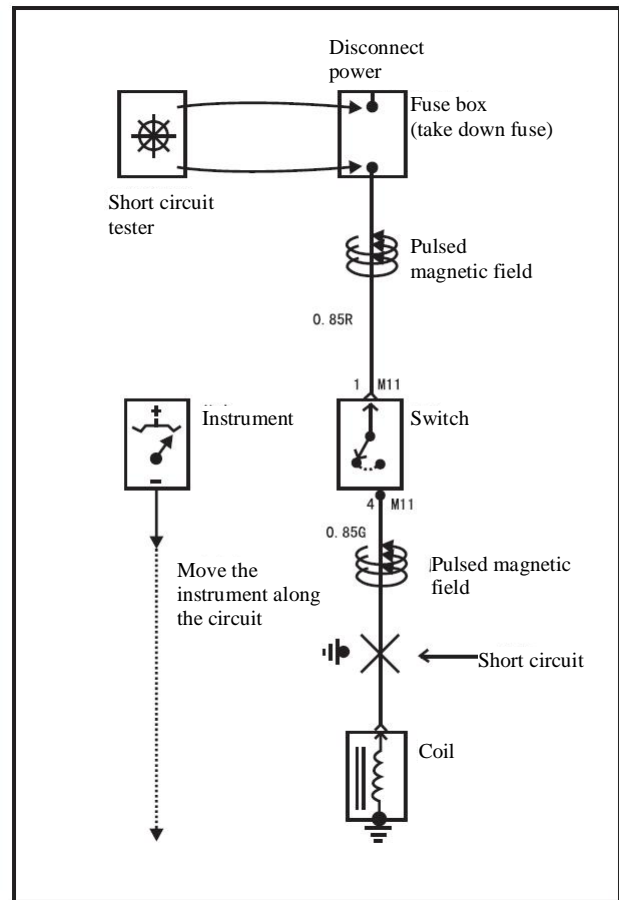

www.nasicoelec.ir

Catalogue of Circuit Diagram

Power Layout System	SD-3
Indoor Fuse Box Power Layout	SD-3
Indoor Fuse Box Power Layout	SD-8
Indoor Fuse Box and Assistant-terminal Box layout	SD-14
Indoor Fuse Box Layout	SD-17
Start System	SD-18
Charging System	SD-19
Electric Control System	SD-20
Reversing Radar System	SD-25
Audio System	SD-26
Lighting System	SD-27
Small light	SD-27
Rear Fog Lamp	SD-28
Turning light and Hazard Warning Lamp	SD-29
Sunvisor, Grove box, Trunk, Ceiling Light	SD-30
Door Lamp	SD-31
Headlamp	SD-32
Front Fog Lamp	SD-33
Front Window Deicing Rearview Mirror Defogging	SD-34
Cigarette Lighter, On-board Power-supply System	SD-35

Electric Horn	SD-36
Body Control Module (BCM) system	SD-37
Electric Outer Rearview Mirror	SD-39
Sunroof System	SD-40
Rear Wiper System	SD-41
Front Wiper Washing	SD-42
Airbag System	SD-43
Diagnosis Connection Layout	SD-44
Brake System	SD-46
Brake Lamp , Hand Brake Lamp, Fluid Level Light	SD-46
ESC (ABS)	SD-47
A/C System	SD-48
Indicator Light and Instrument	SD-51
Electric Door/Window System	SD-52
Door Lock System	SD-53
Electric Door Lock	SD-54
Remote Control and Anti-Theft Alarm	SD-55
Tailgate locks	SD-56
Electric Steering Pump Control (EPS)	SD-57
Ground wire layout	SD-58

A-1

Power system layout (1)

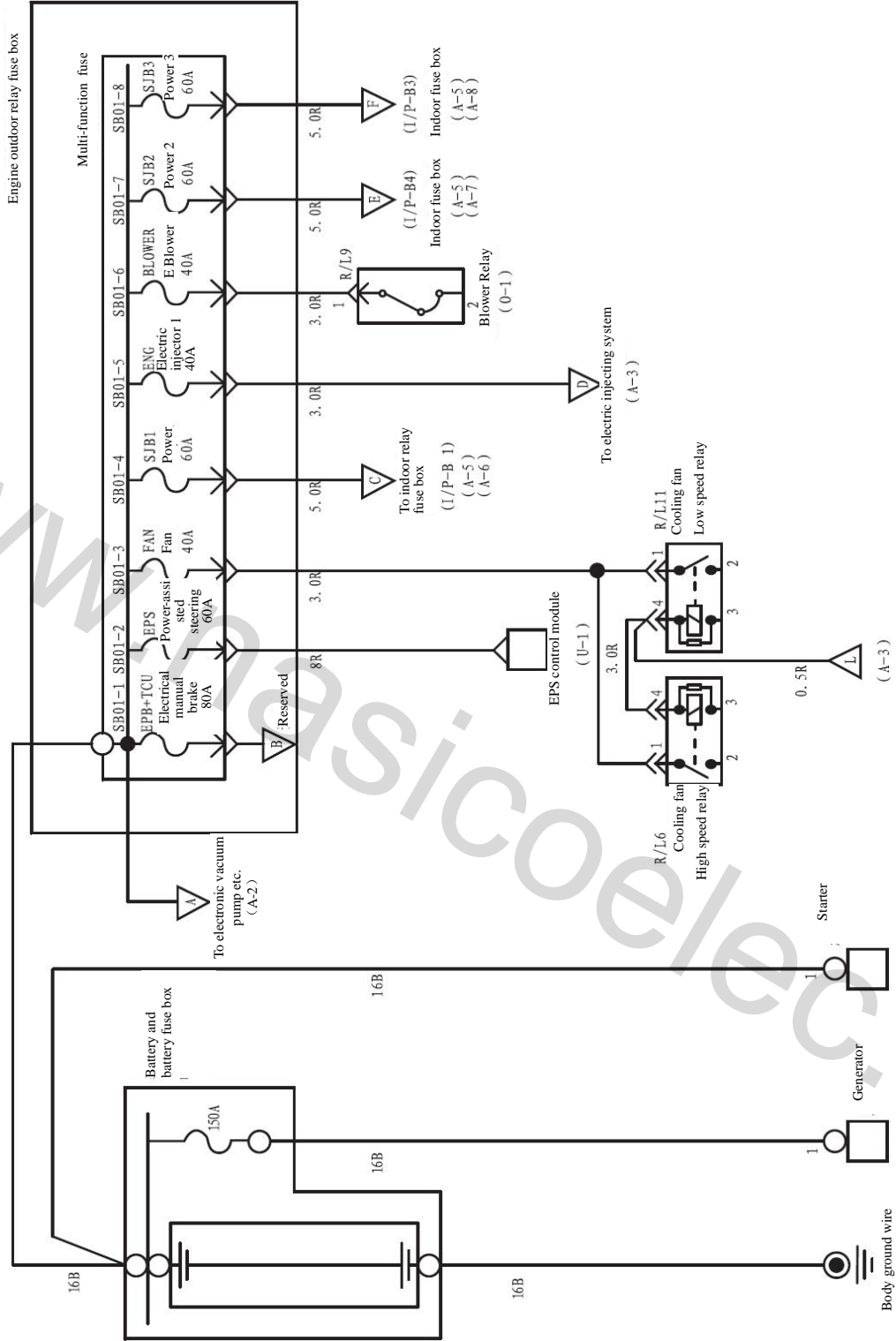

www.asicoc.com

A-2

Power system layout (2)

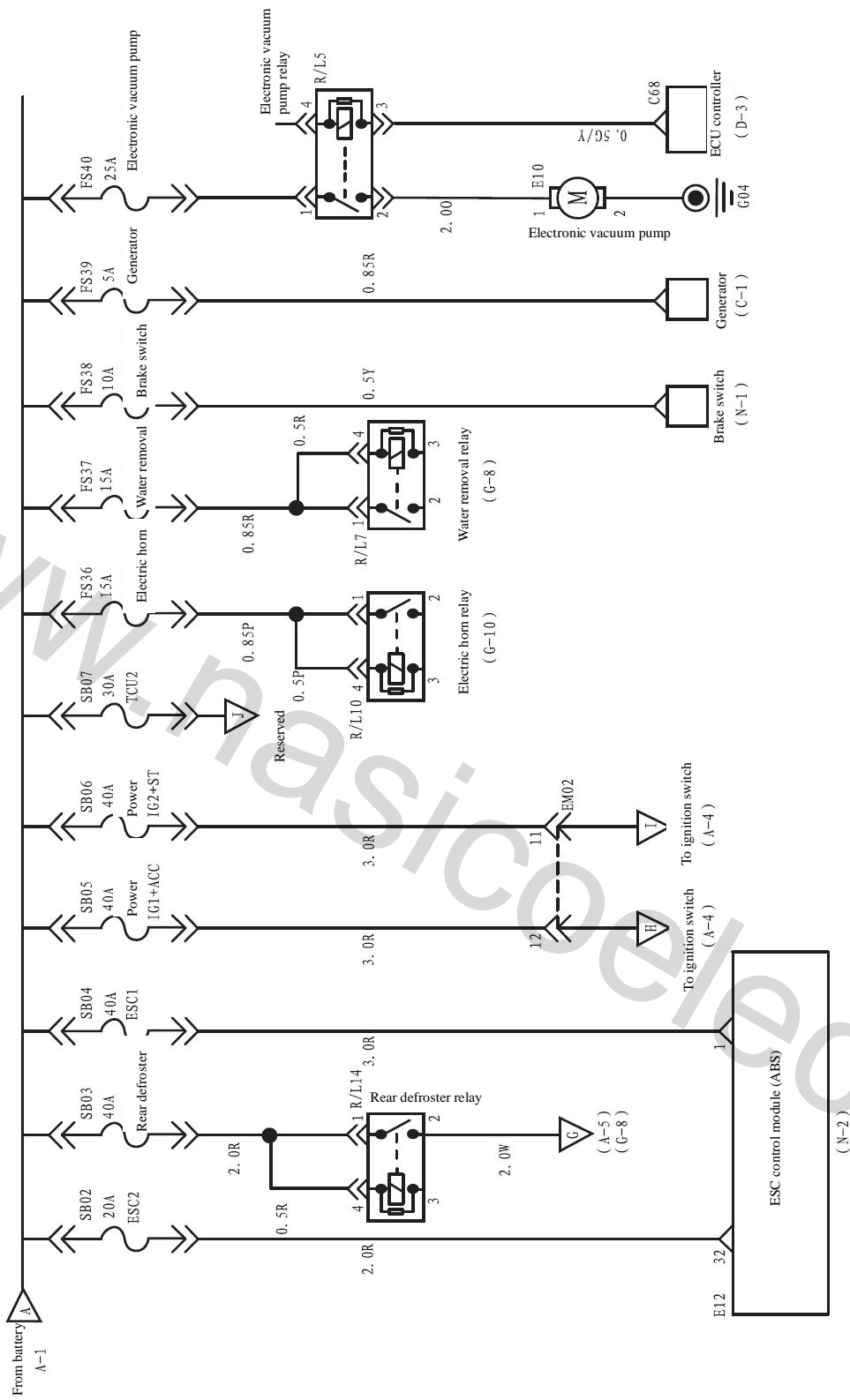

A-3

Power systematic layout (3)

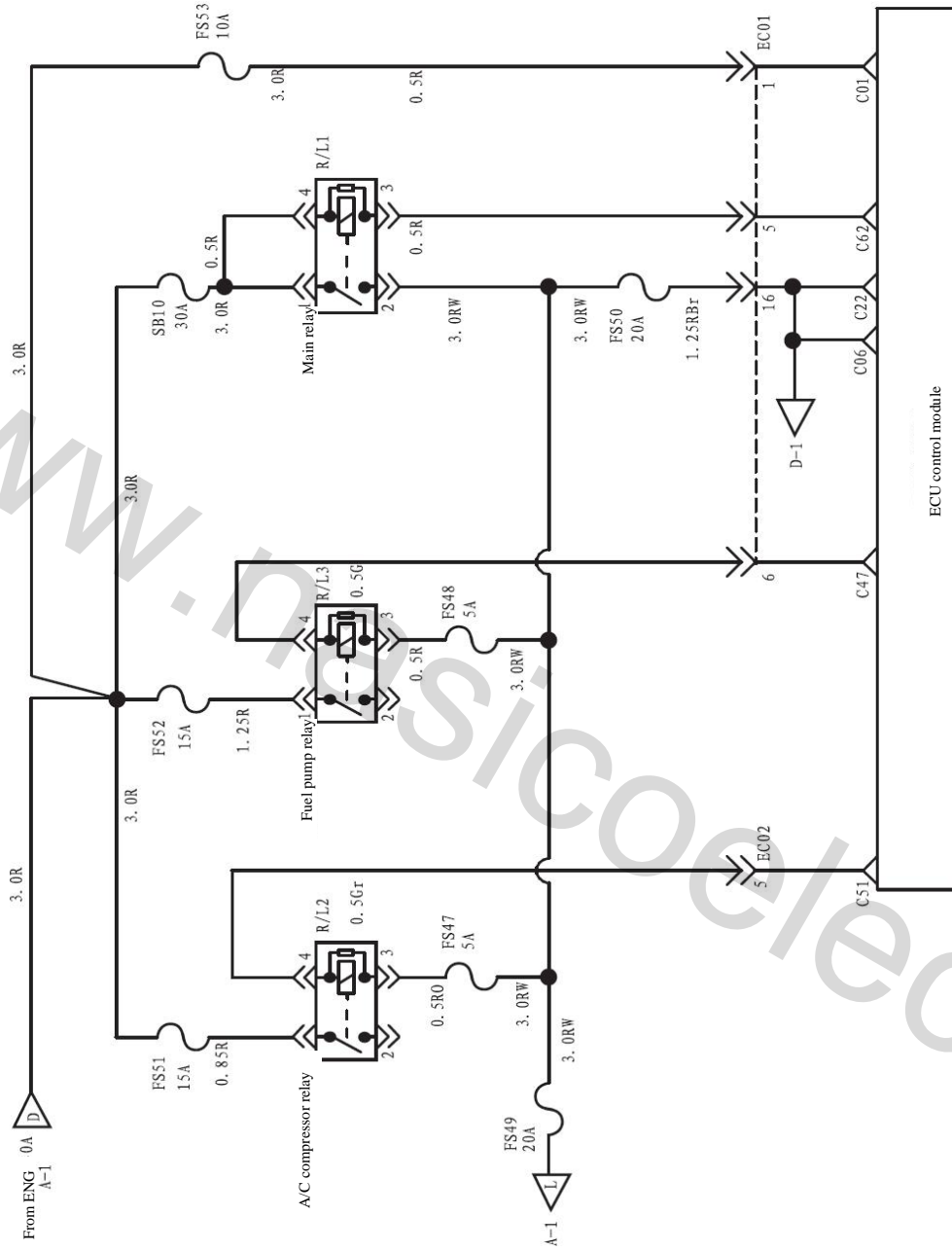

www.S5SicoElec.ir

Power systematic layout (4)

A-4

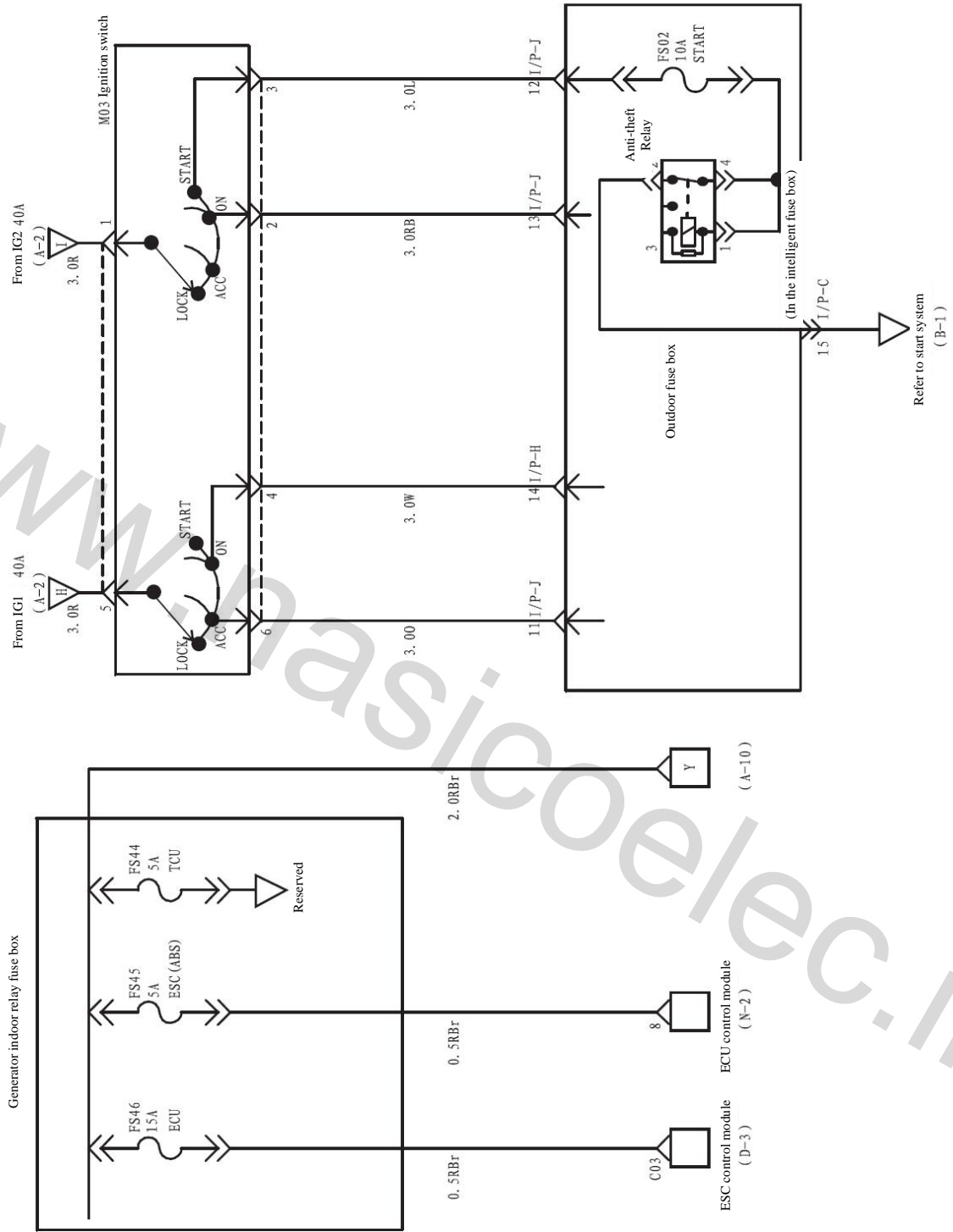

A-5

Power Systematic Layout (5)

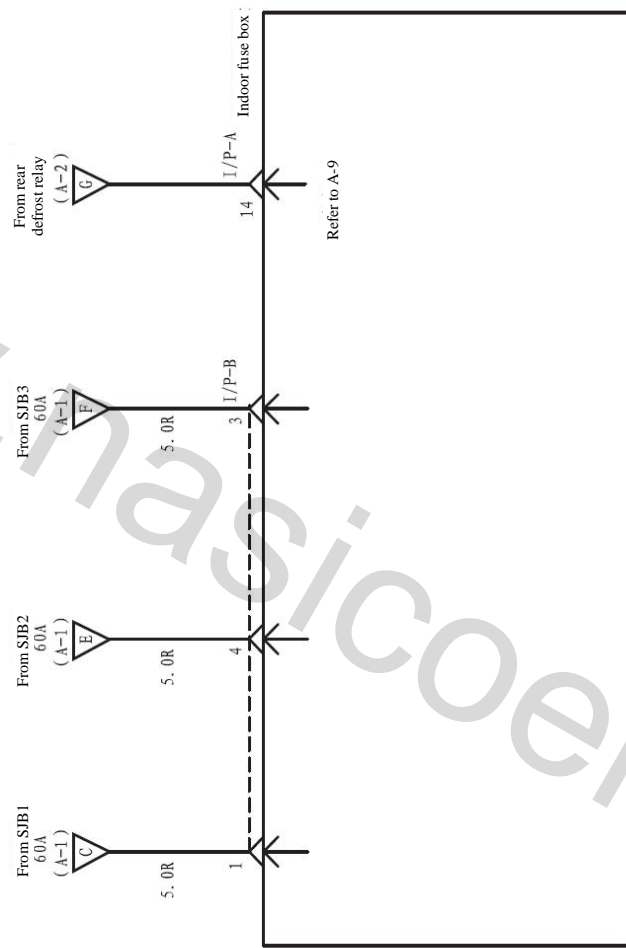

www.mahsicoelec.ir

A-6

Indoor fuse system layout (1)

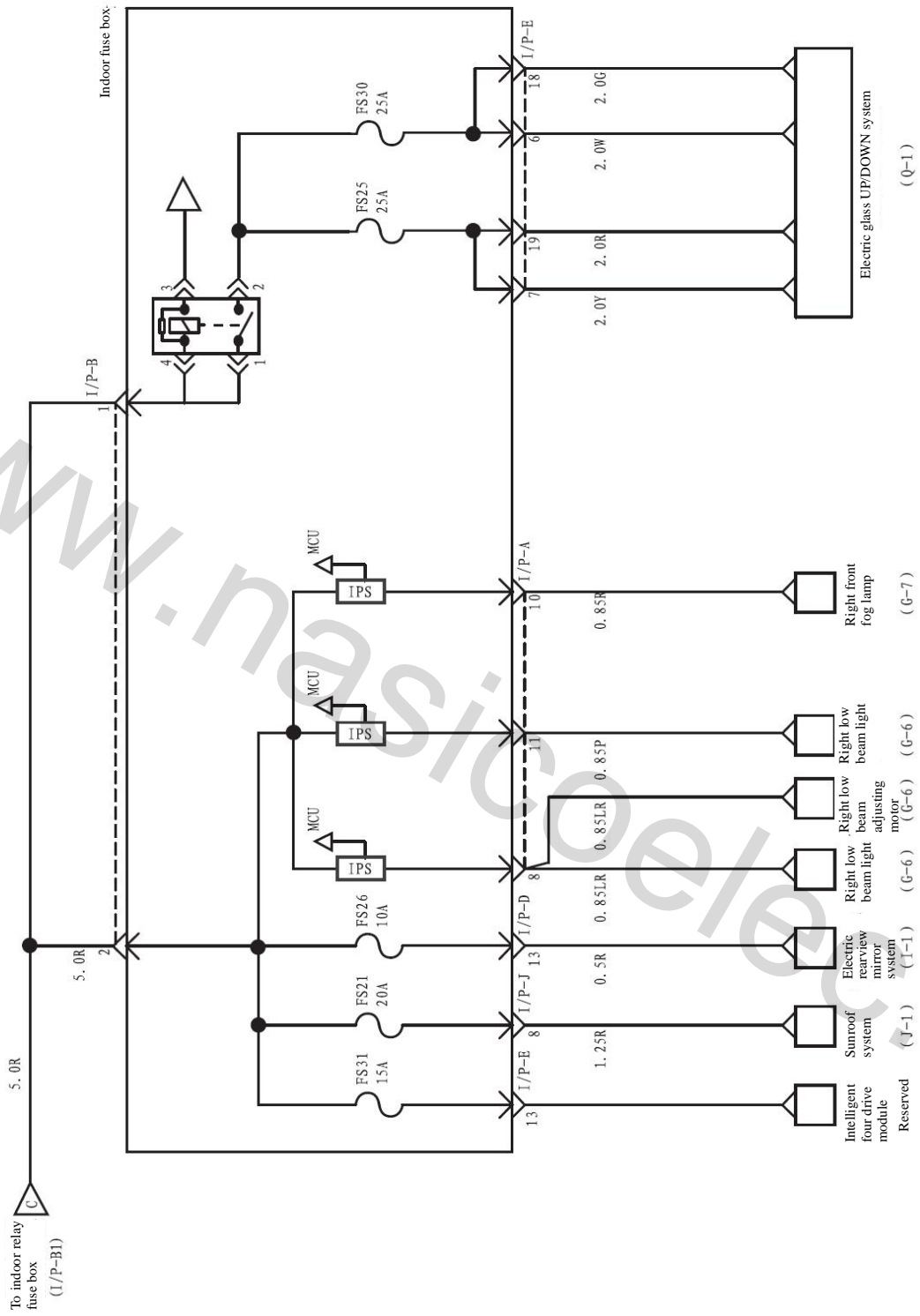

Indoor fuse system layout (2)

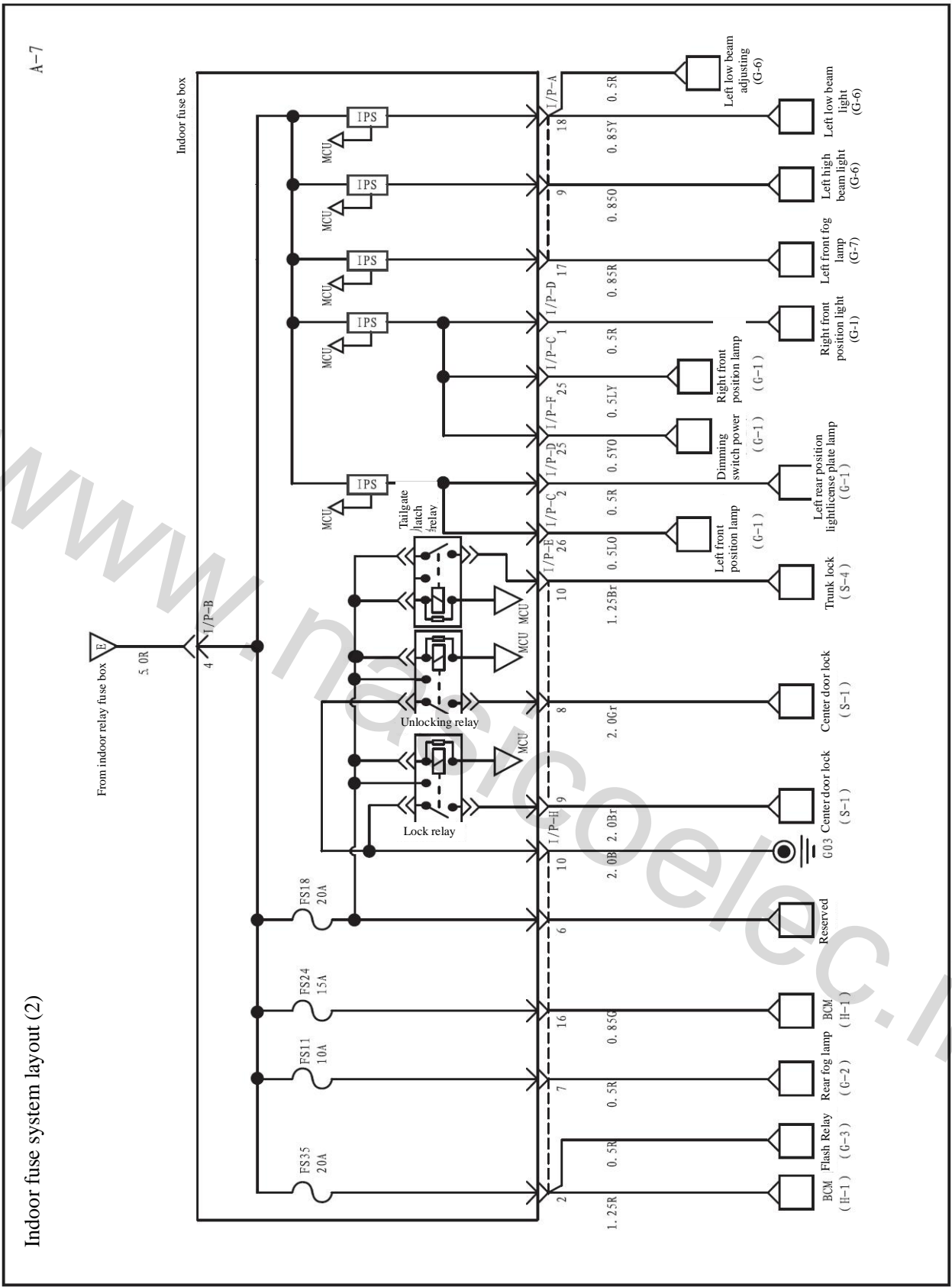

Indoor fuse system layout (3)

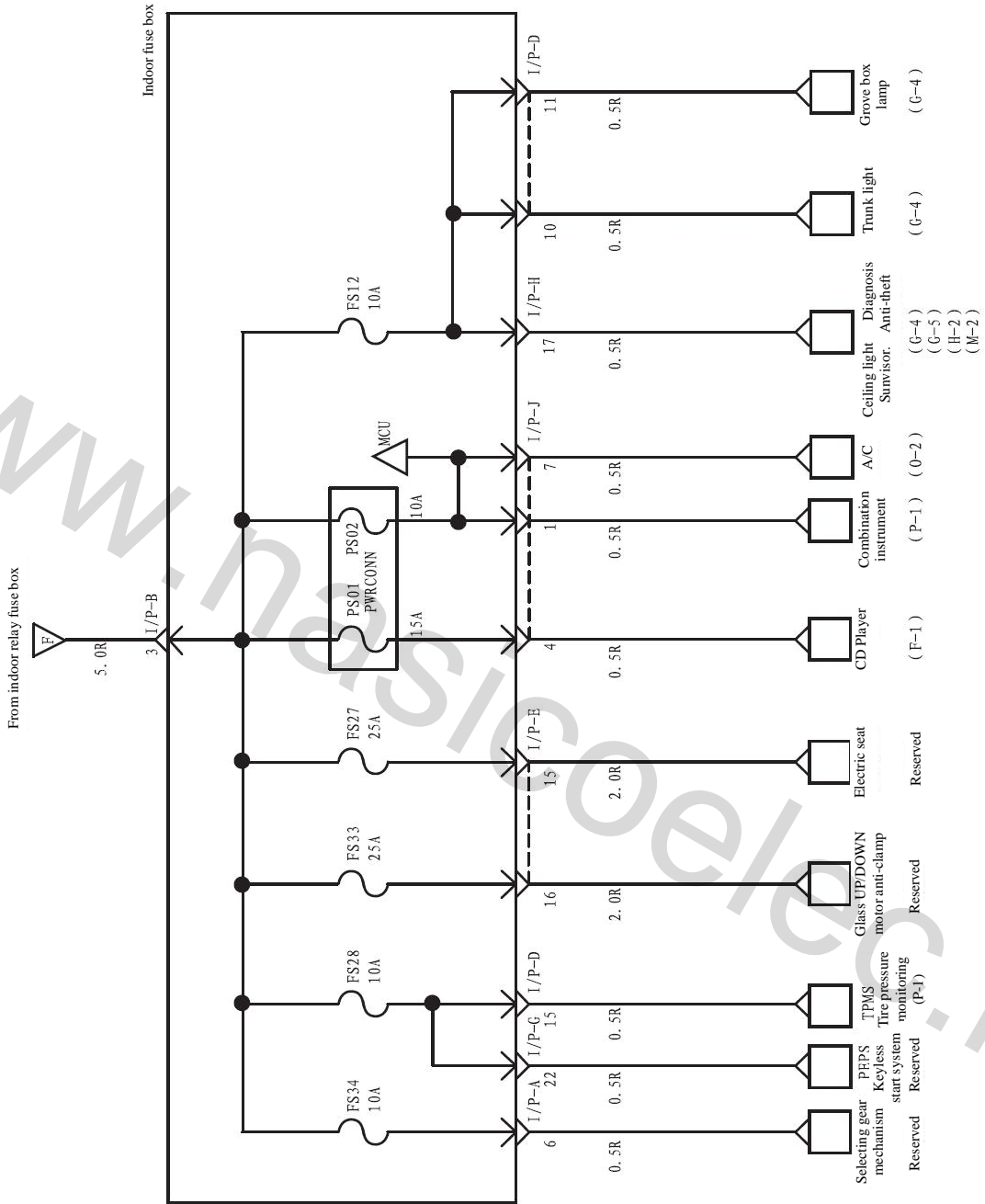

A-9

Indoor fuse system layout (4)

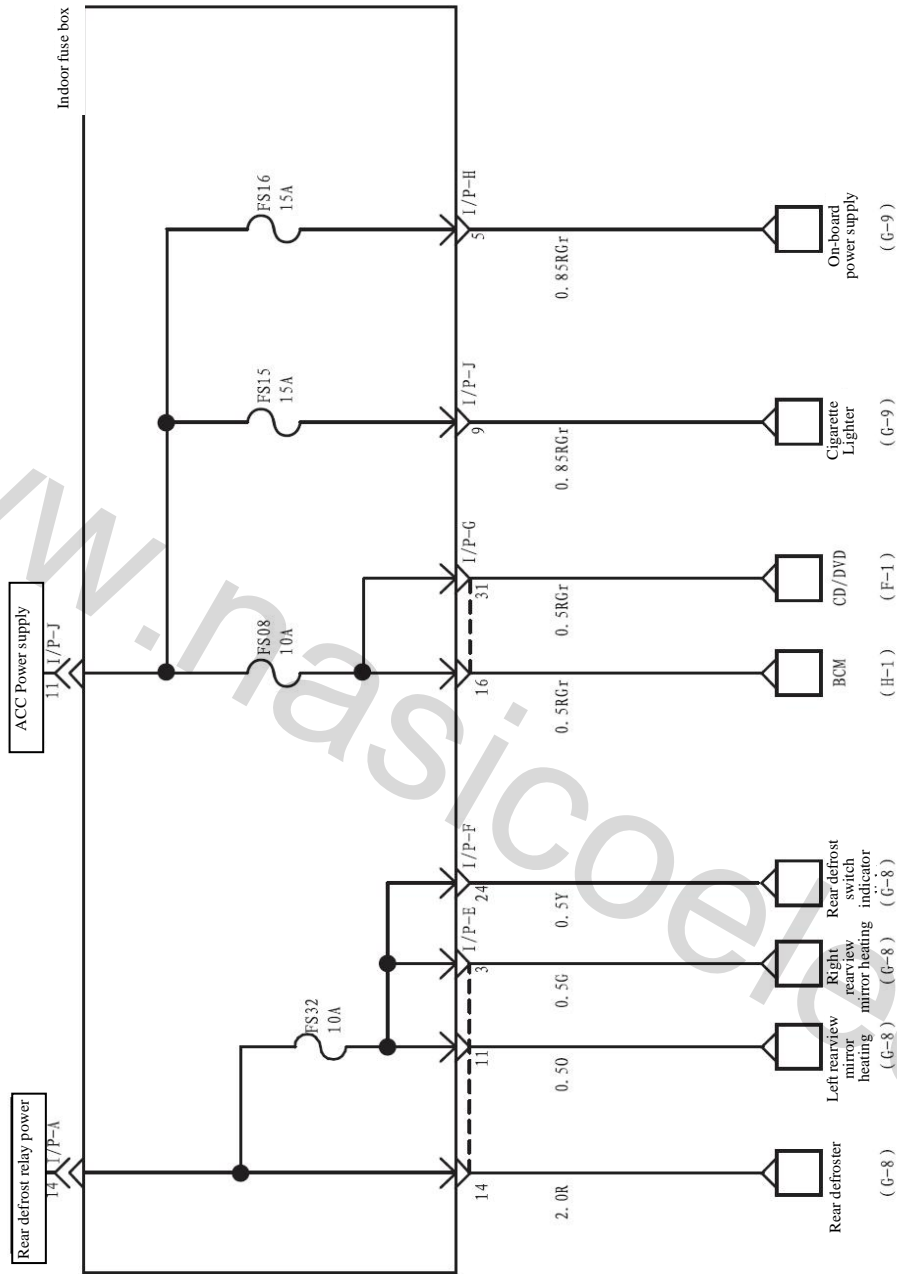

A-10

Indoor fuse system layout (5)

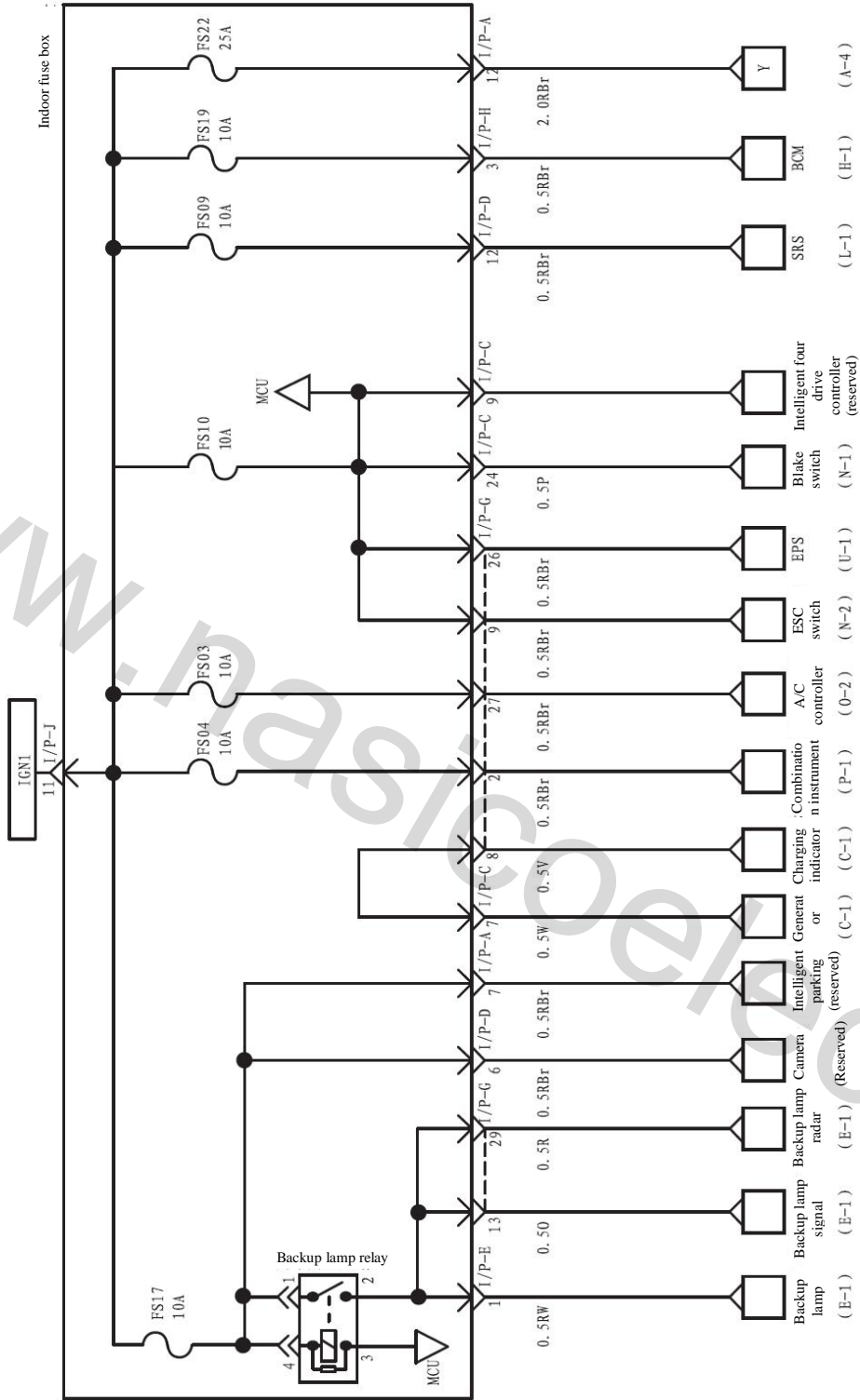

A-11

Indoor fuse system layout (6)

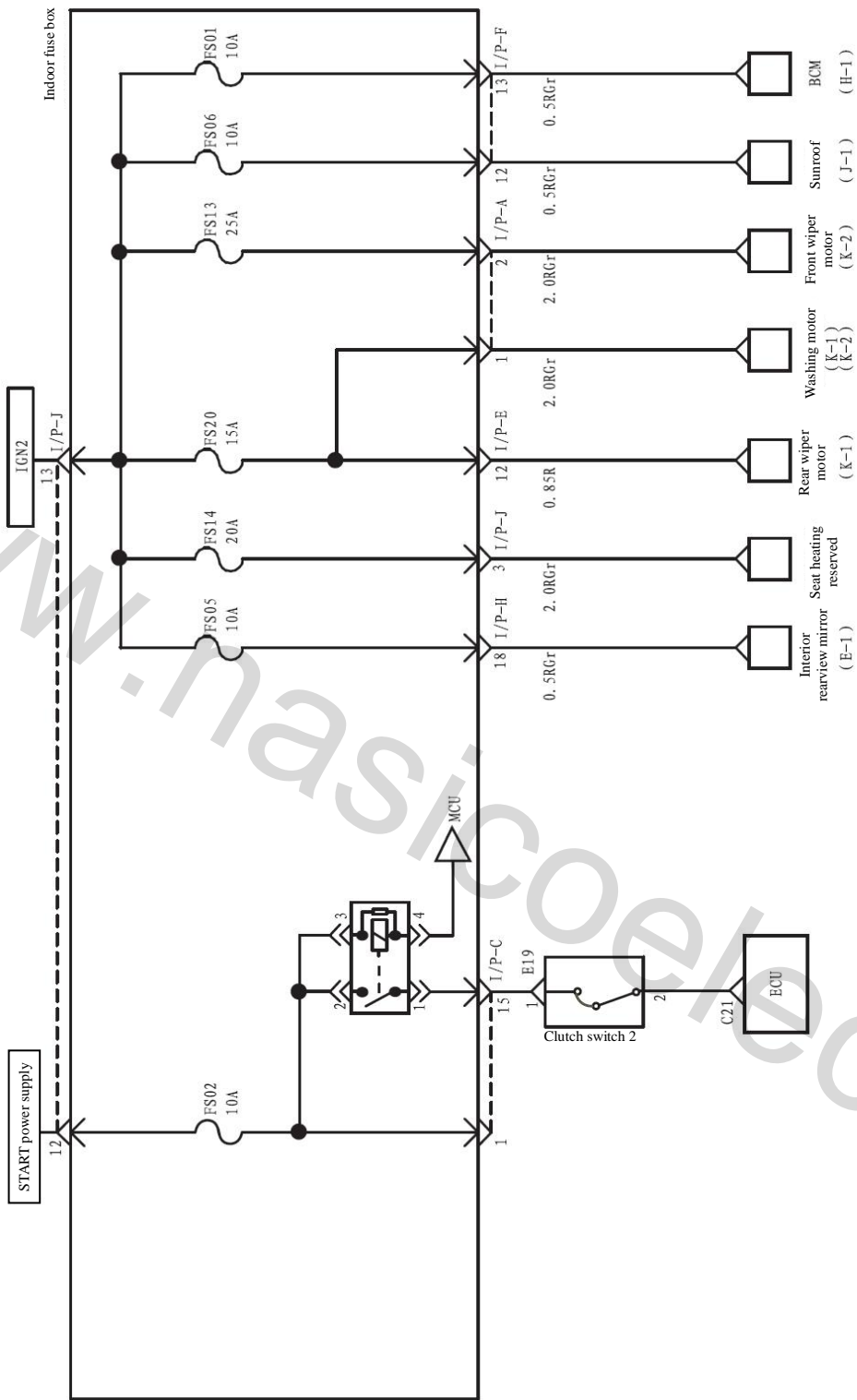

www.nastir.com

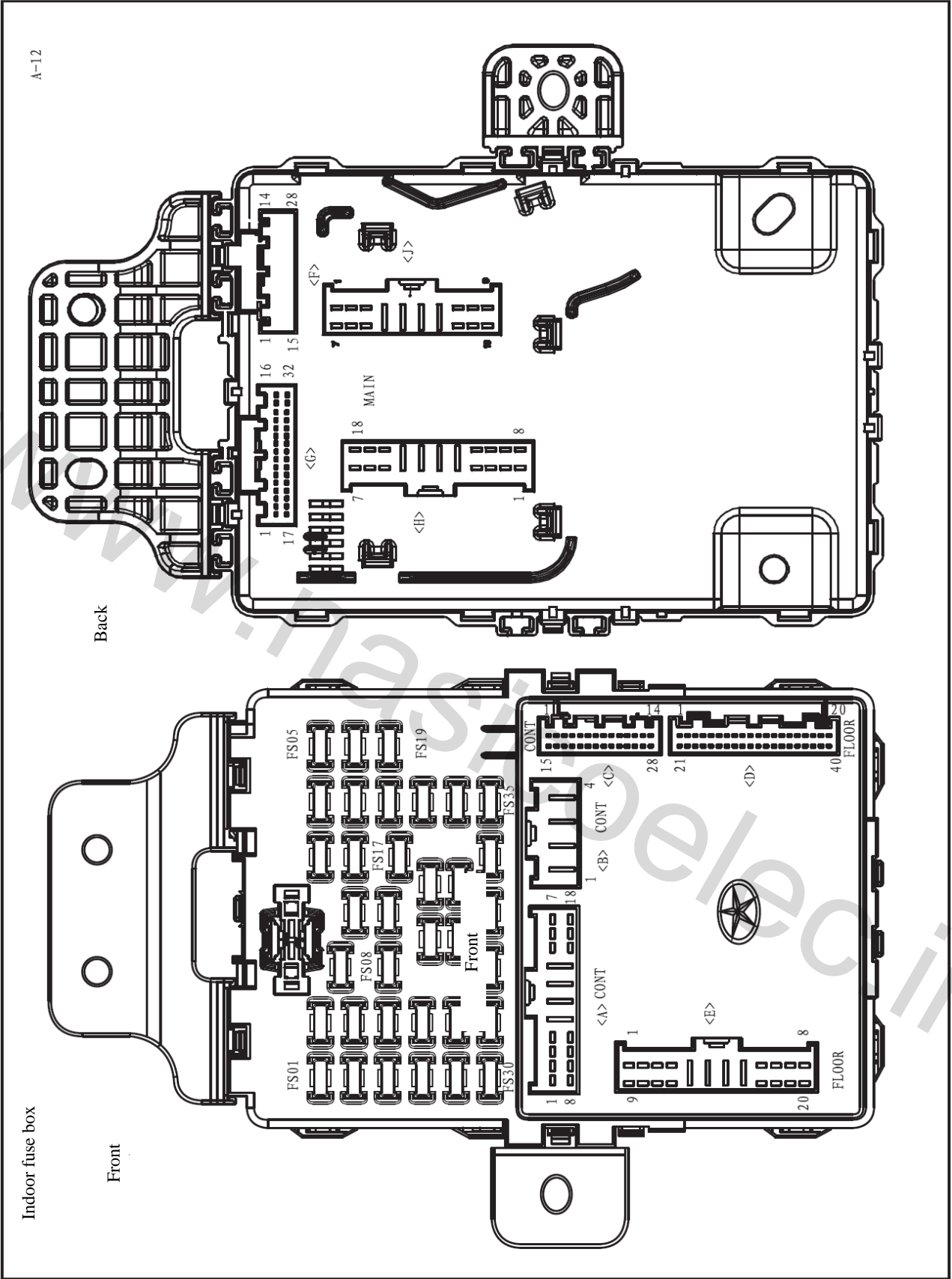

A-12

Back

Indoor fuse box

Front

A-13

Indoor fuse box BCM

Body controller BCM	FS01 1.0A	FS02 1.0A	Radio	PS01 1.5A	Instrument	FS03 1.0A	Instrument	FS04 1.0A	Interior rearview mirror P/Mir(D)	FS05 1.0A
Sunroof	FS06 1.0A	FS07 1.0A	Radio	FS08 1.0A	Airbag	FS09 1.0A	Front fog lamp	FS11 1.0A	Ceiling light Sunvisor Anti-theft Diagnostic interface	FS12 1.0A
Front wiper	FS13 2.5A	FS14 2.0A	Cigarette lighter	FS15 1.5A	On-board power	FS16 1.5A	Door lock	FS18 2.0A	Body control system BCM	FS19 1.0A
RR wiper	FS20 1.5A	FS21 2.0A	Electric-injection system(EMS) Electric vacuum system(EMS)	FS22 2.5A	Reserved	FS23 1.0A	Body controller	FS24 1.5A		
Glass UP	FS25 2.5A	FS26 1.0A	Electric seat	FS27 2.5A	Tire pressure monitoring TPMS	FS28 1.0A	Reserved	FS29 1.5A		
Glass DOWN	FS30 2.5A	FS31 1.5A	Heating wire	FS32 1.0A	Shift mechanism	FS34 1.0A	Flasher	FS35 2.0A		
					Anti-clip motor	FS33 2.5A				

Item	Remarks
A	Front compartment wire harness
B	Front compartment wire harness
C	Front compartment wire harness
D	Floor wire harness
E	Floor wire harness
F	Major wire harness
G	Major wire harness
H	Major wire harness
J	Major wire harness

Indoor fuse box

A-14

Indoor Assistant-terminal box

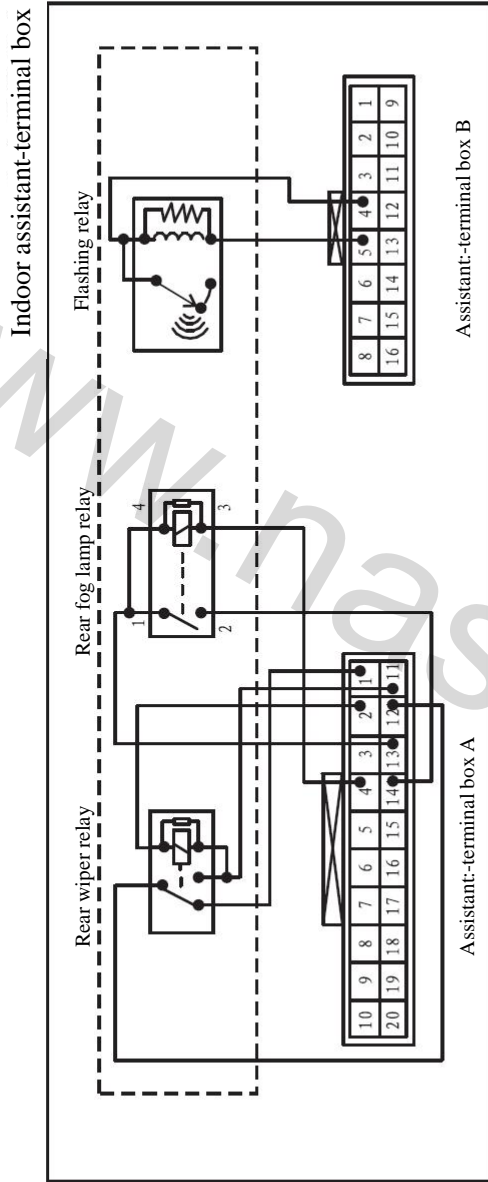

www.asicoelec.ir

A-15

Outdoor fuse box

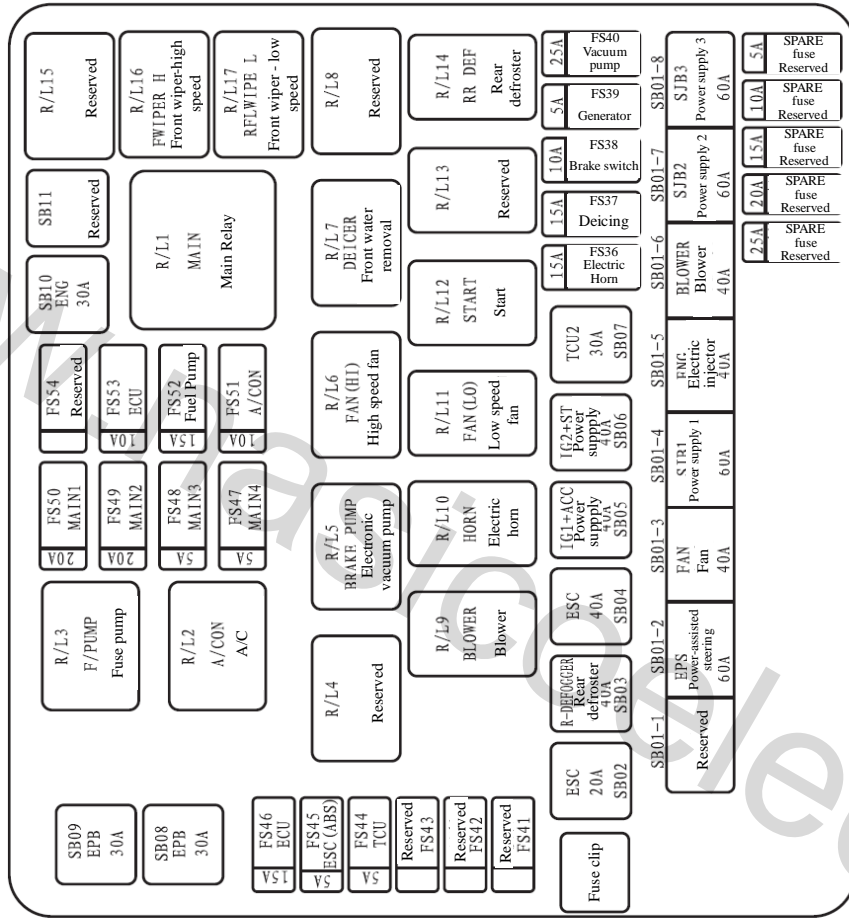

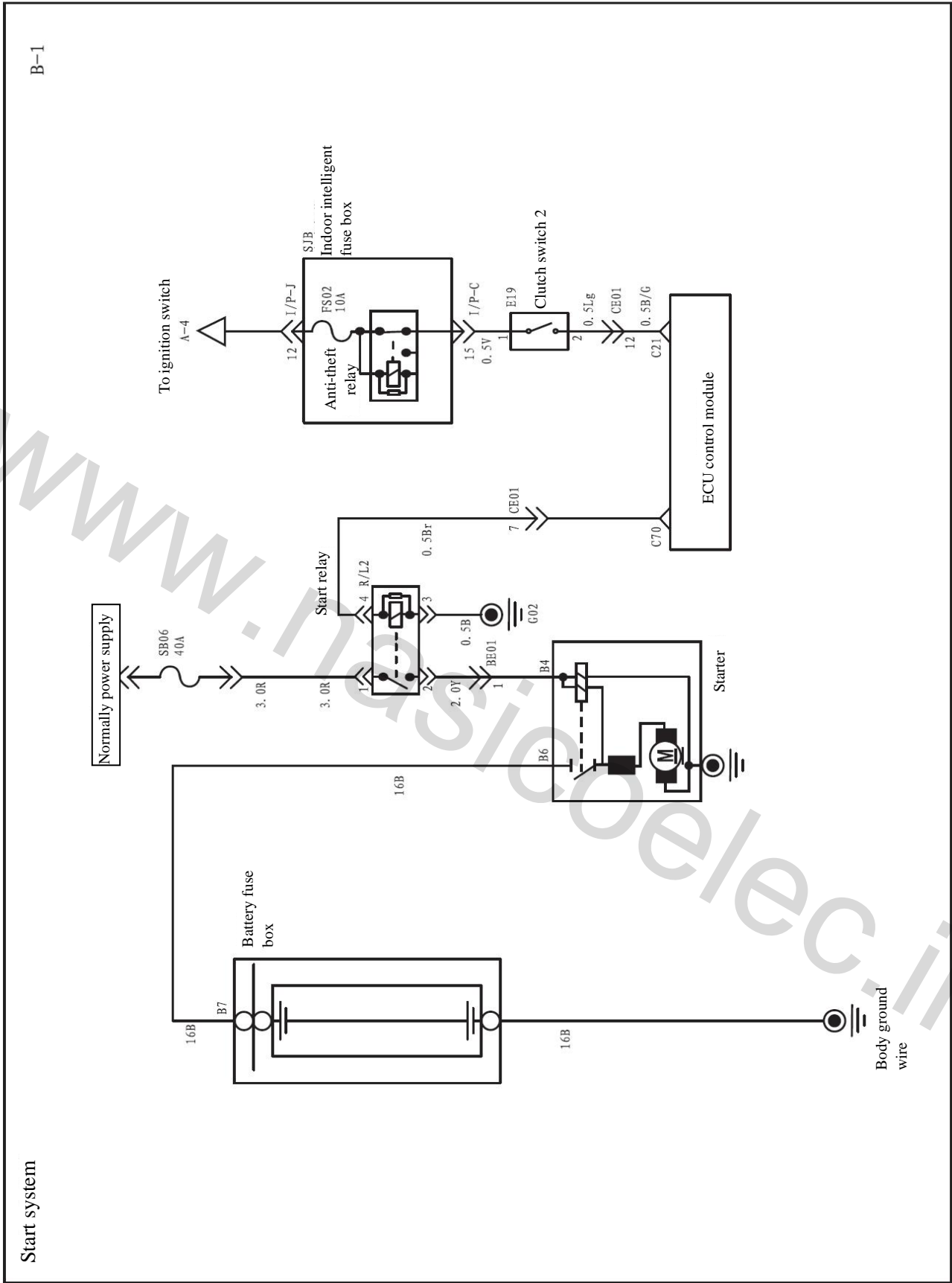

B-1

Start system

C-1

Charging system

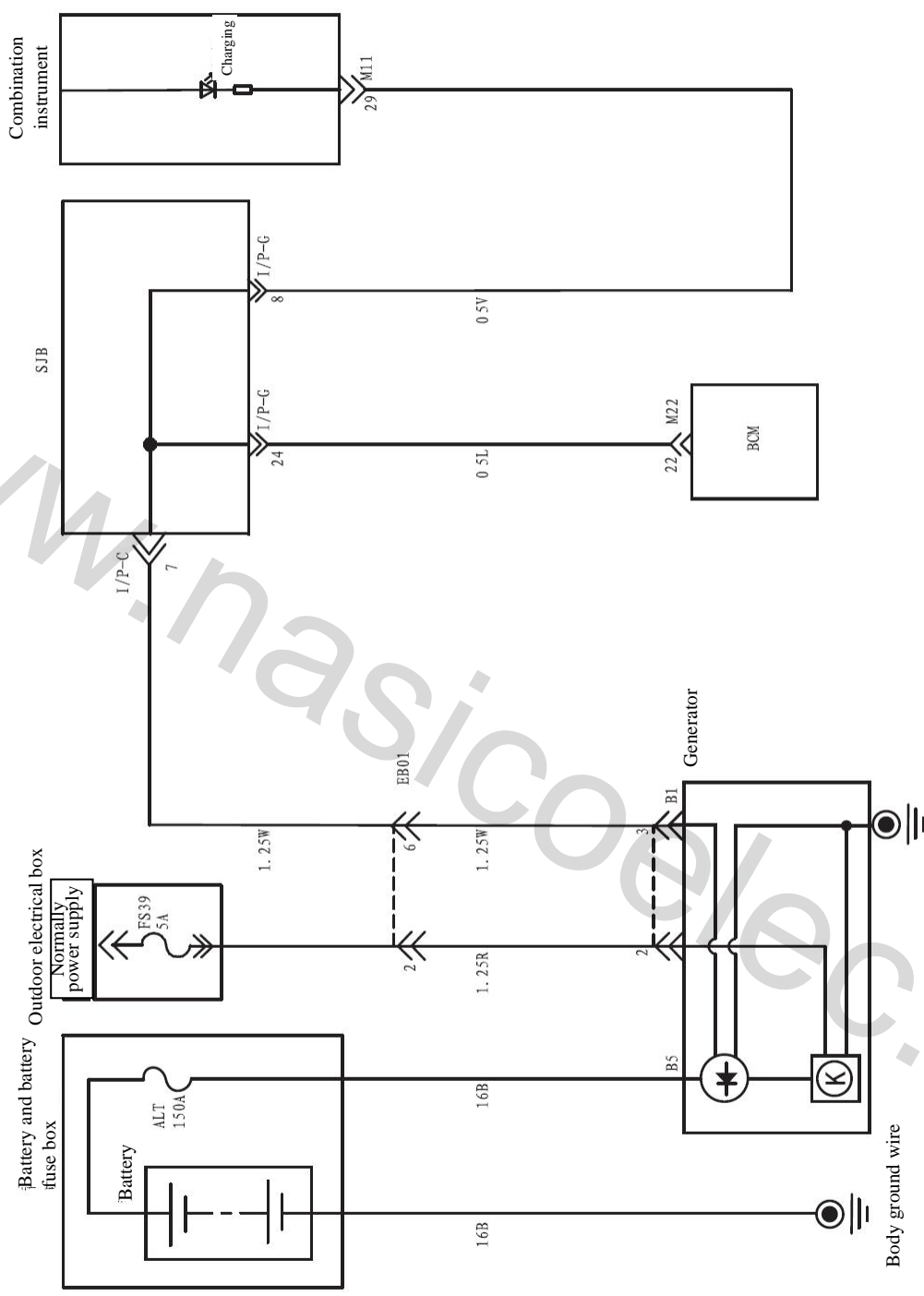

www.nasico.org

D-1

Electric control system (1)

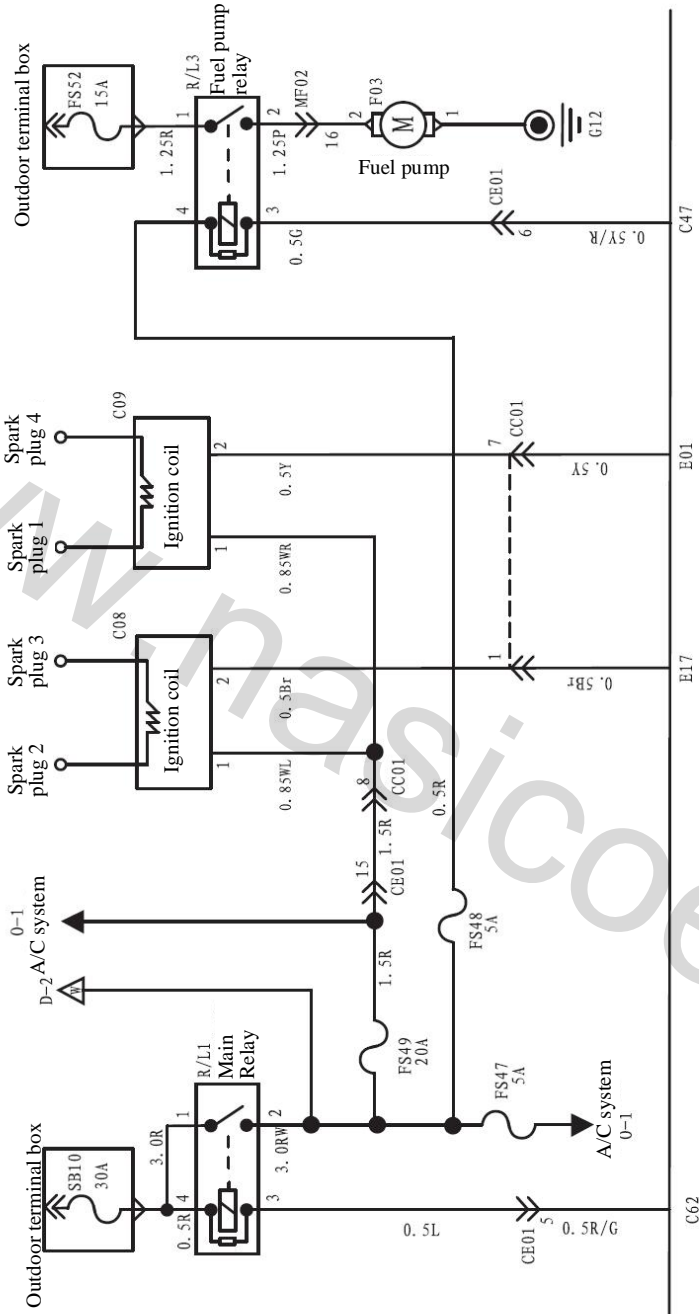

ECU

C62

C47

E01

E17

A/C system 0-1

0.5L

0.5R/G

CE01

0.5R

0.85WL

0.5Br

0.85WR

0.5Y

0.5Y

0.5Y/R

0.5G

MF02

F03

CE01

0.5R

1.5R

1.5R

1.5R

1.5R

1.25R

1.25R

1.25R

1.25R

1.25R

1.25R

1.25R

1.25R

1.25R

1.25R

1.25R

1.25R

1.25R

1.25R

1.25R

1.25R

1.25R

1.25R

1.25R

1.25R

1.25R

1.25R

1.25R

1.25R

1.25R

1.25R

1.25R

1.25R

1.25R

1.25R

1.25R

1.25R

1.25R

1.25R

1.25R

1.25R

1.25R

1.25R

1.25R

1.25R

1.25R

1.25R

1.25R

1.25R

1.25R

1.25R

1.25R

1.25R

1.25R

1.25R

1.25R

1.25R

1.25R

1.25R

1.25R

1.25R

1.25R

1.25R

1.25R

1.25R

1.25R

1.25R

1.25R

1.25R

1.25R

1.25R

1.25R

1.25R

1.25R

1.25R

1.25R

1.25R

1.25R

1.25R

1.25R

1.25R

1.25R

1.25R

1.25R

1.25R

1.25R

1.25R

1.25R

1.25R

1.25R

1.25R

1.25R

1.25R

1.25R

1.25R

1.25R

1.25R

1.25R

1.25R

1.25R

1.25R

1.25R

1.25R

1.25R

1.25R

1.25R

1.25R

1.25R

1.25R

1.25R

1.25R

1.25R

1.25R

1.25R

1.25R

1.25R

1.25R

1.25R

1.25R

1.25R

1.25R

1.25R

1.25R

1.25R

1.25R

1.25R

1.25R

1.25R

1.25R

1.25R

1.25R

1.25R

1.25R

1.25R

1.25R

1.25R

1.25R

1.25R

1.25R

1.25R

1.25R

1.25R

1.25R

1.25R

1.25R

1.25R

1.25R

1.25R

1.25R

1.25R

1.25R

1.25R

1.25R

1.25R

1.25R

1.25R

1.25R

1.25R

1.25R

1.25R

1.25R

1.25R

1.25R

1.25R

1.25R

1.25R

1.25R

1.25R

1.25R

1.25R

1.25R

1.25R

D-2

Electric control system (2)

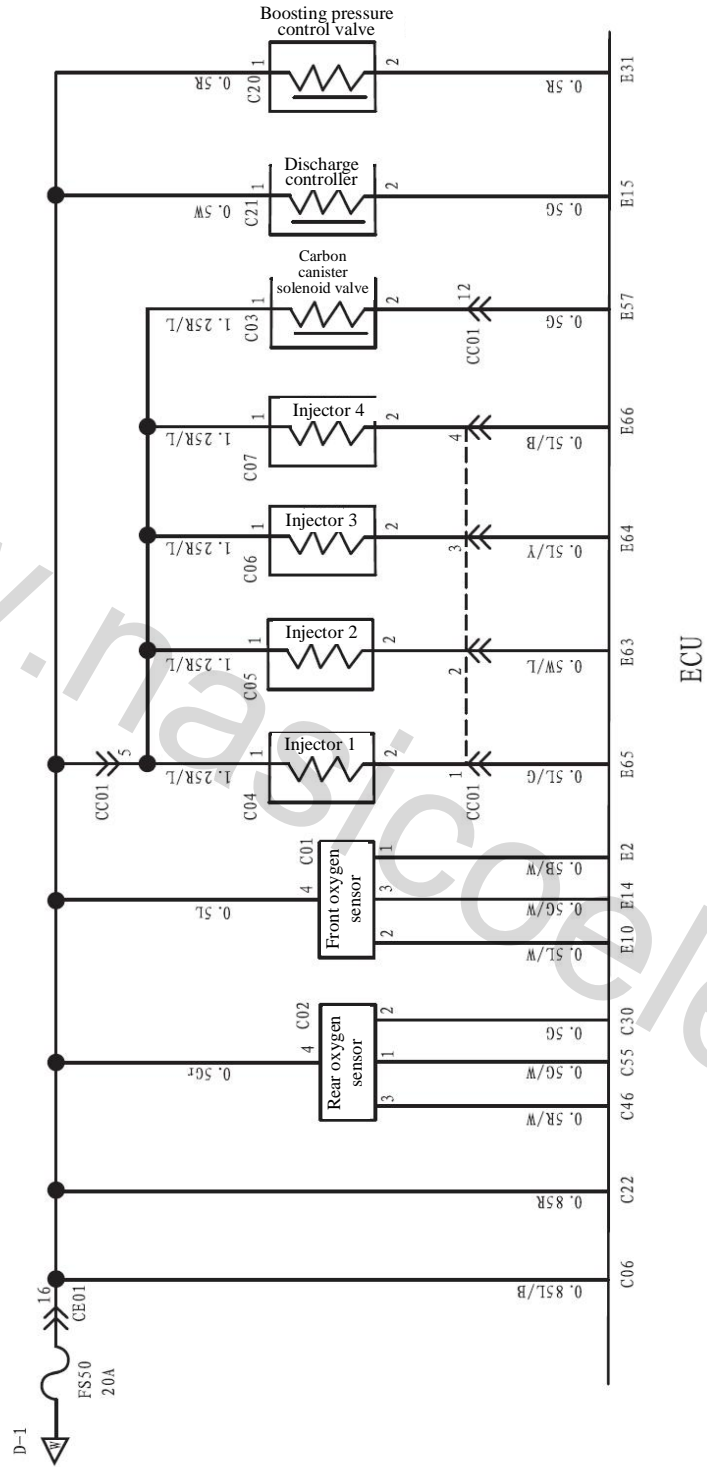

D-3

Electric control system (3)

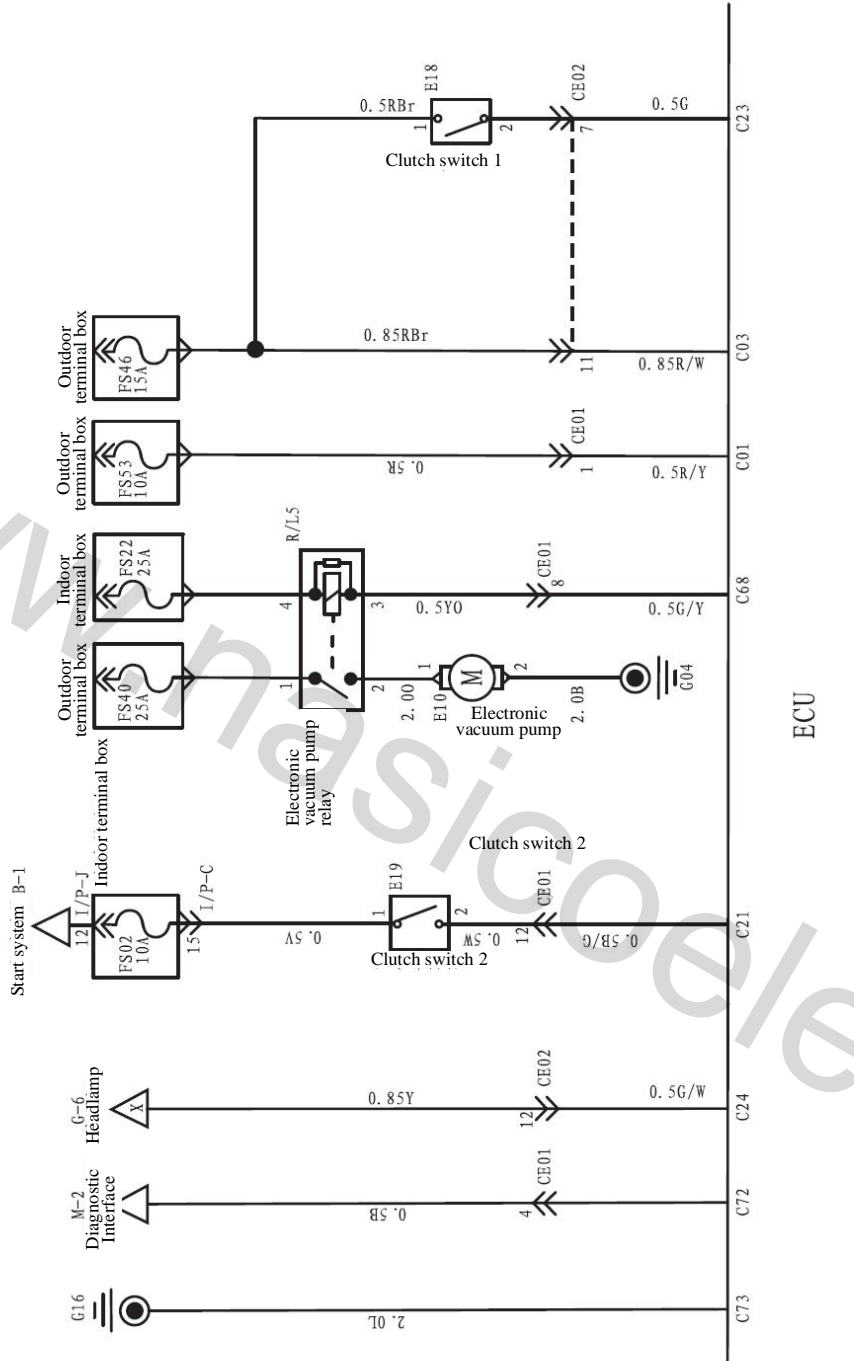

ECU

D-4

Electric control system (4)

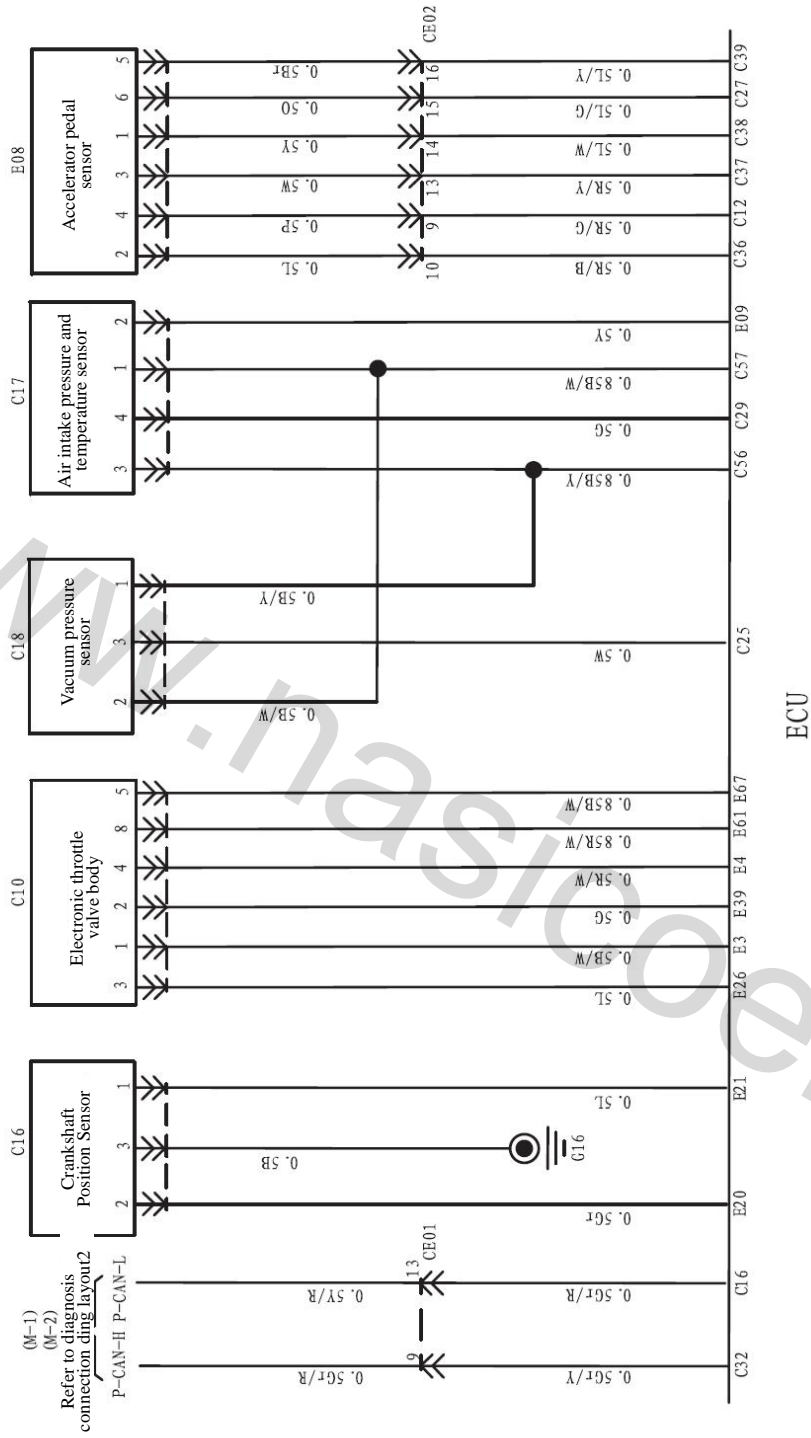

www.nasir-elec.ir

D-5

Electric control system (5)

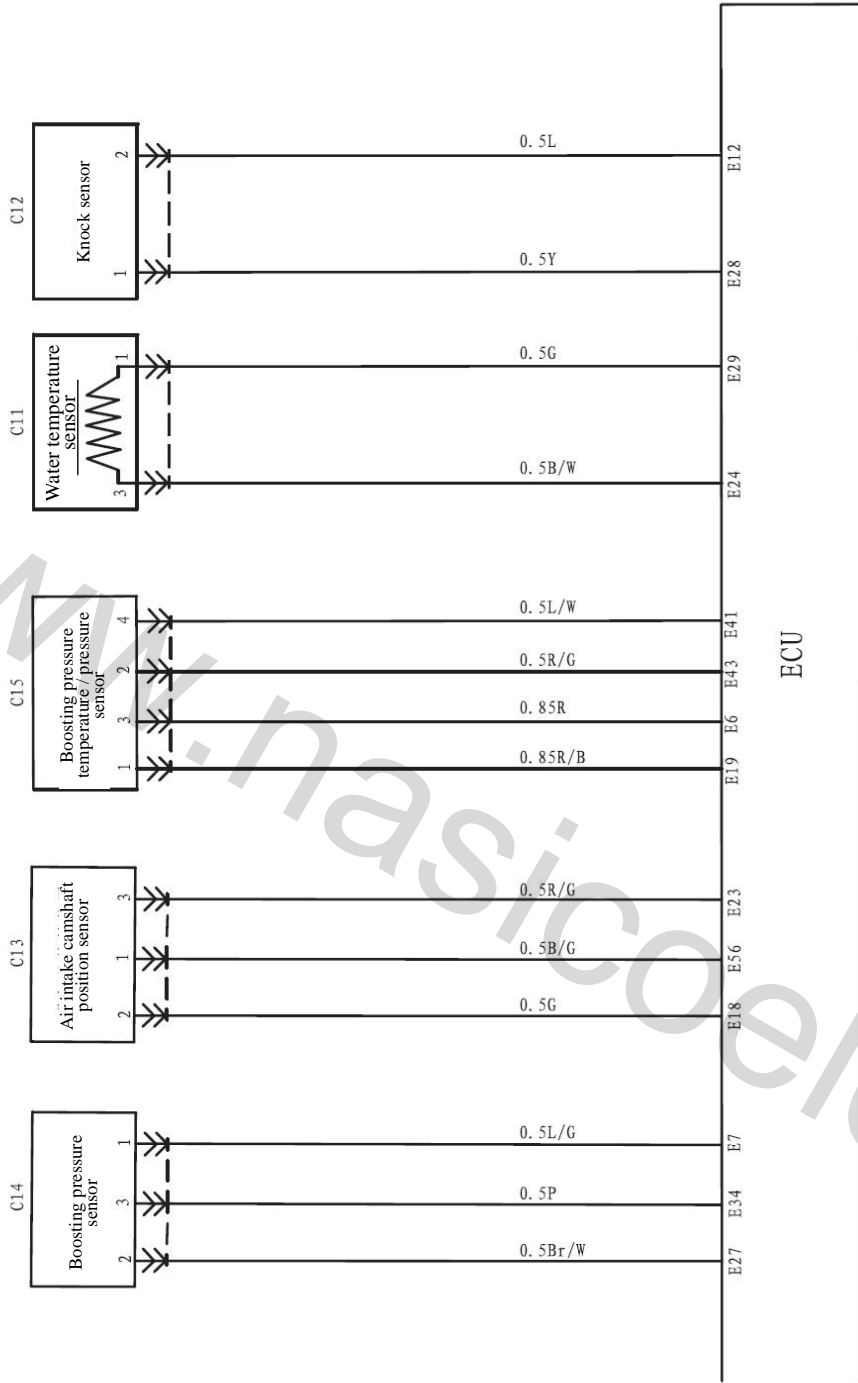

ECU

www.nasicoelec.ir

E-1

Reversing radar system

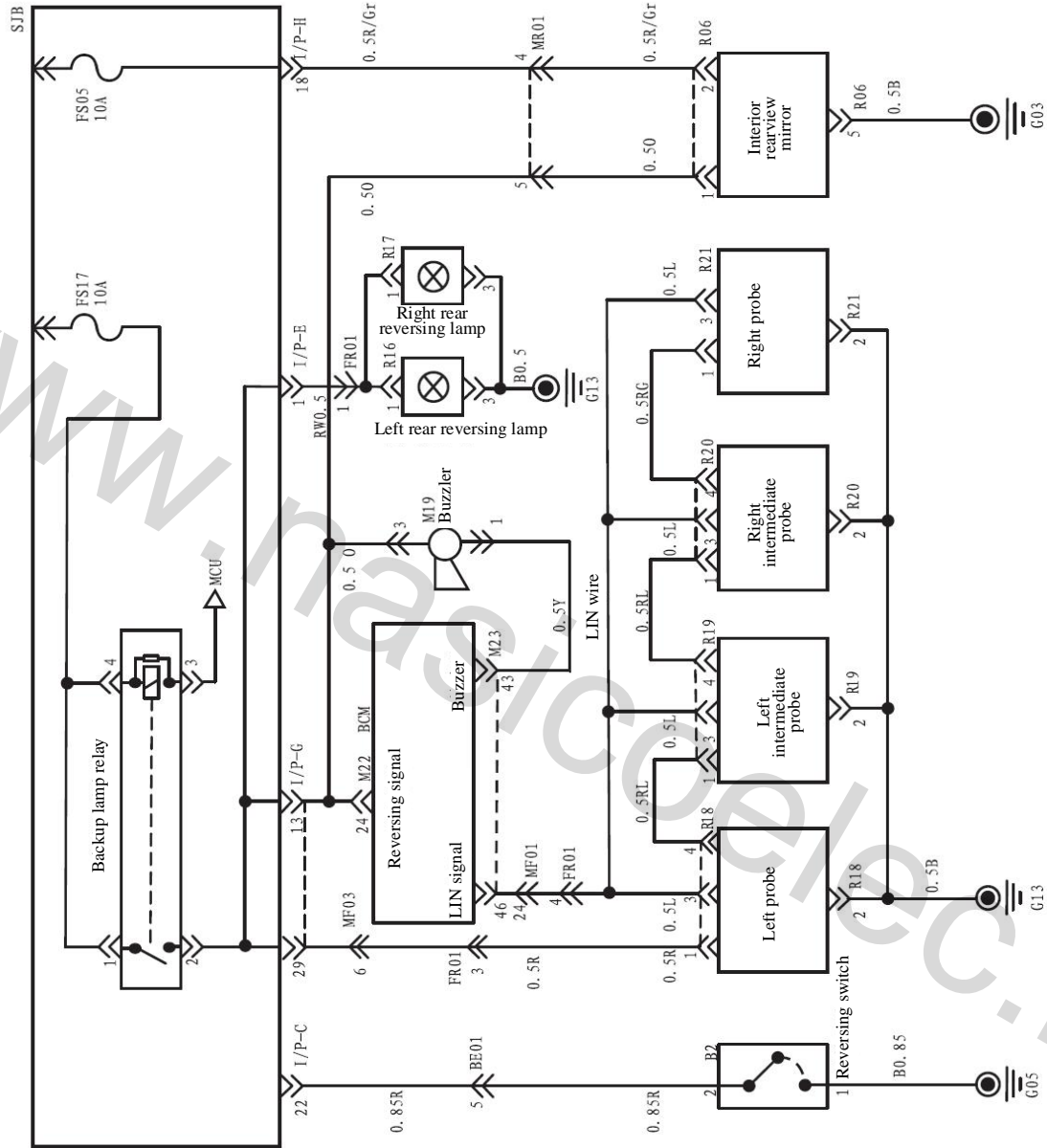

F-1

Audio System

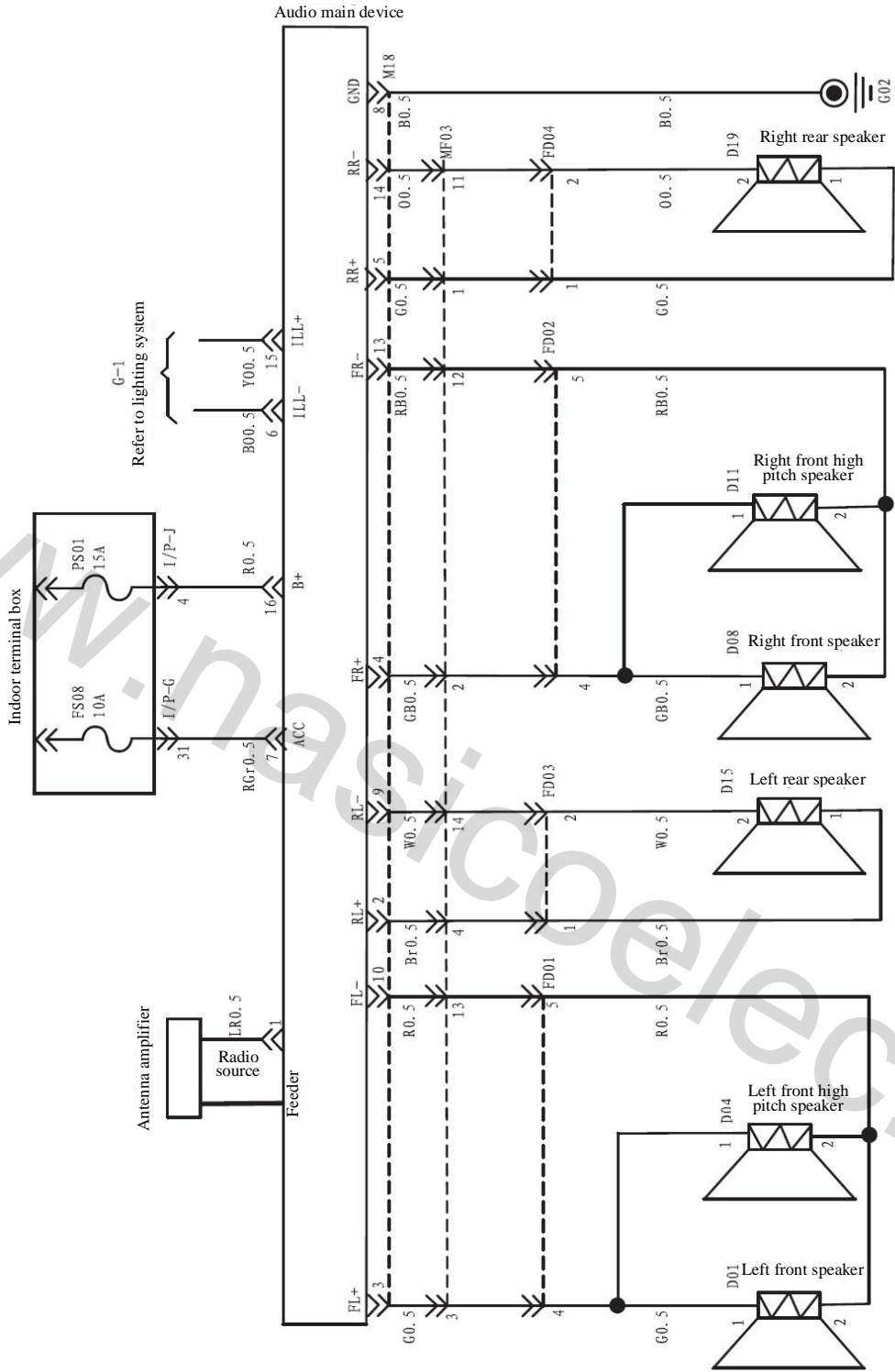

G-1

Headlamp (Small light)

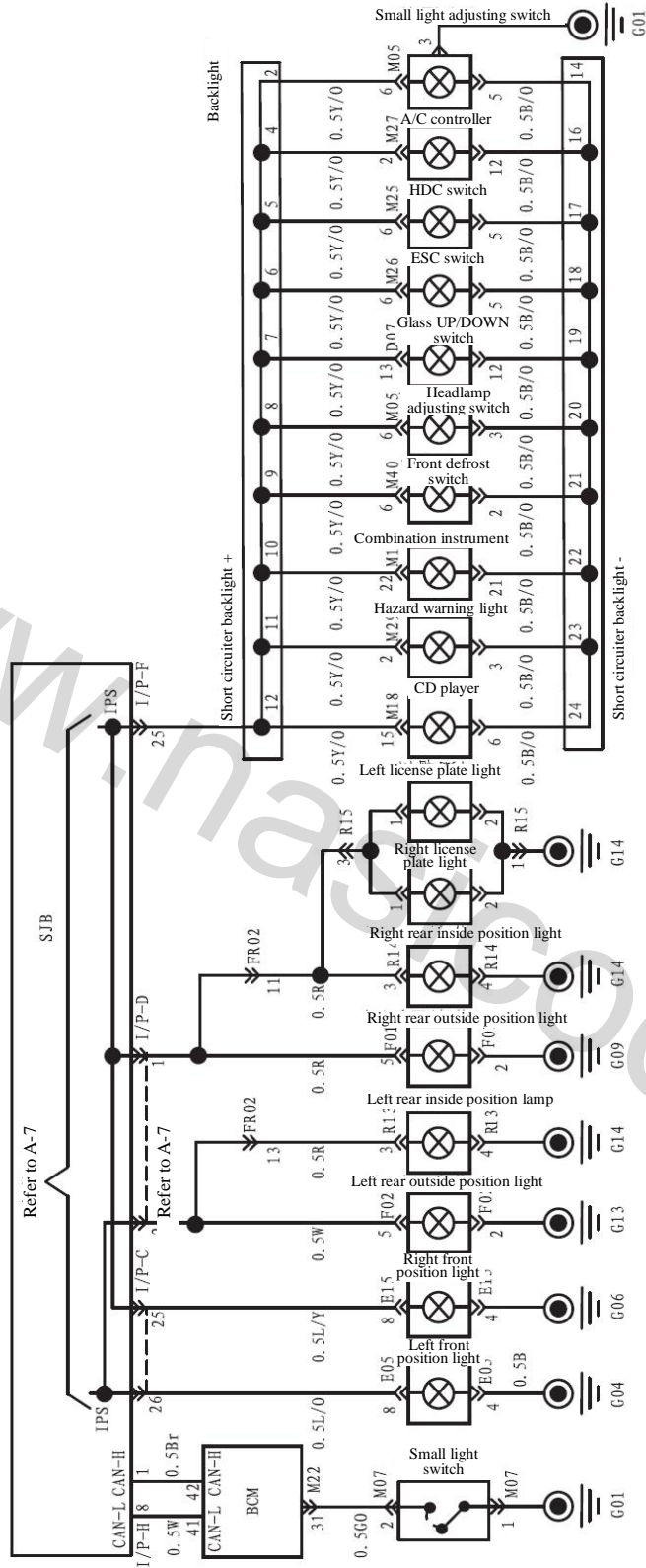

G-2

Rear fog lamp

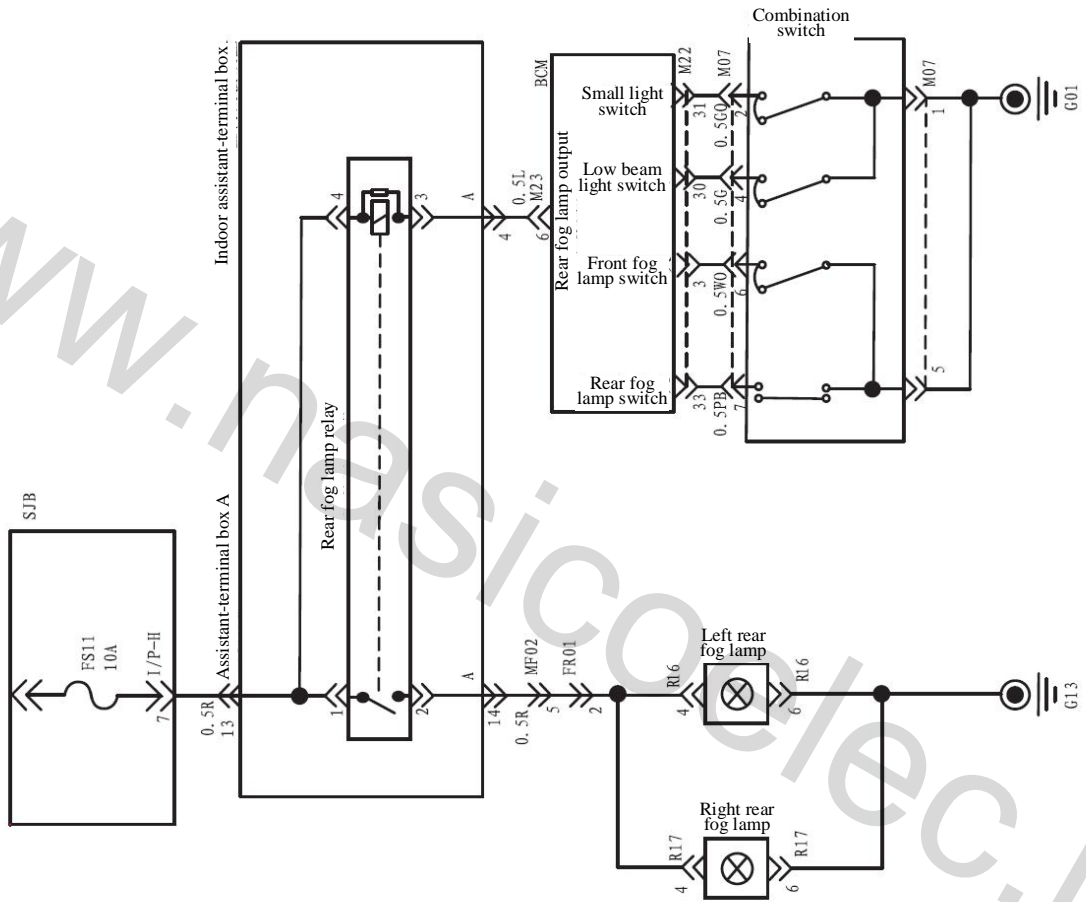

G-3

Turning light and hazard warning light

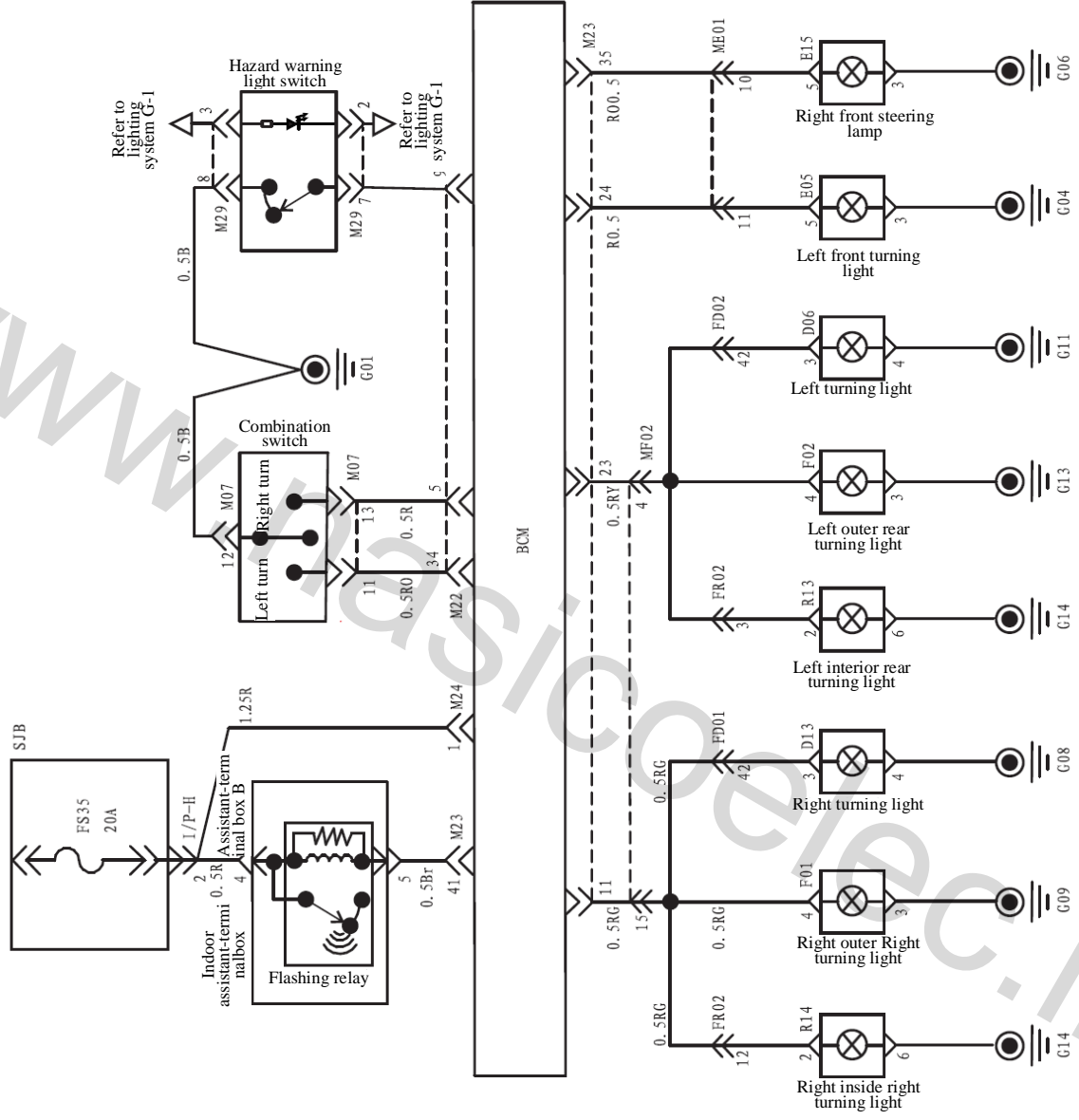

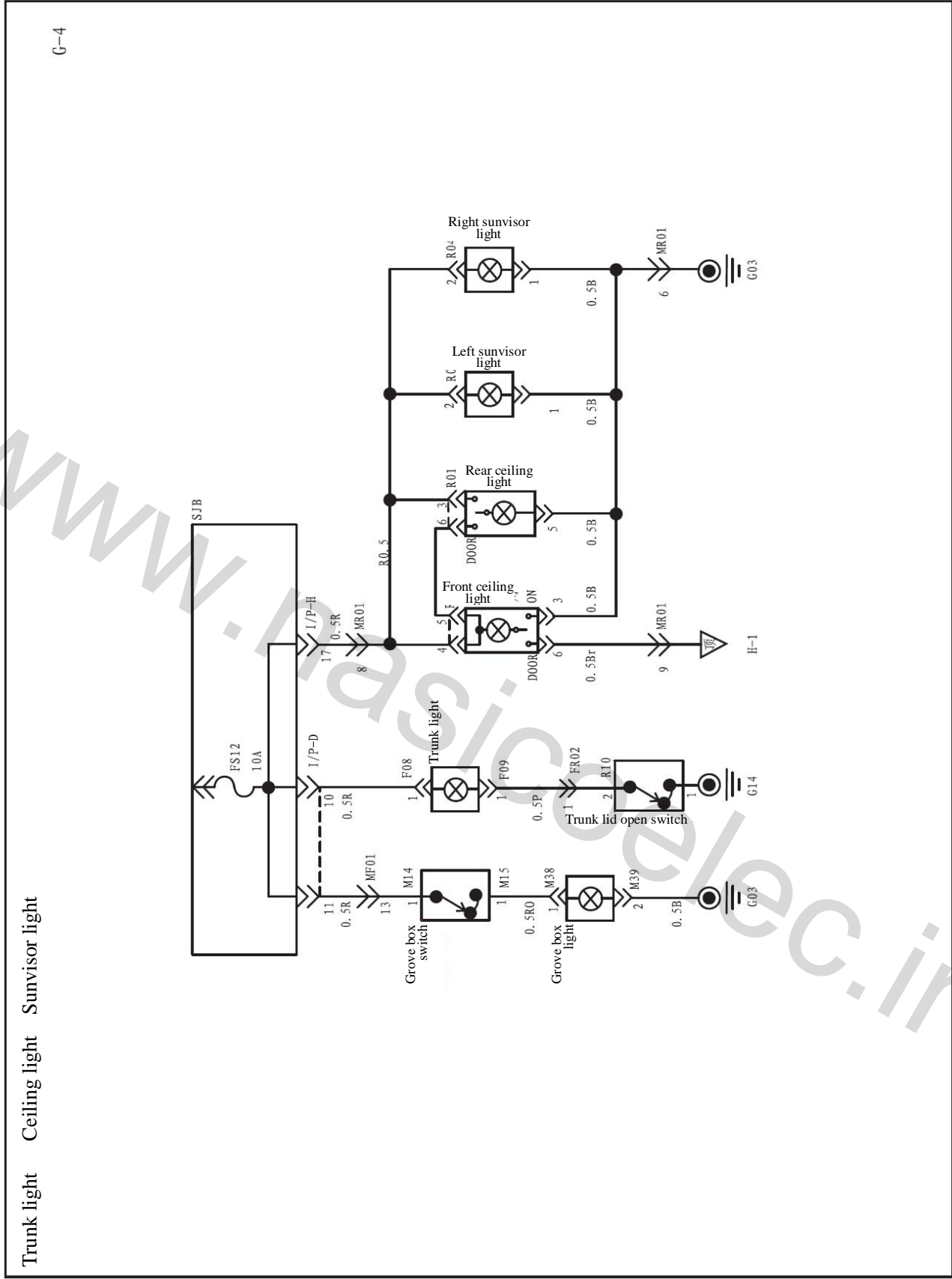

Trunk light Ceiling light Sunvisor light

G-4

G-5

Door light

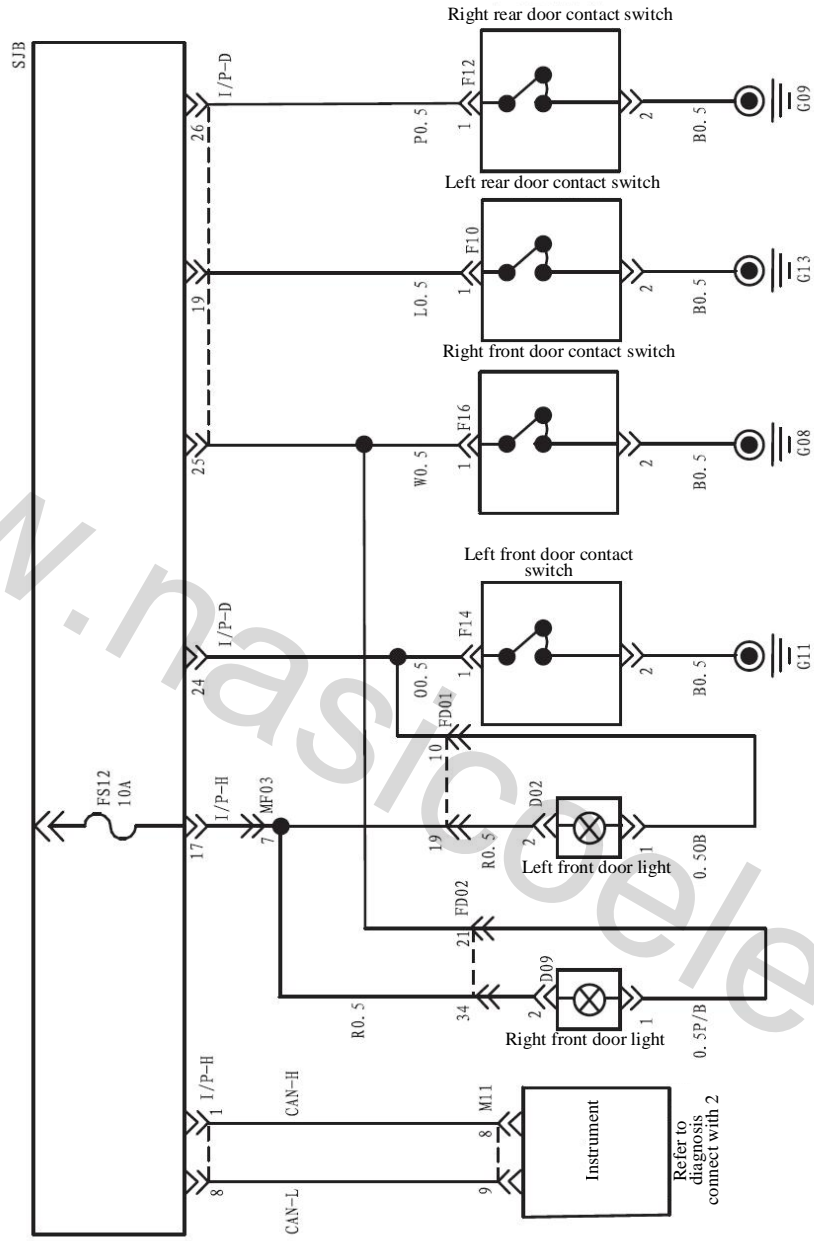

www.parsic.ac.ir

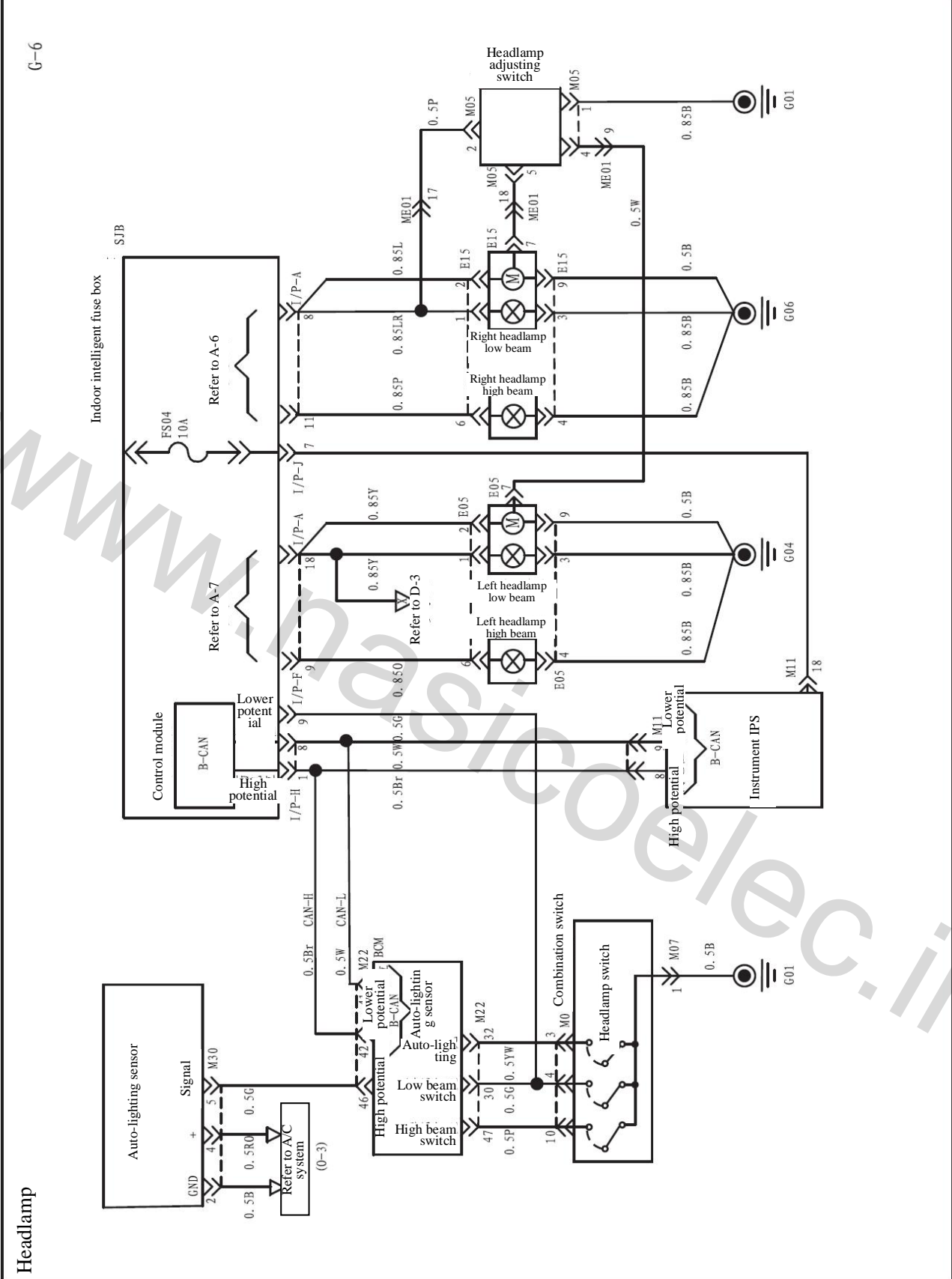

G-6

Headlamp

G-7

Front fog lamp

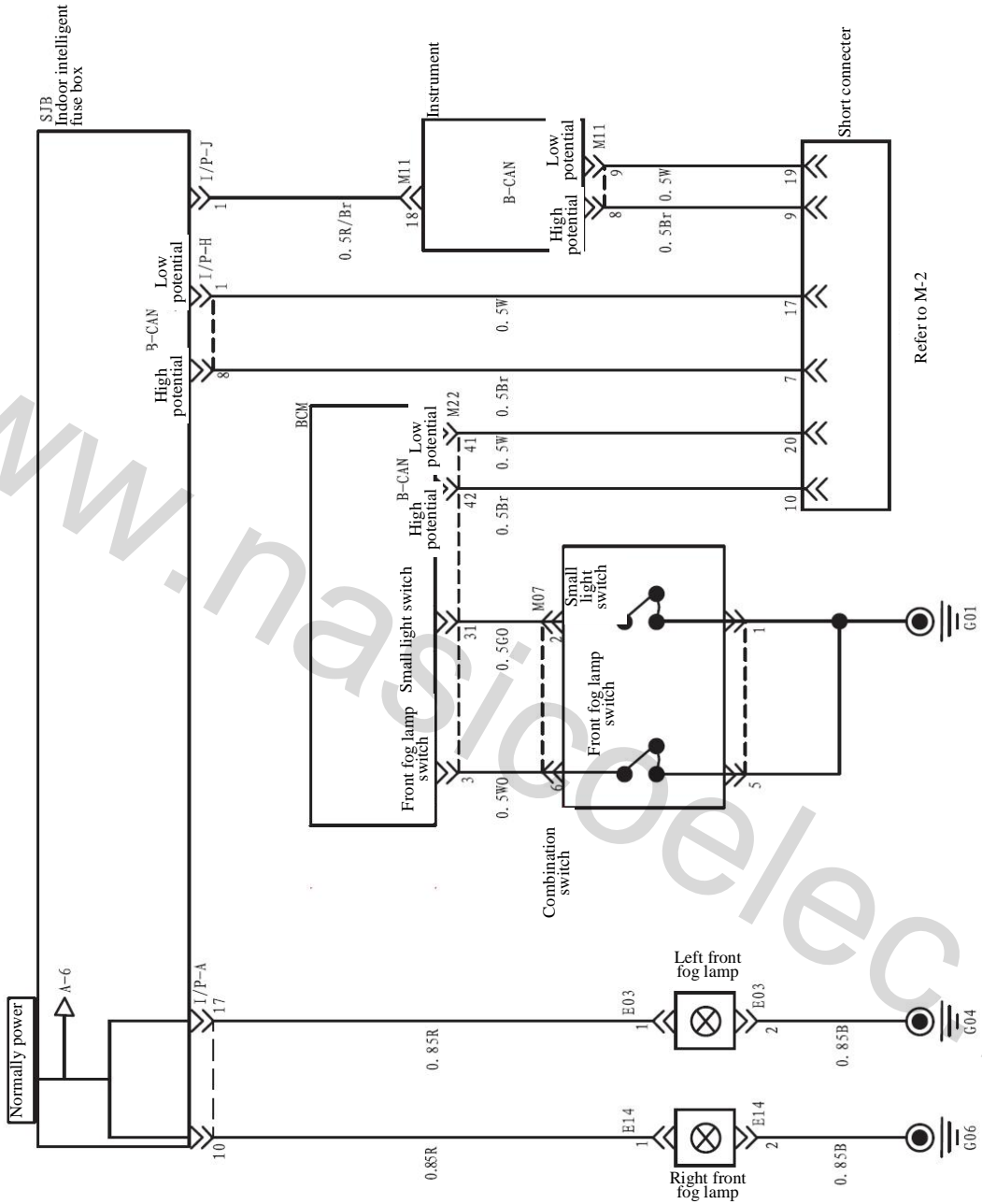

G-8

Front window deicing and rearview mirror defogger

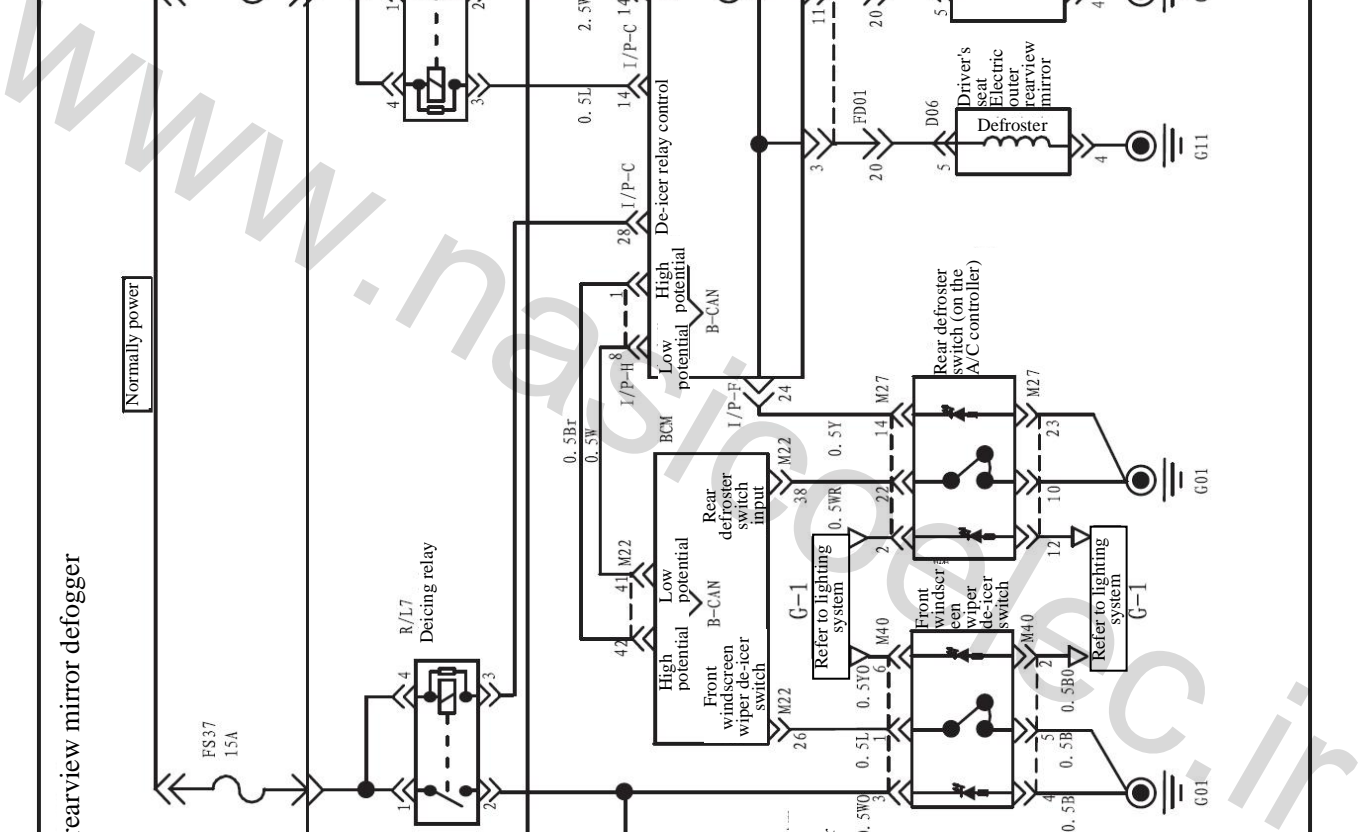
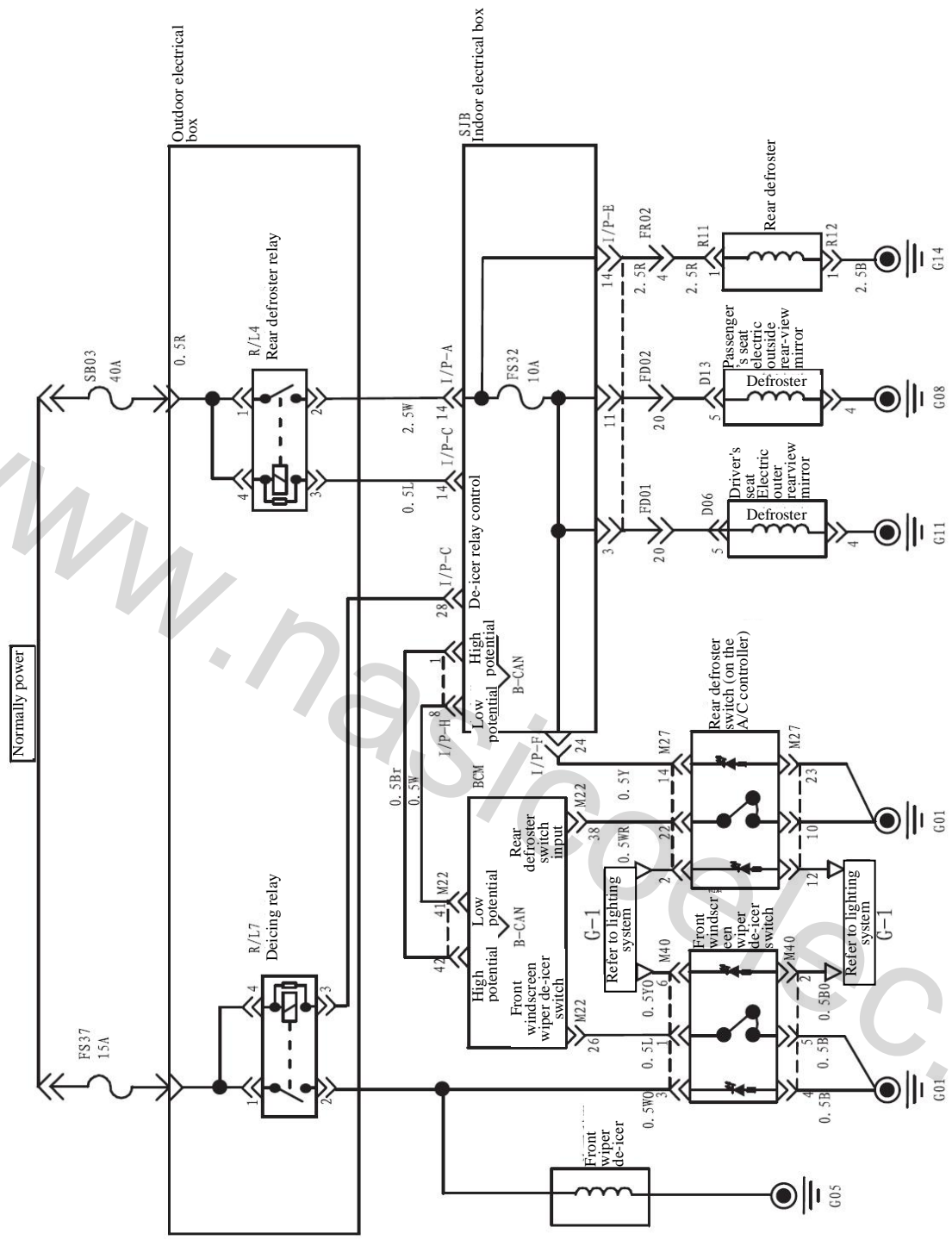

Cigarette lighter On-board power supply

G-9

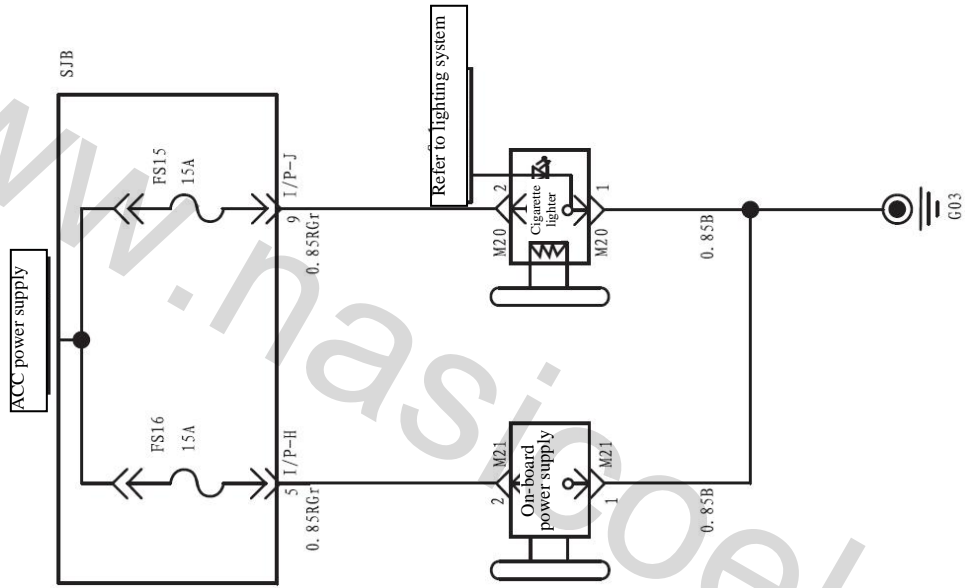

www.nasircoelec.ir

G-10

Electric horn

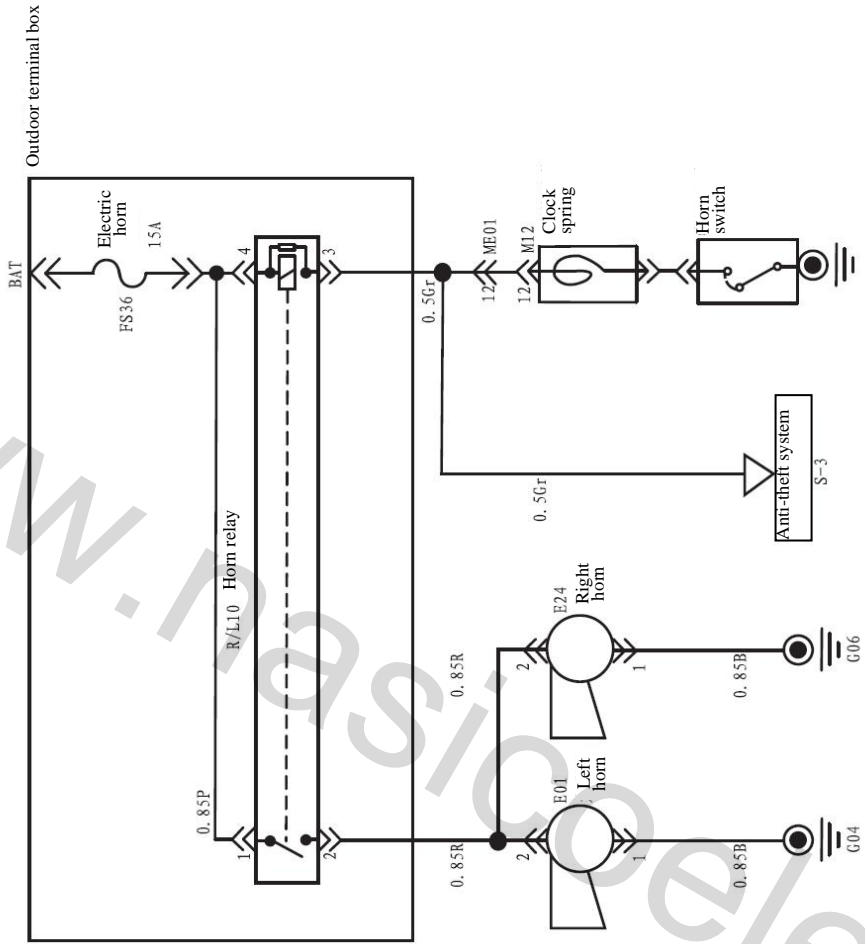

WWW.PASIRI.ELEC.IR

H-1

Body control module (BCM) system (1)

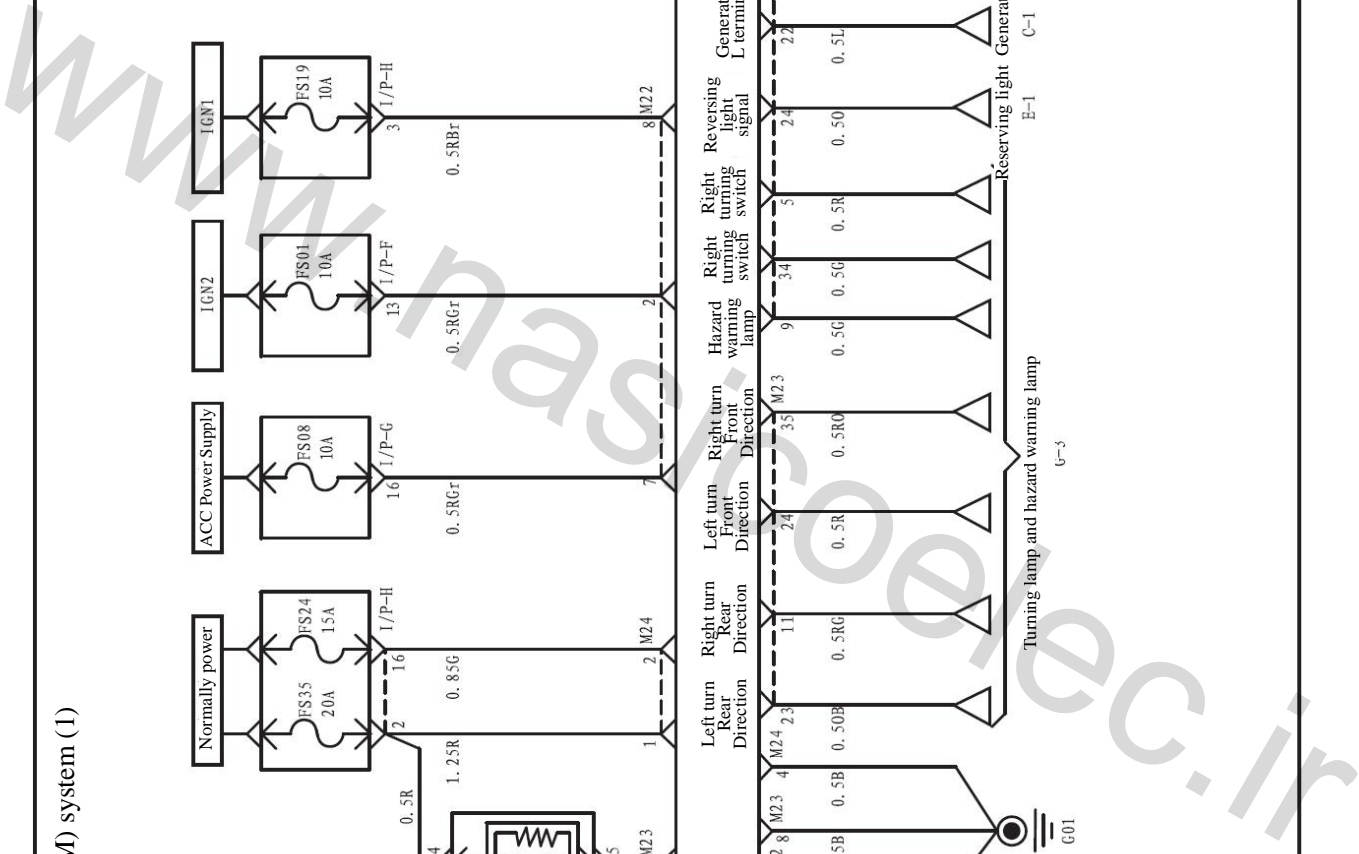
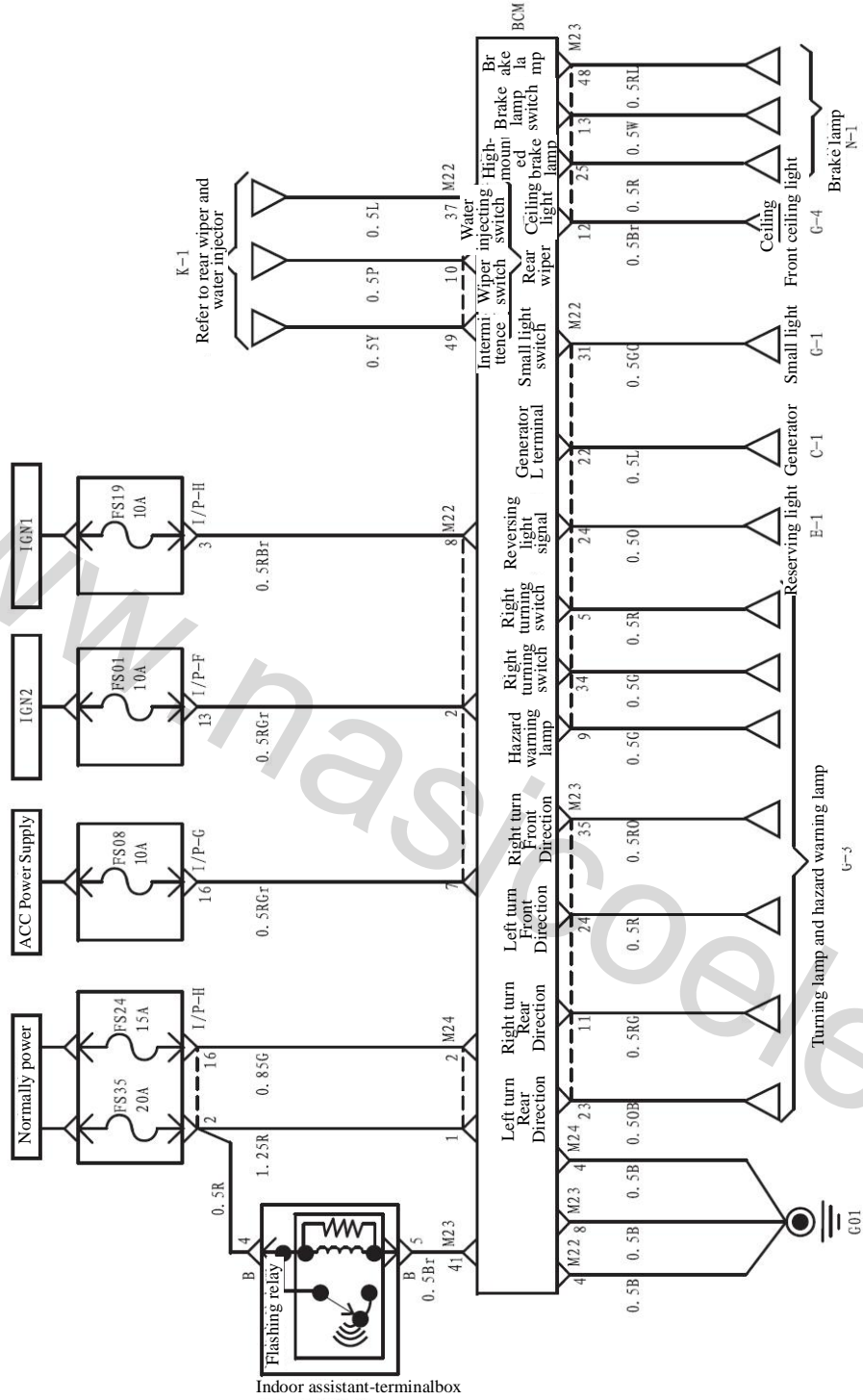

Body control module (BCM) system (2)

H-2

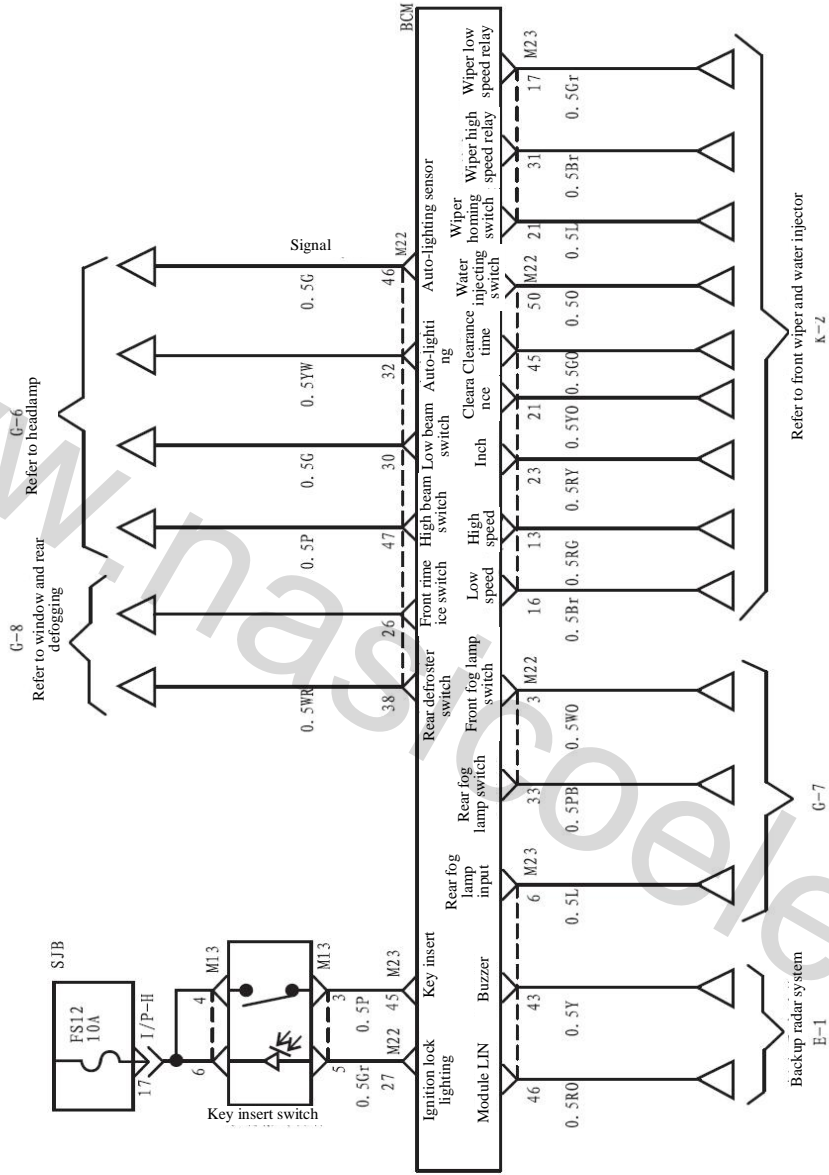

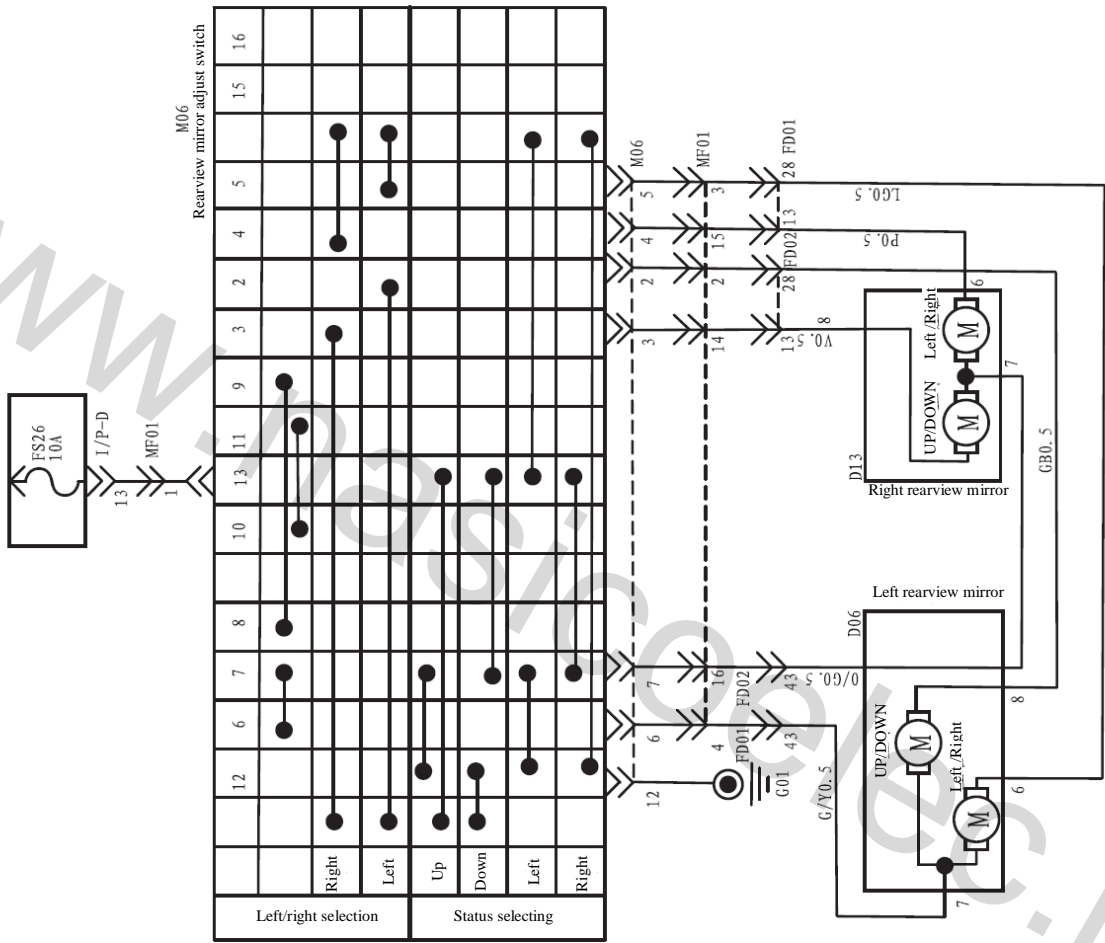

J-1

Sunroof system

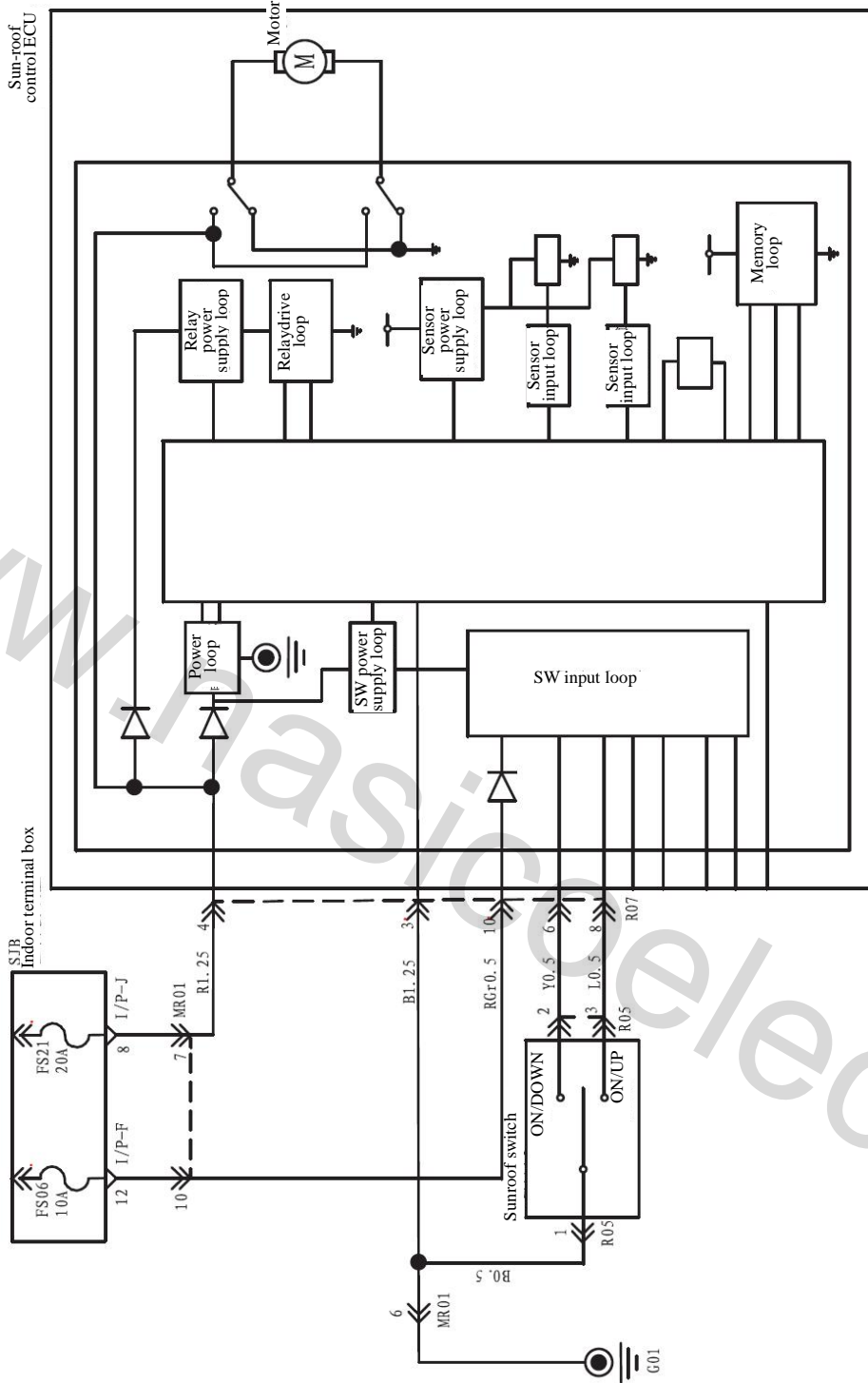

SJB Indoor terminal box

Sun-roof control ECU

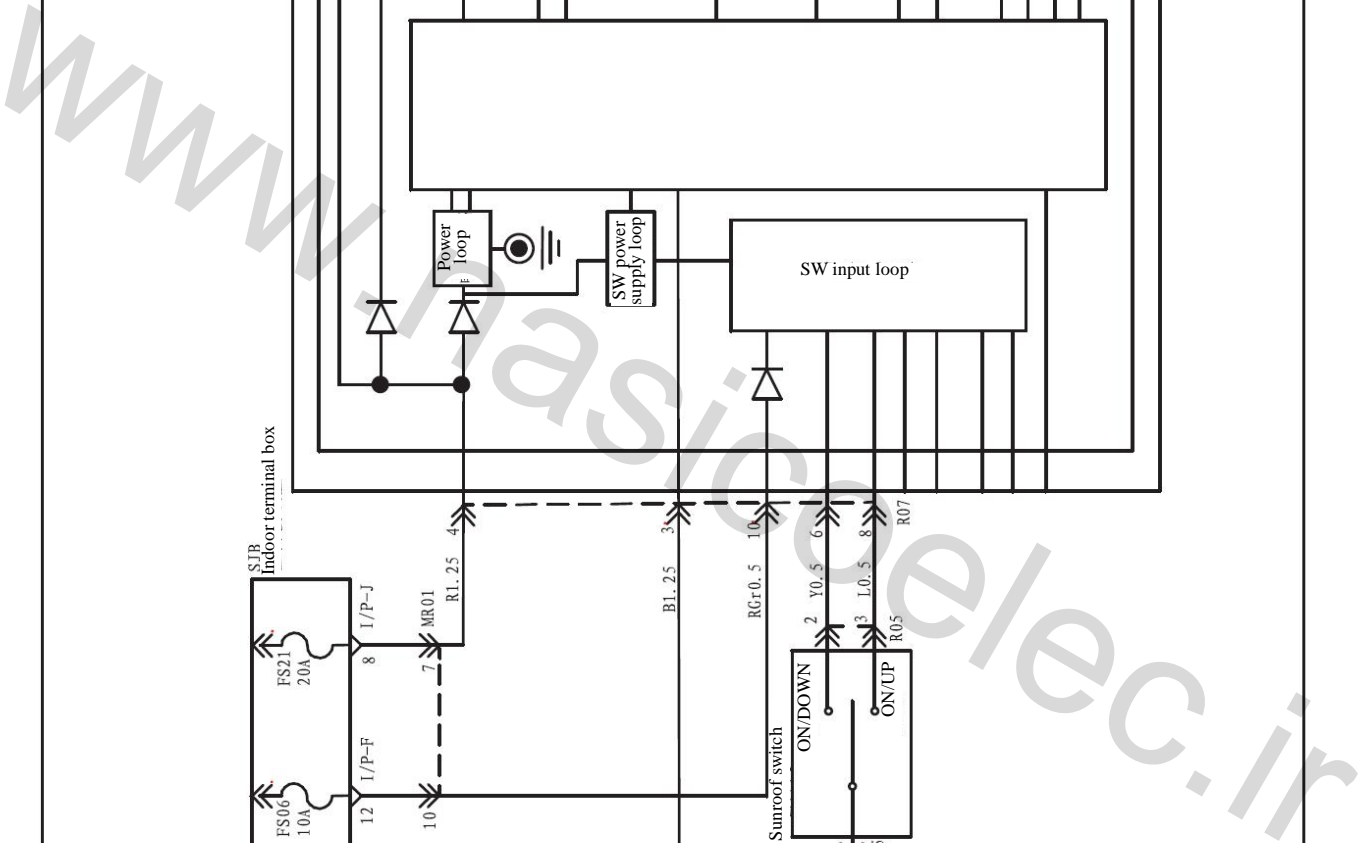

K-1

Rear wiper

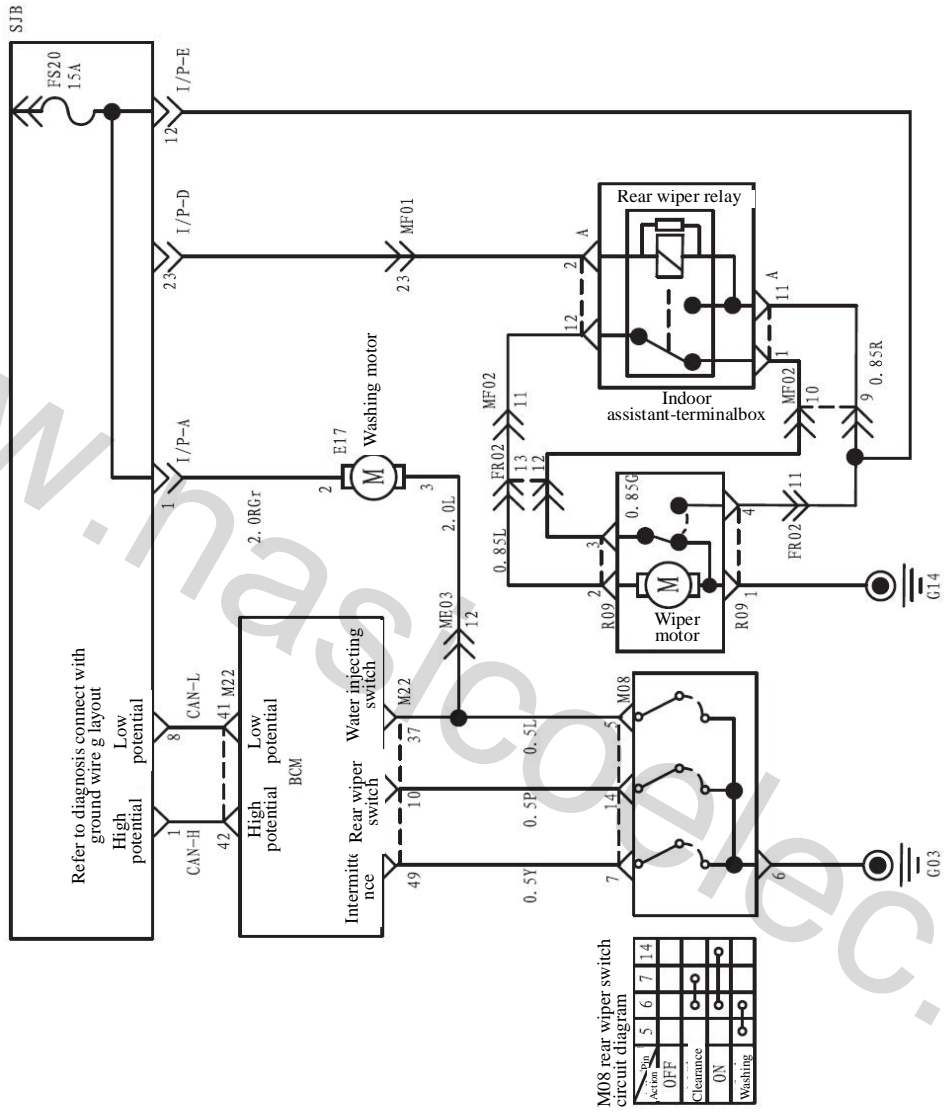

Airbag system (SRS)

L-1

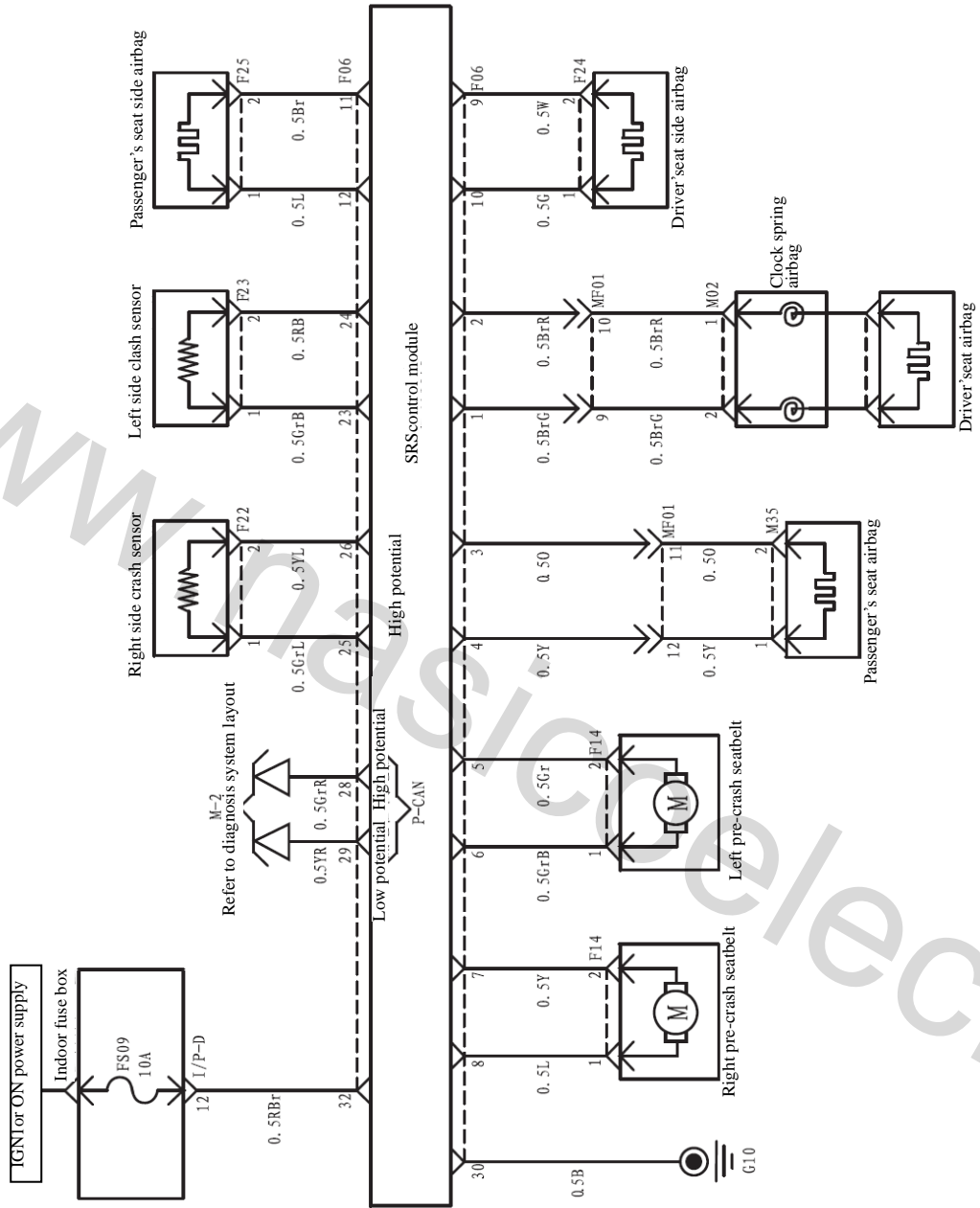

Diagnosis connect with ground wire layout!

M-1

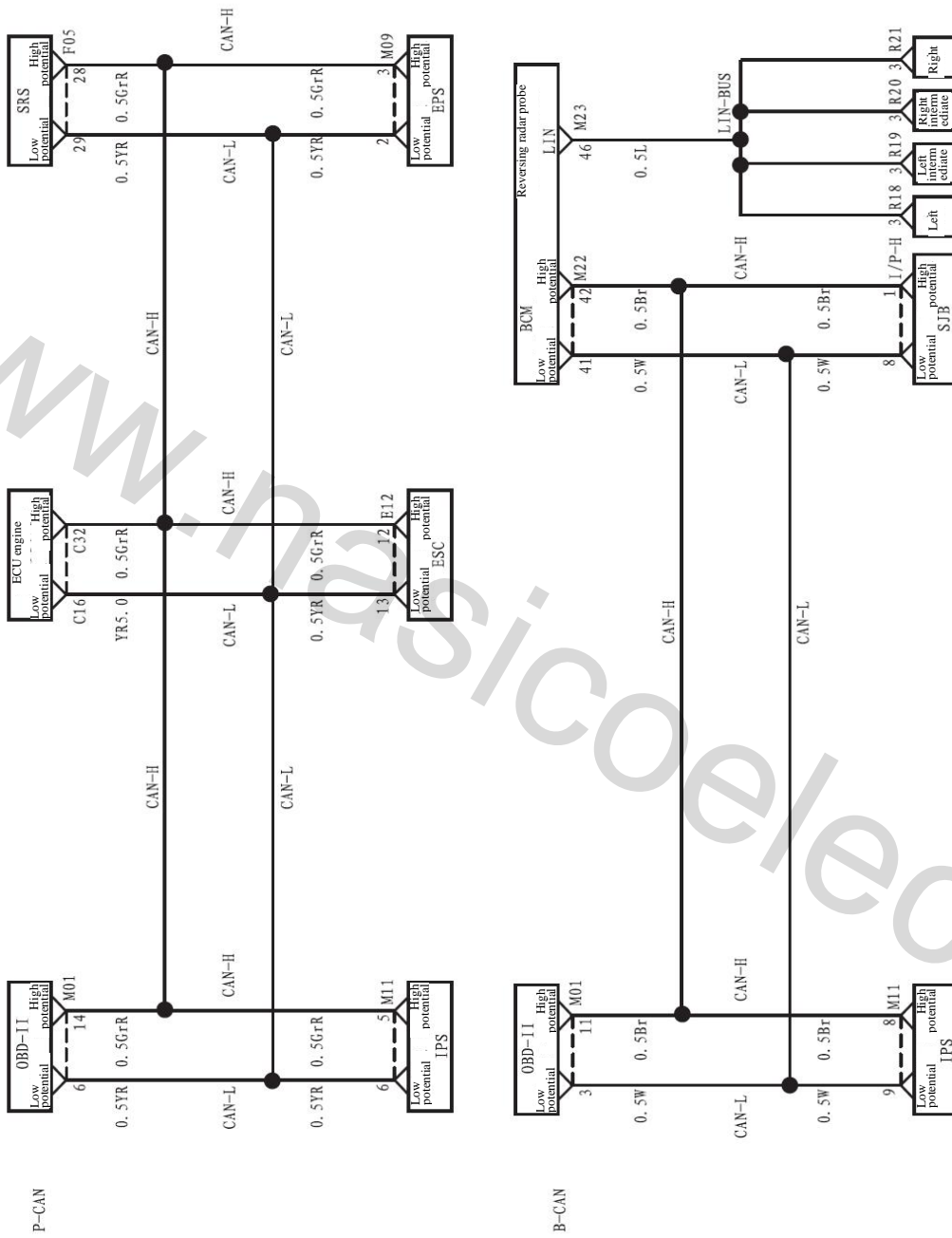

Diagnosis connect with ground wire layout2

M-2

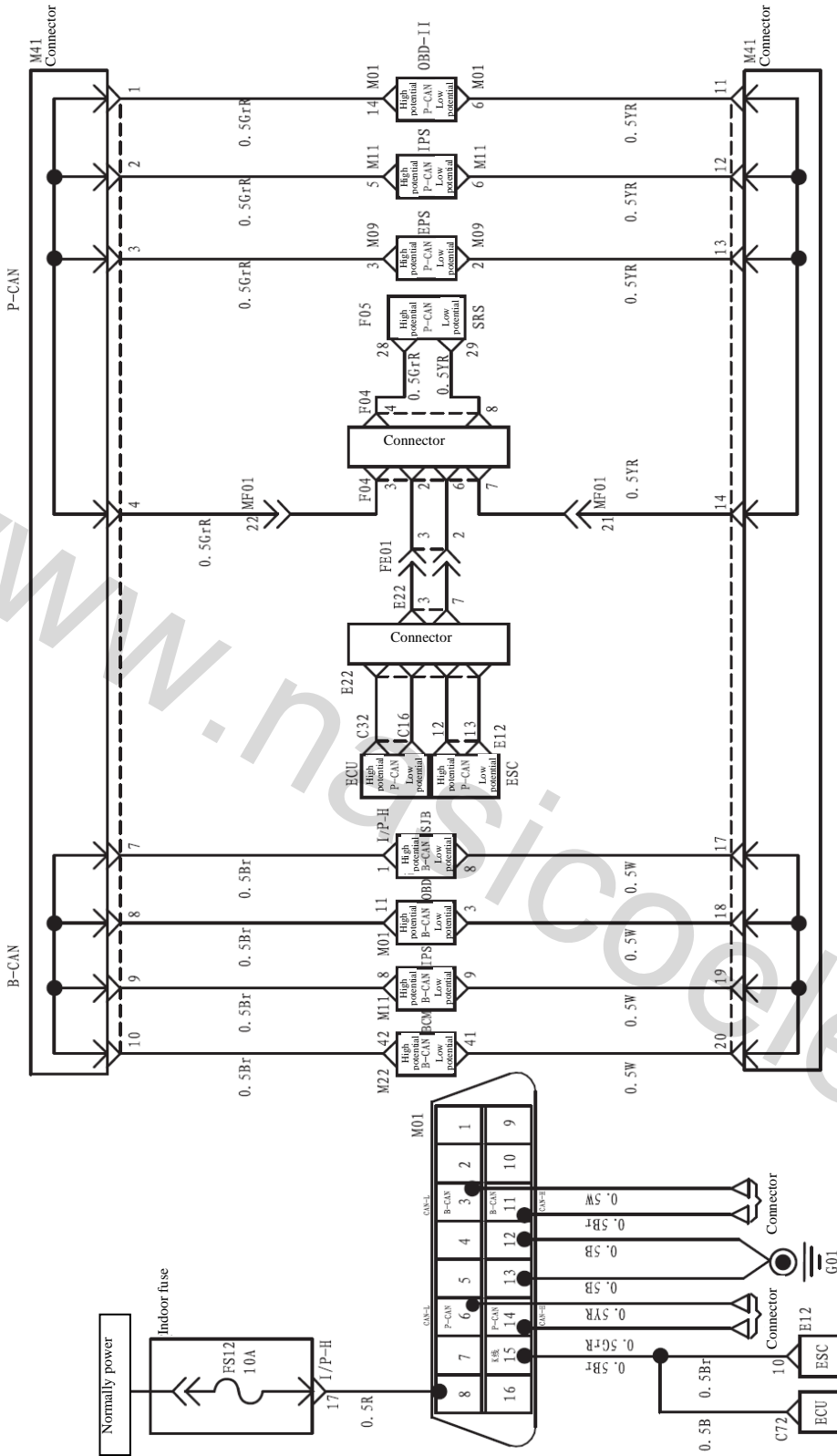

- B-CAN Low speed CAN
- P-CAN High speed CAN
- BCM Control control system
- IPS Combination instrument
- OBD-II Diagnose interface
- EPS Electronic power-assisted steering system
- SRS Airbag controller system
- ESC Electronic stability control system (ABS)
- ECU Engine control system
- SJB Indoor intelligent terminal box
- E22 Electronic power-assisted steering system
- F04 Airbag controller system
- M41 Electronic stability control system (ABS)
- M41 Engine control system
- M41 Indoor intelligent terminal box

Brake lamp, Hand brake lamp, and Fluid level light

N-1

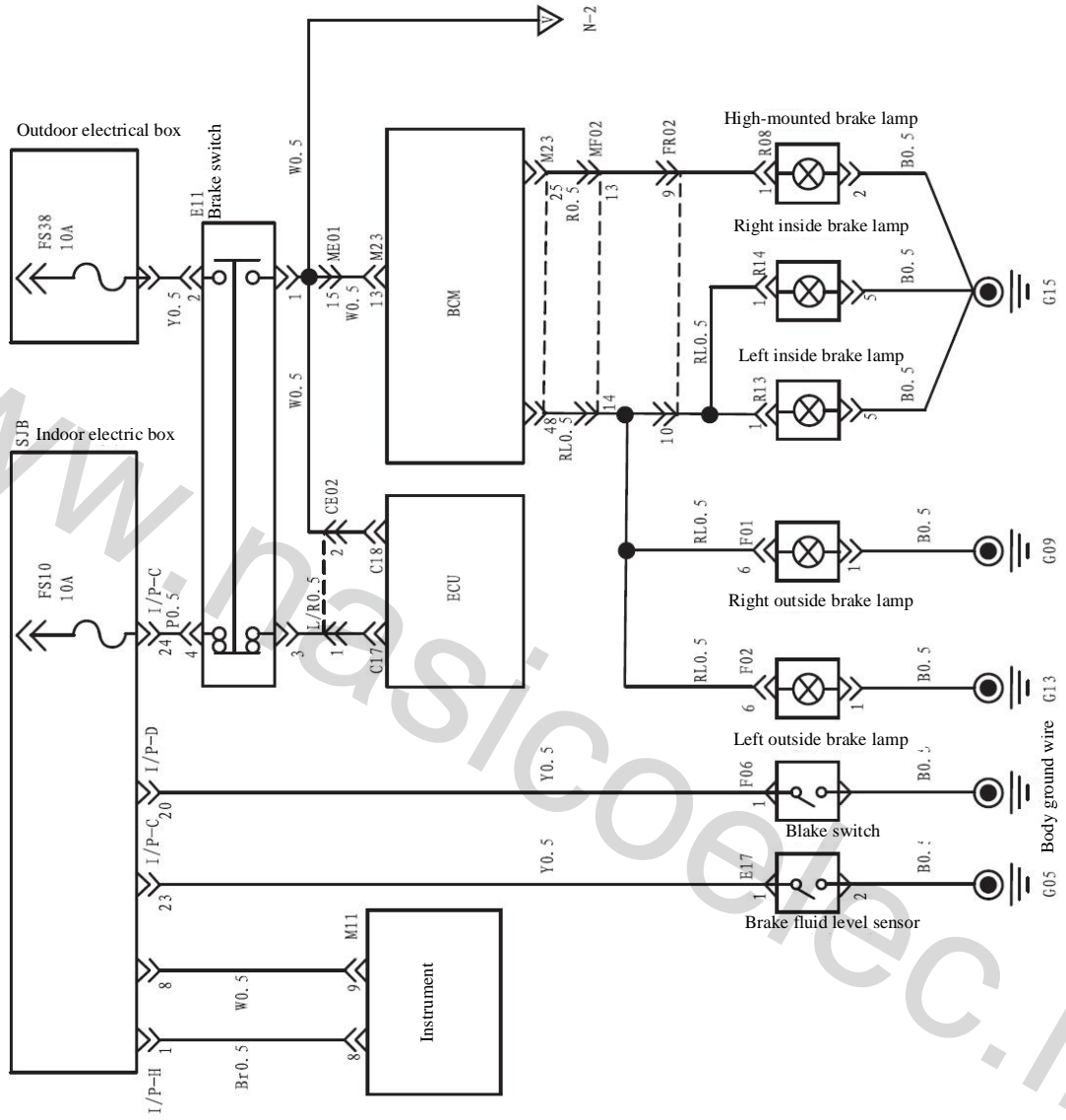

N-2

Anti-lock brake system (ESC)

N-2

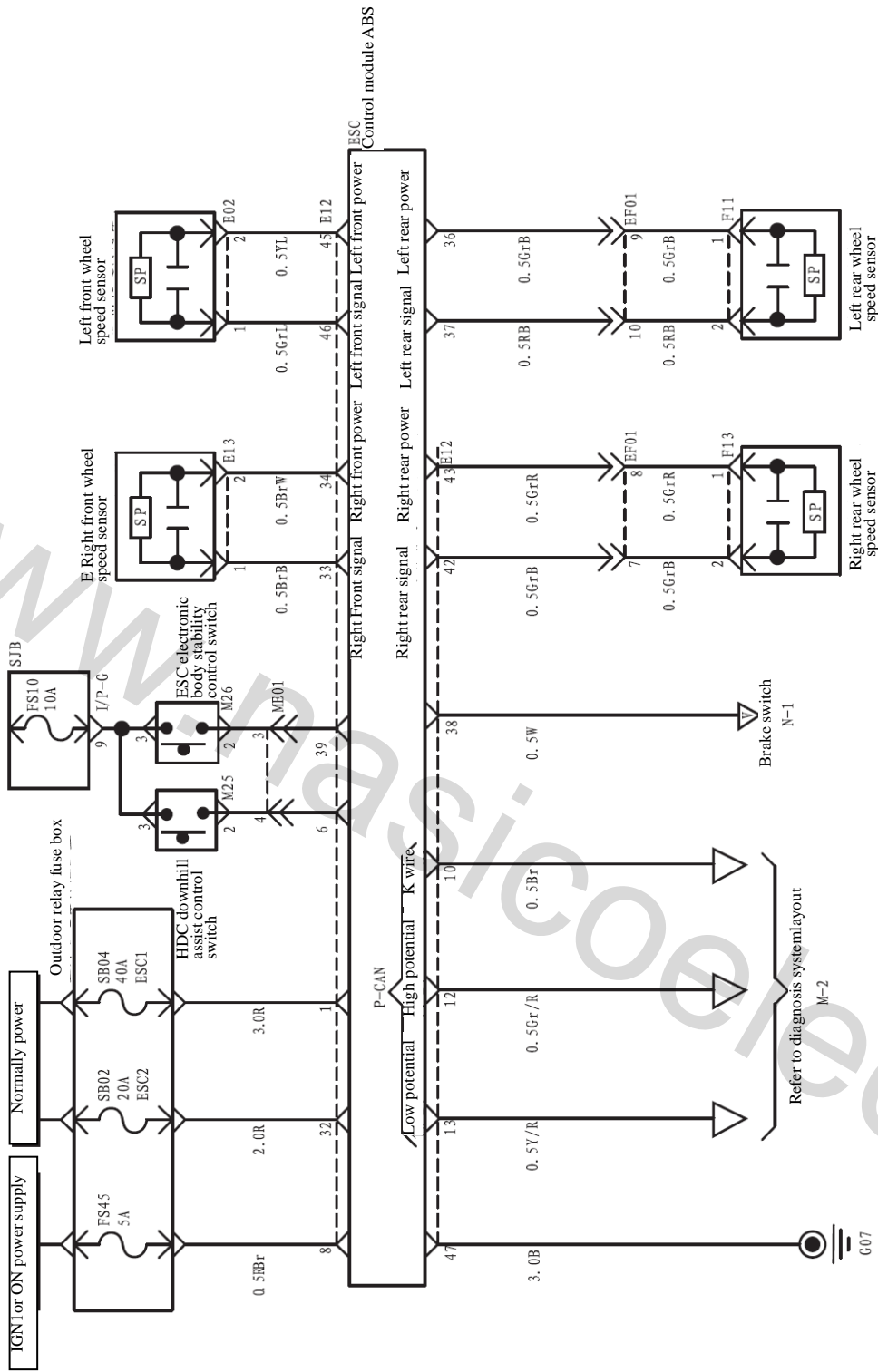

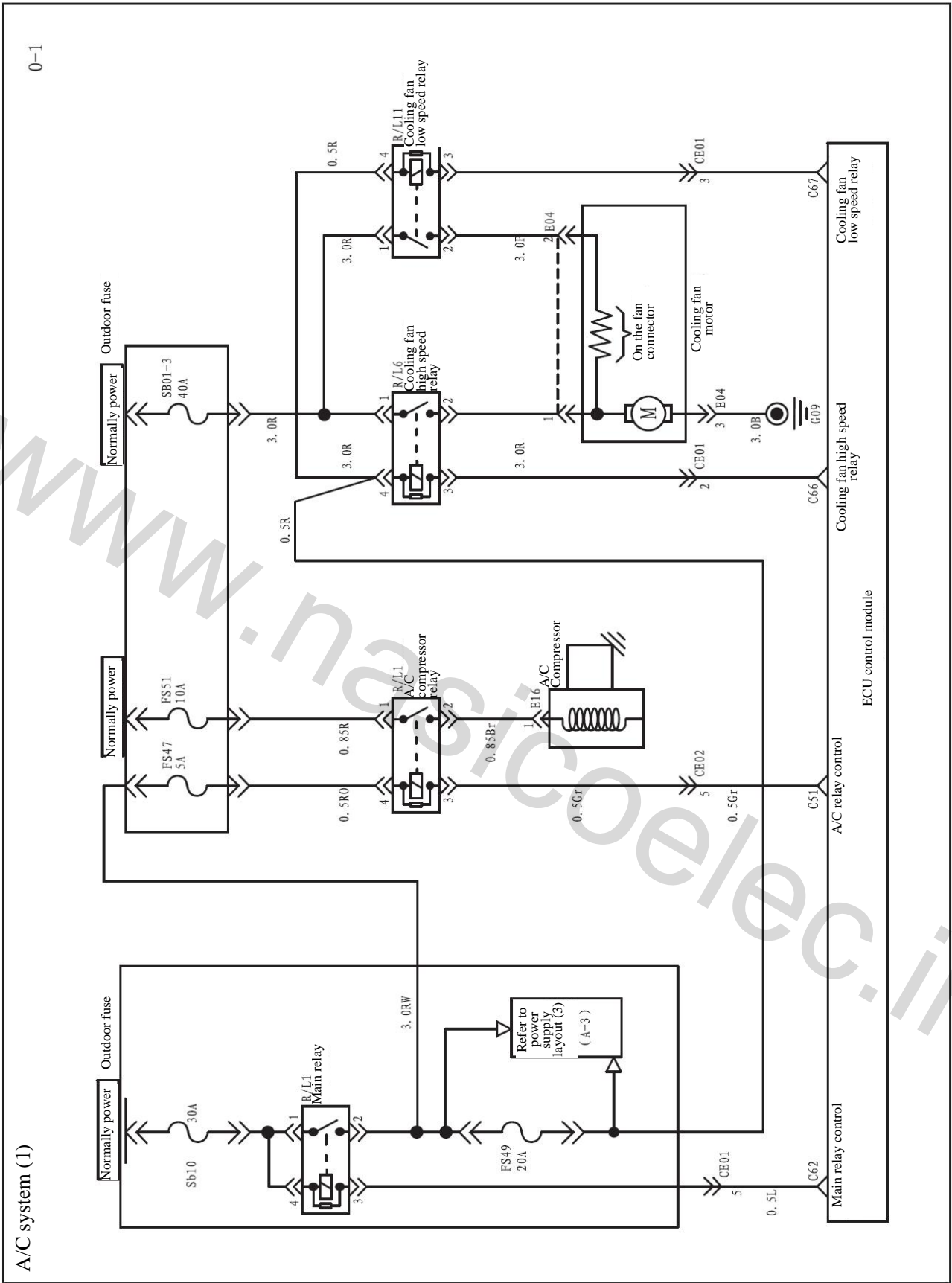

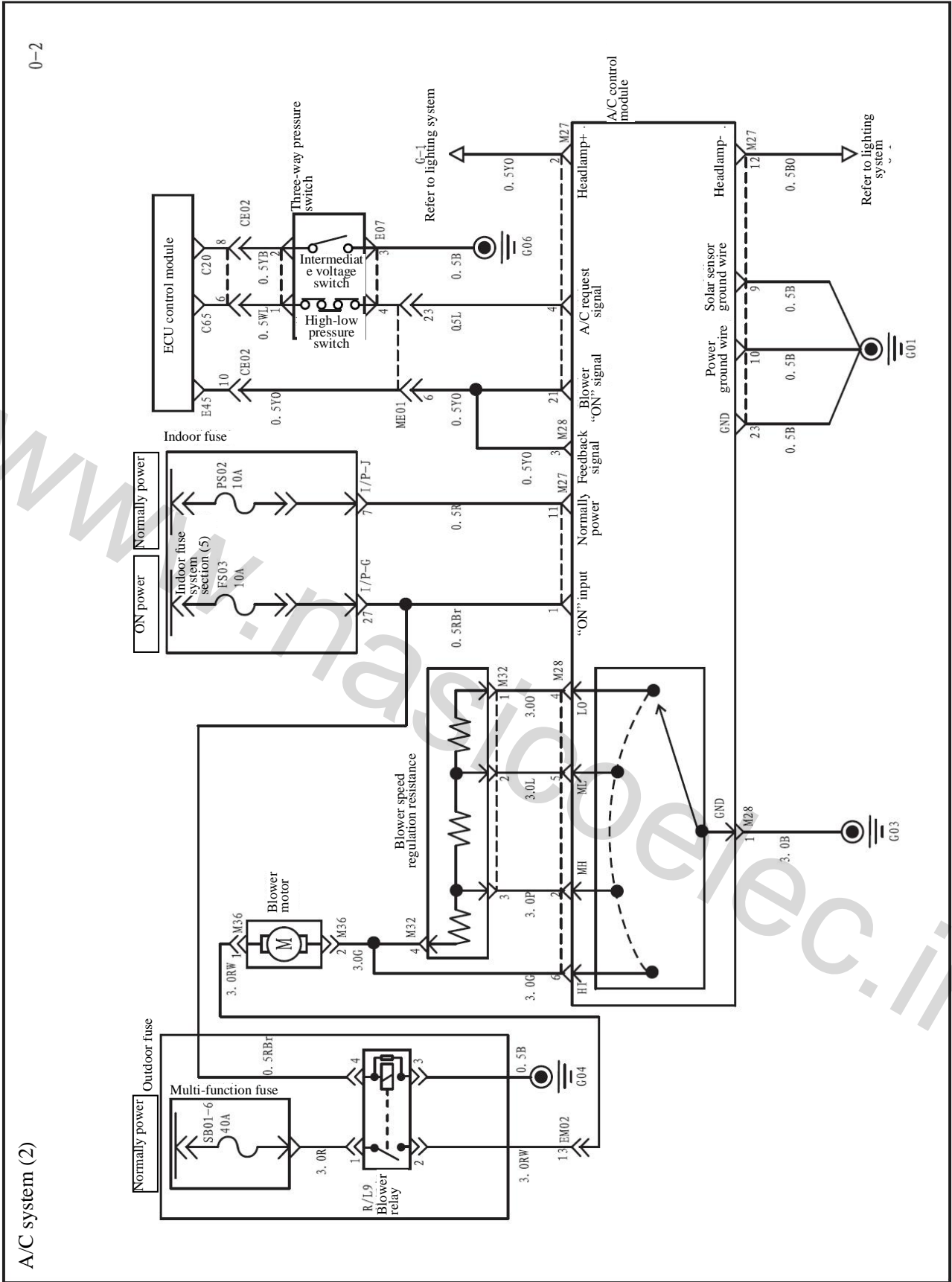

0-3

A/C system (3)

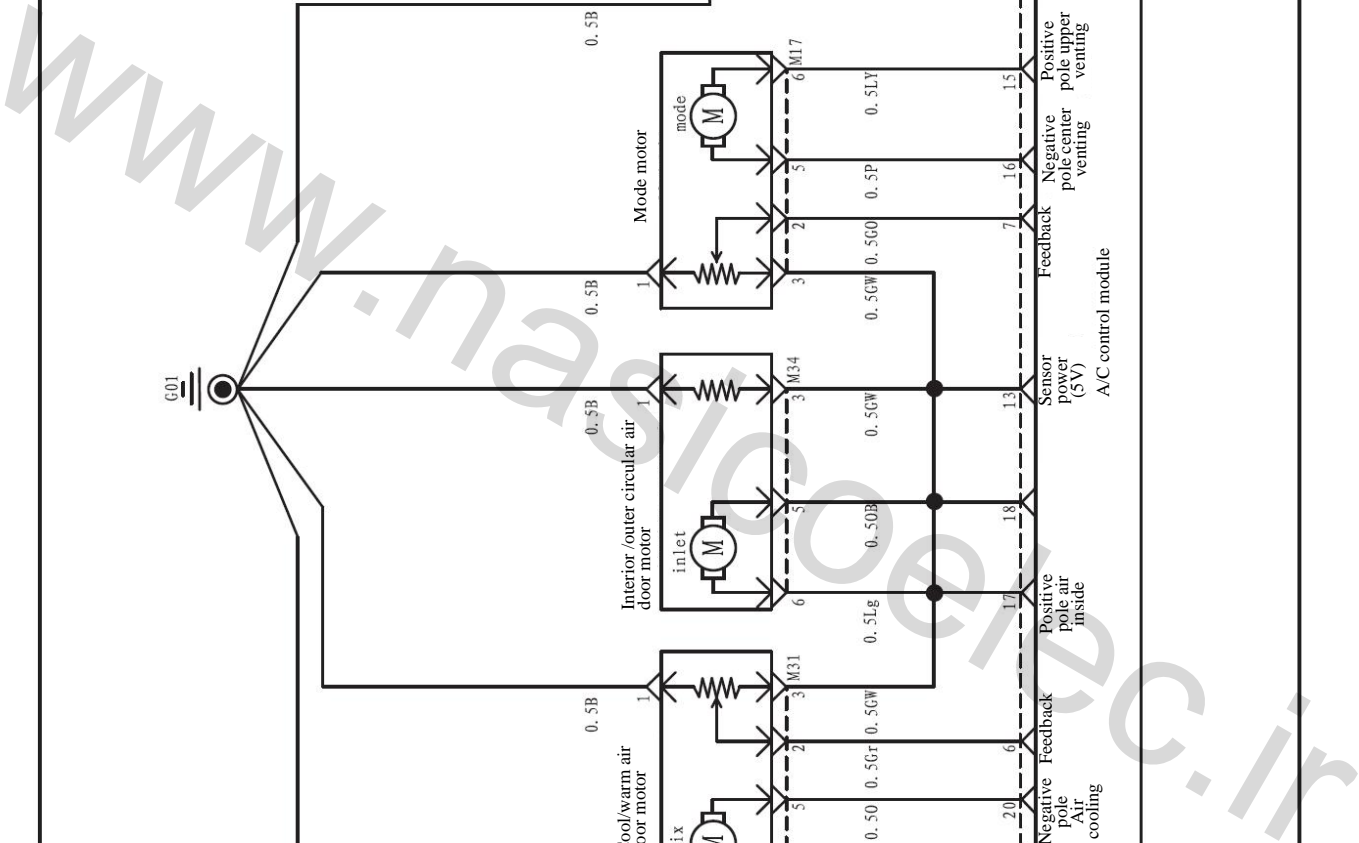
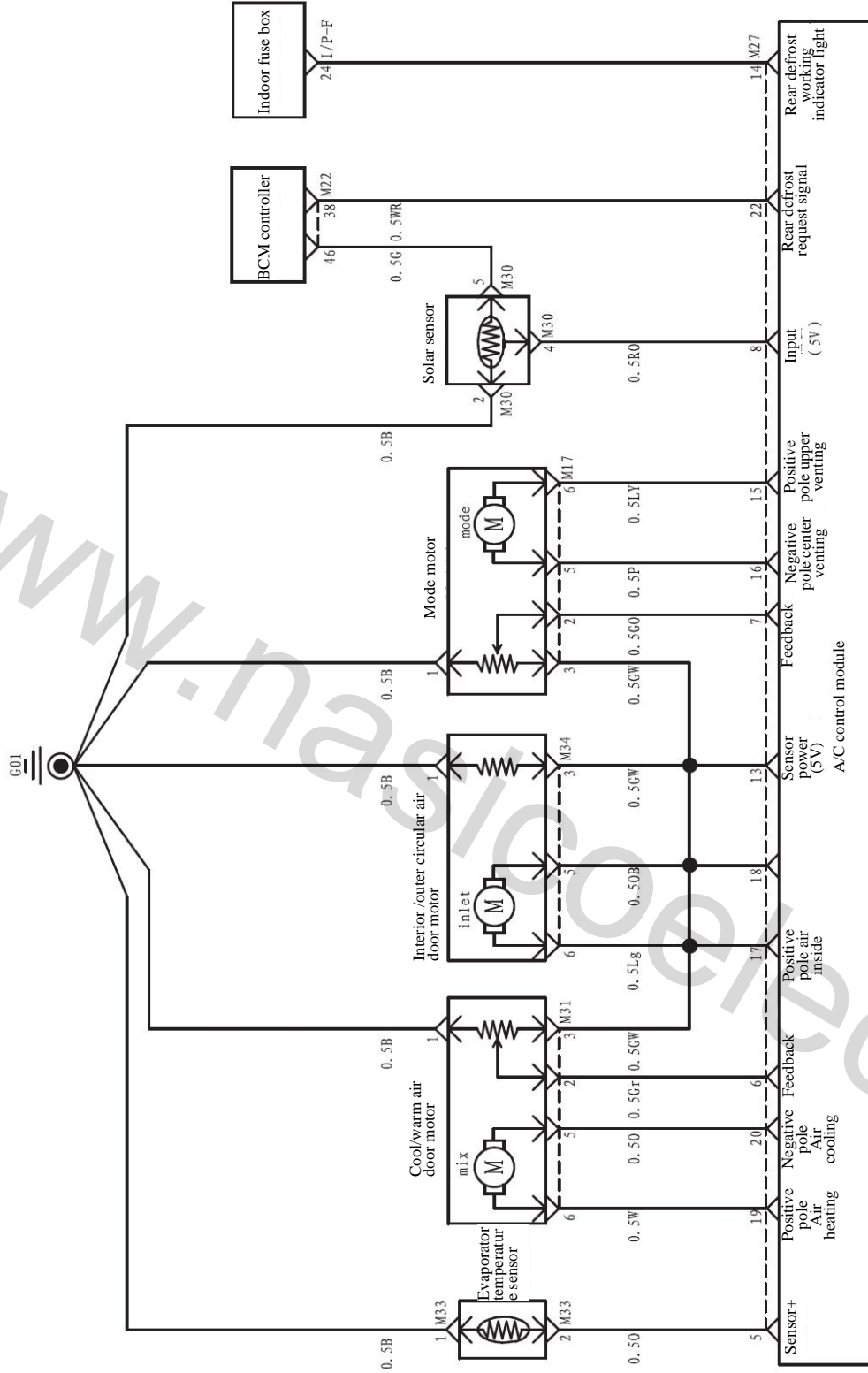

Indicator light and instrument

P-1

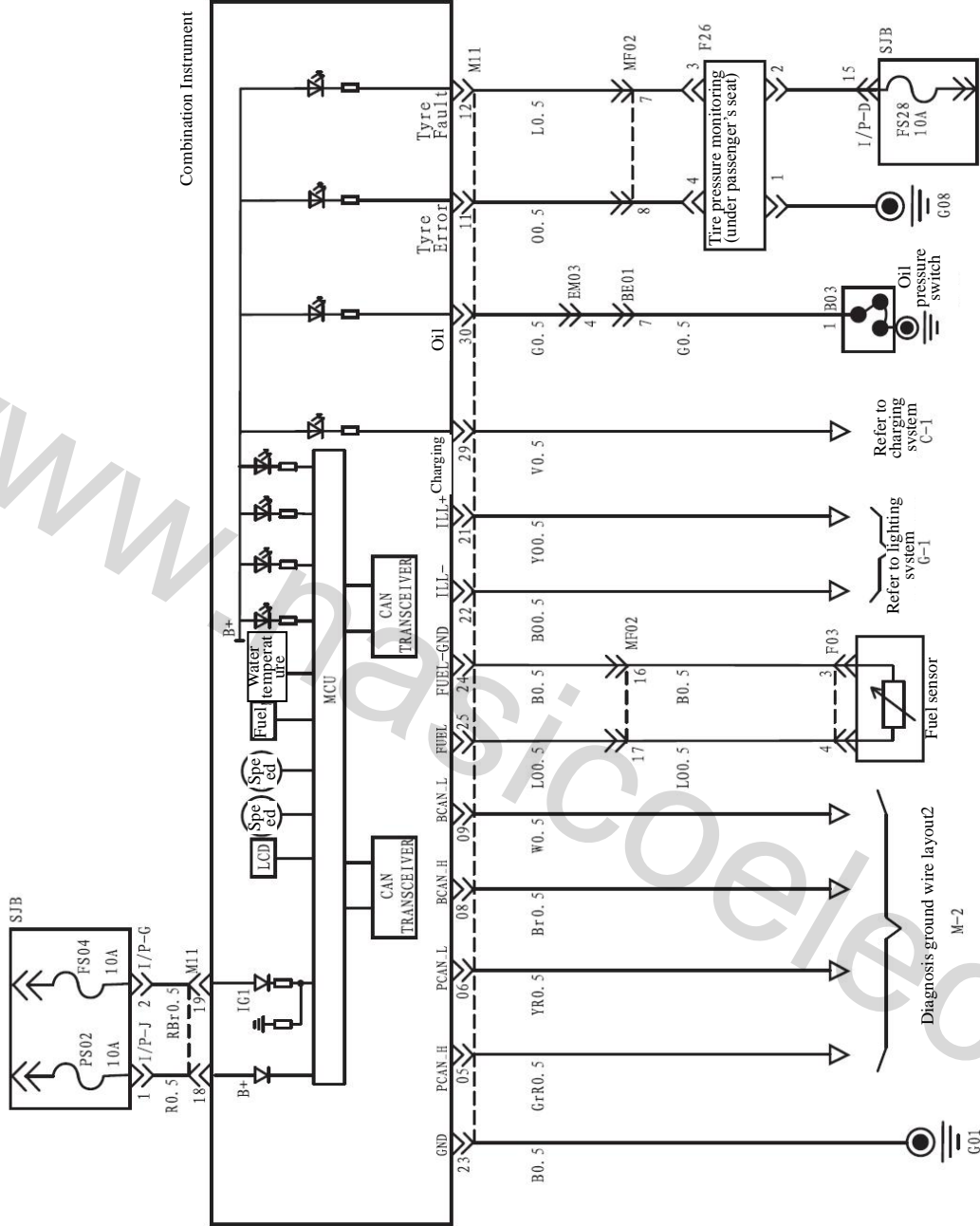

M-2

Fuel sensor

Refer to lighting system G-1

Refer to charging system C-1

Oil pressure switch

Tyre pressure monitoring (under passenger's seat)

Combination Instrument

Q-1

Electric door / window

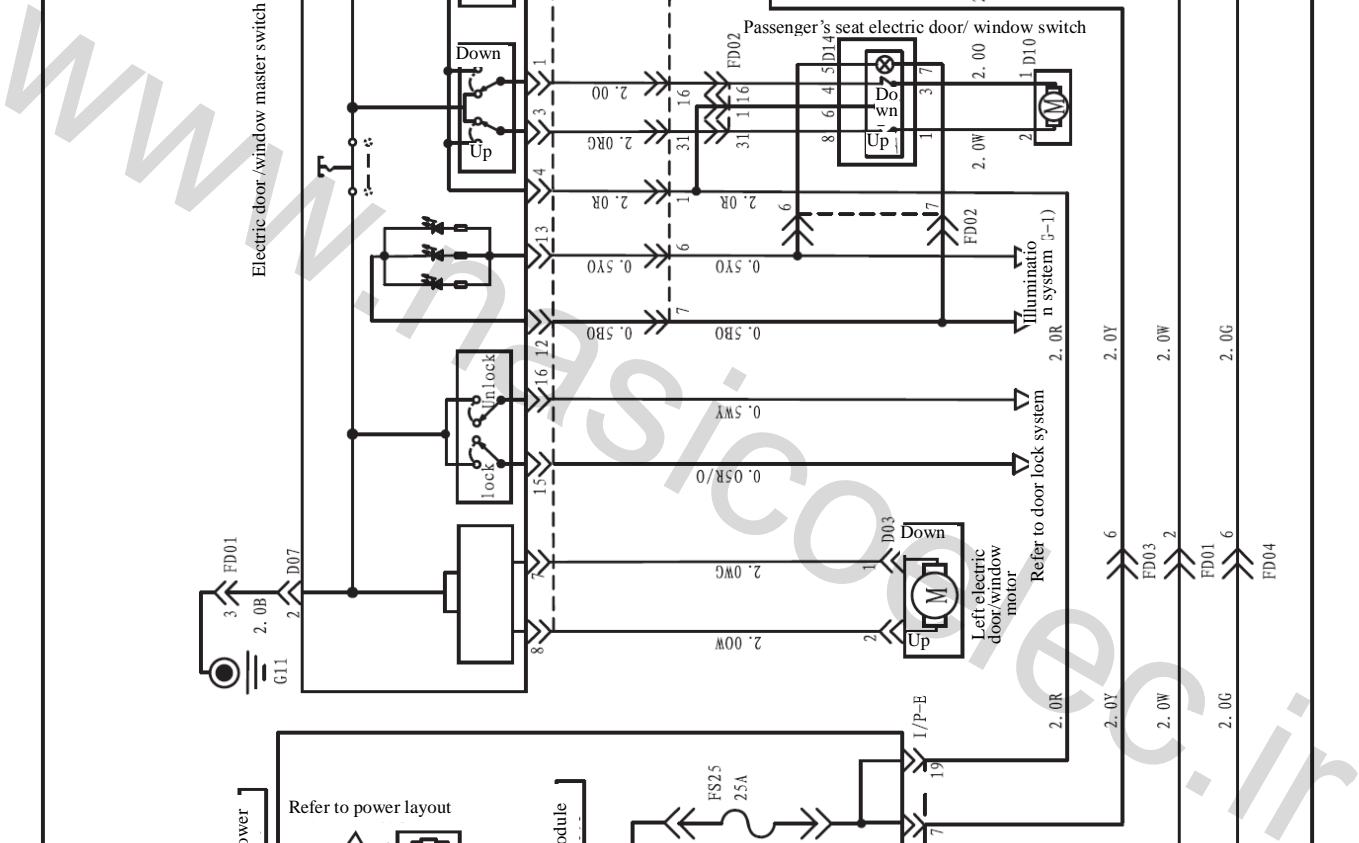
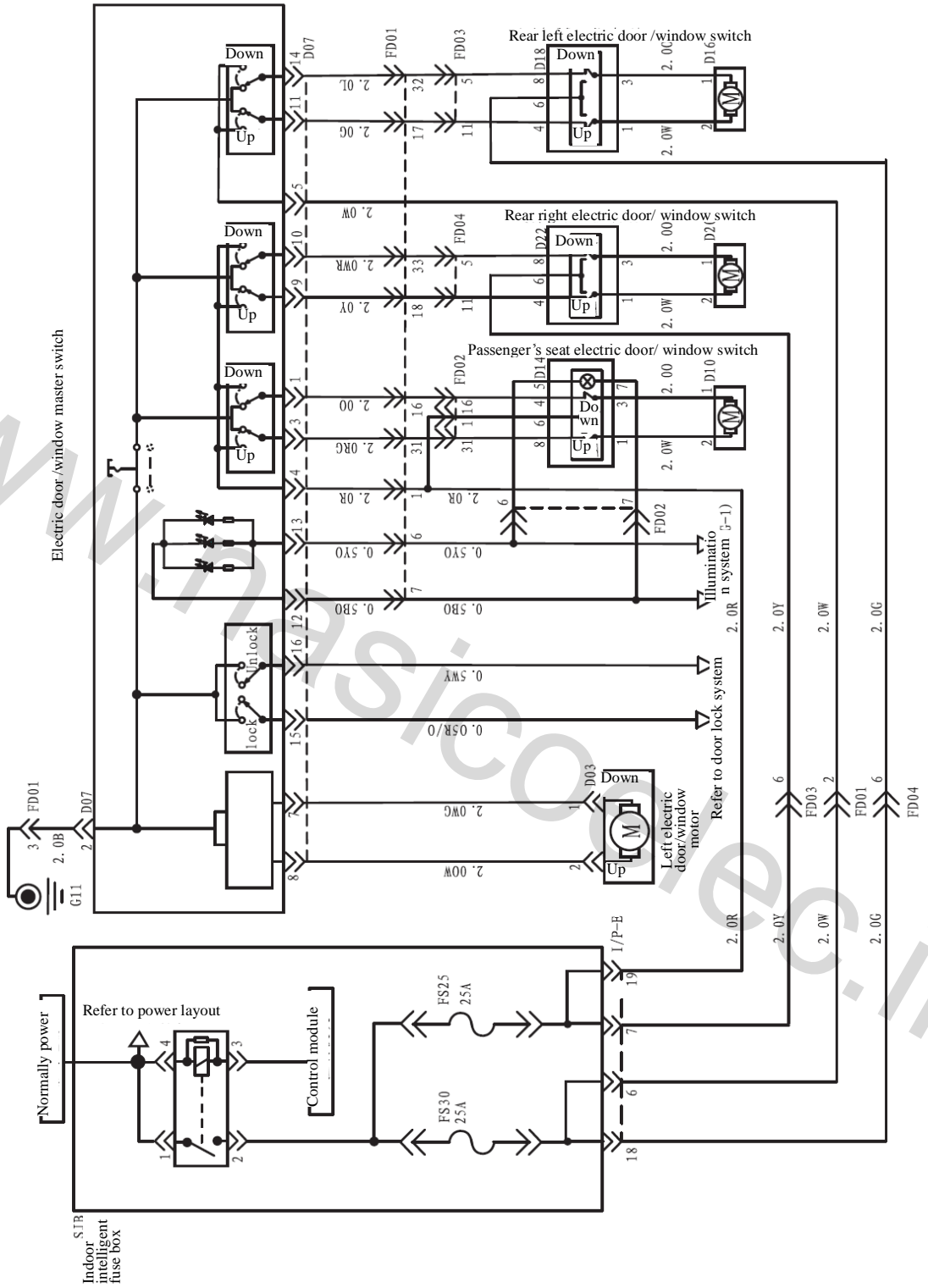

S-1

Doors lock system (1)

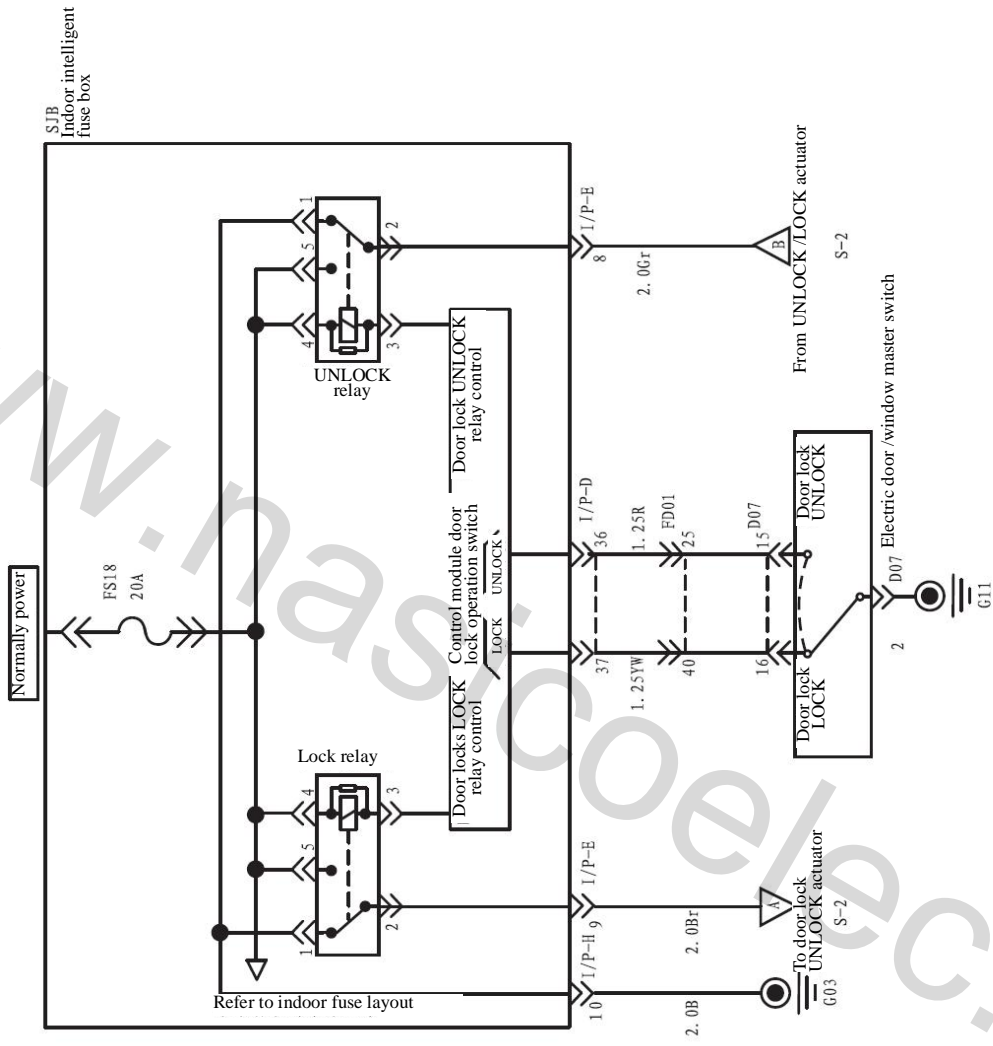

www.nasirco.com

Electric door lock

S-2

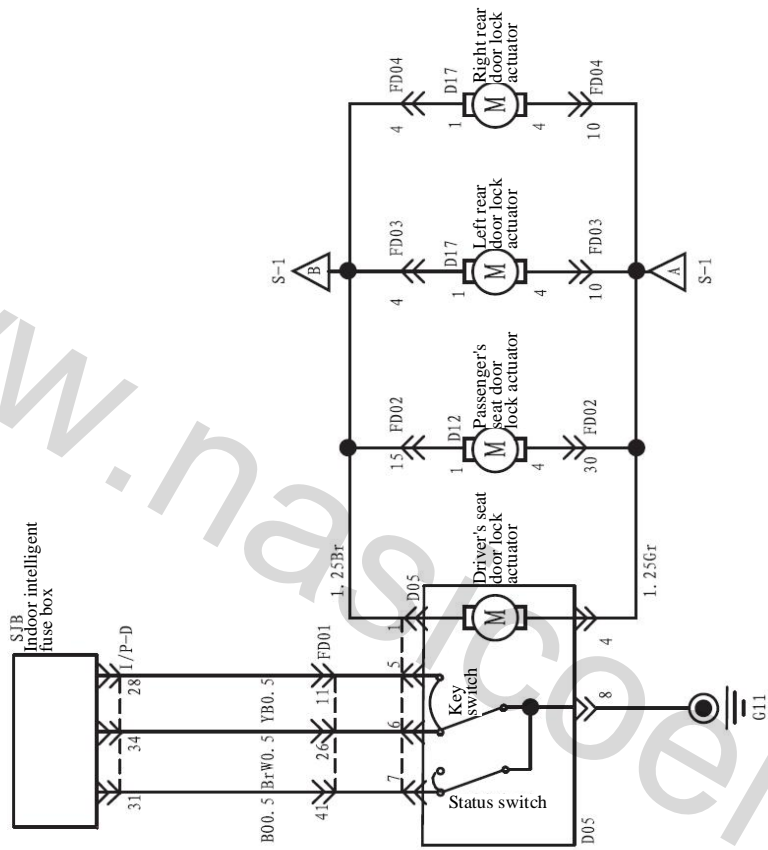

S-3

Remote control and anti-theft alarm system

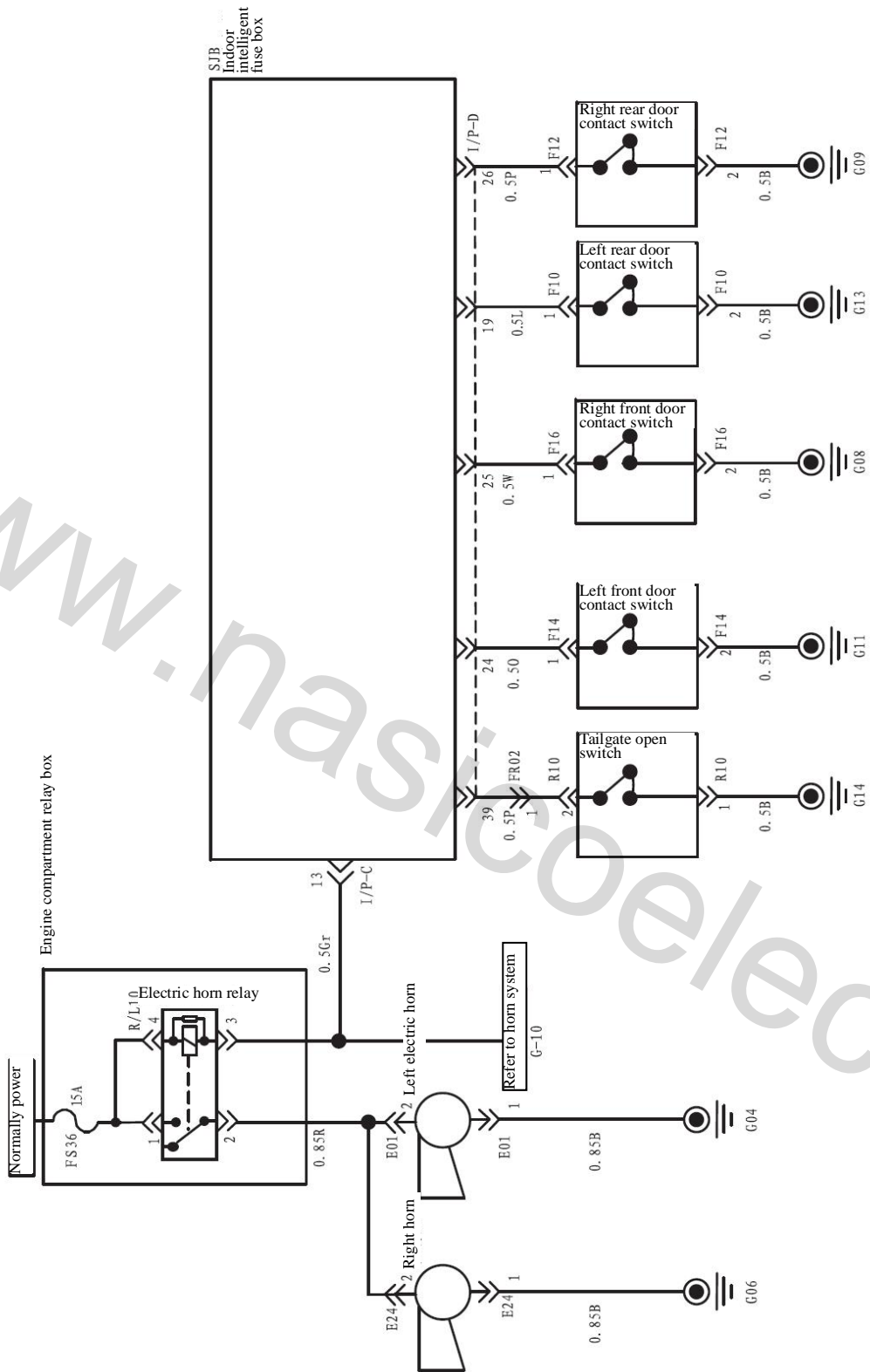

SJB
Indoor
intelligent
fuse box

Engine compartment relay box

Normally power
FS36 15A

R/L
Electric horn relay

2 Right horn
E24

2 Left electric horn
E01

1
Refer to horn system
G-10

0.85B
G06

0.85B
G04

1.3
1/P-C

0.50Gr

39
FR02

0.5P

1
R10

2
G14

0.5B

24
F14

0.50

1
F14

2
G11

0.5B

25
F16

0.5W

1
F16

2
G08

0.5B

19
F10

0.5L

1
F10

2
G13

0.5B

26
F12

0.5P

1
F12

2
G09

0.5B

1/P-D

www.nasircoelec.ir

S-4

Tailgate lock

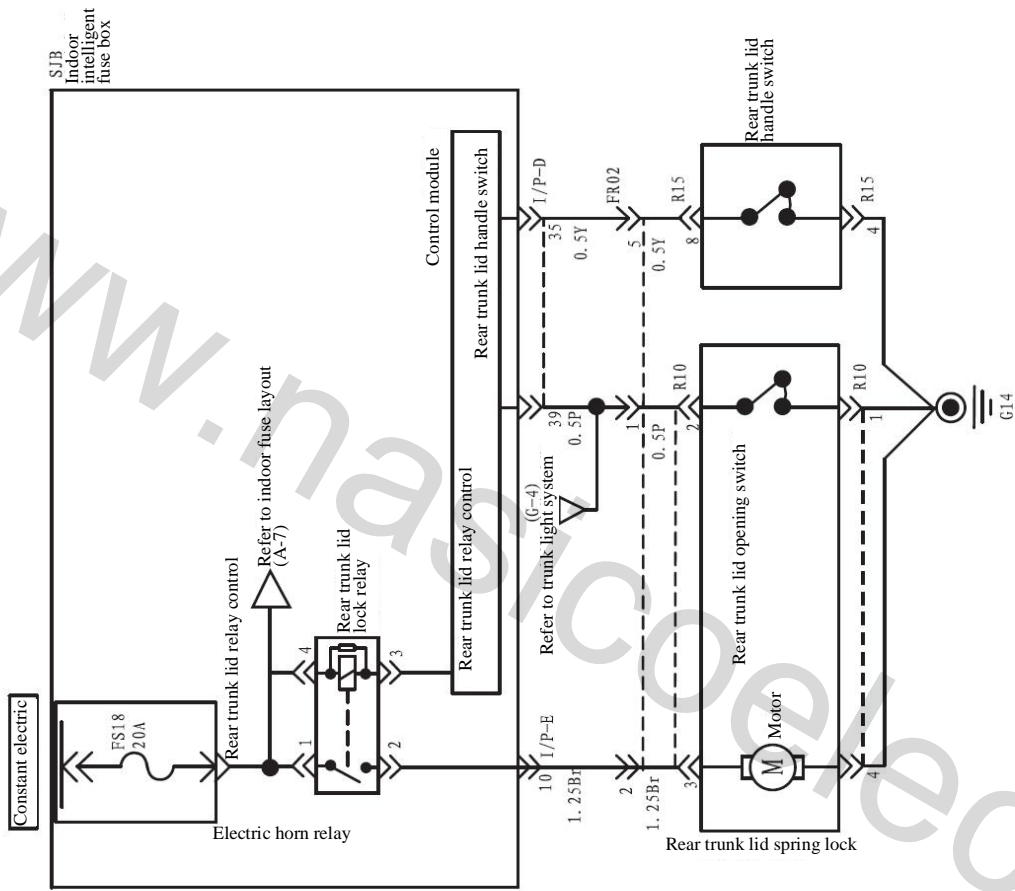

EPS (electric steer pump control)

U-1

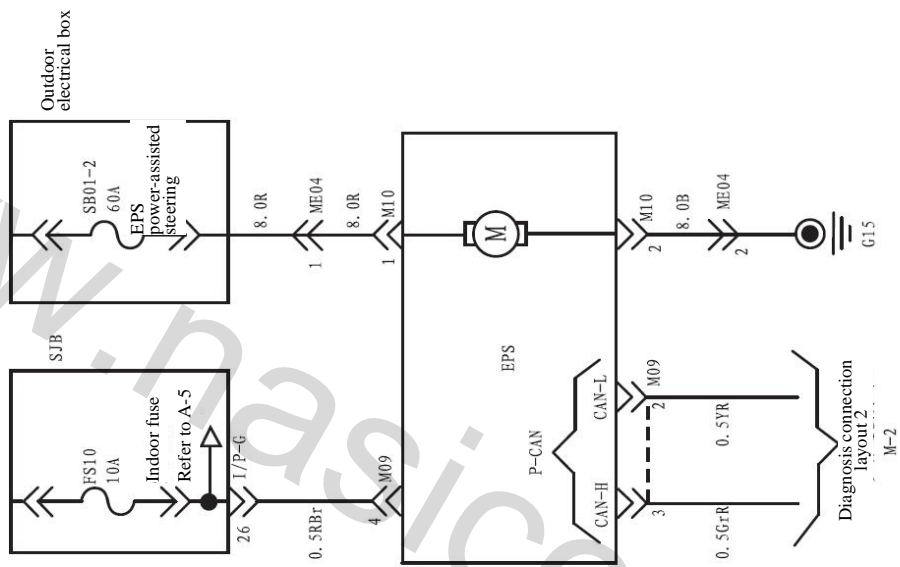

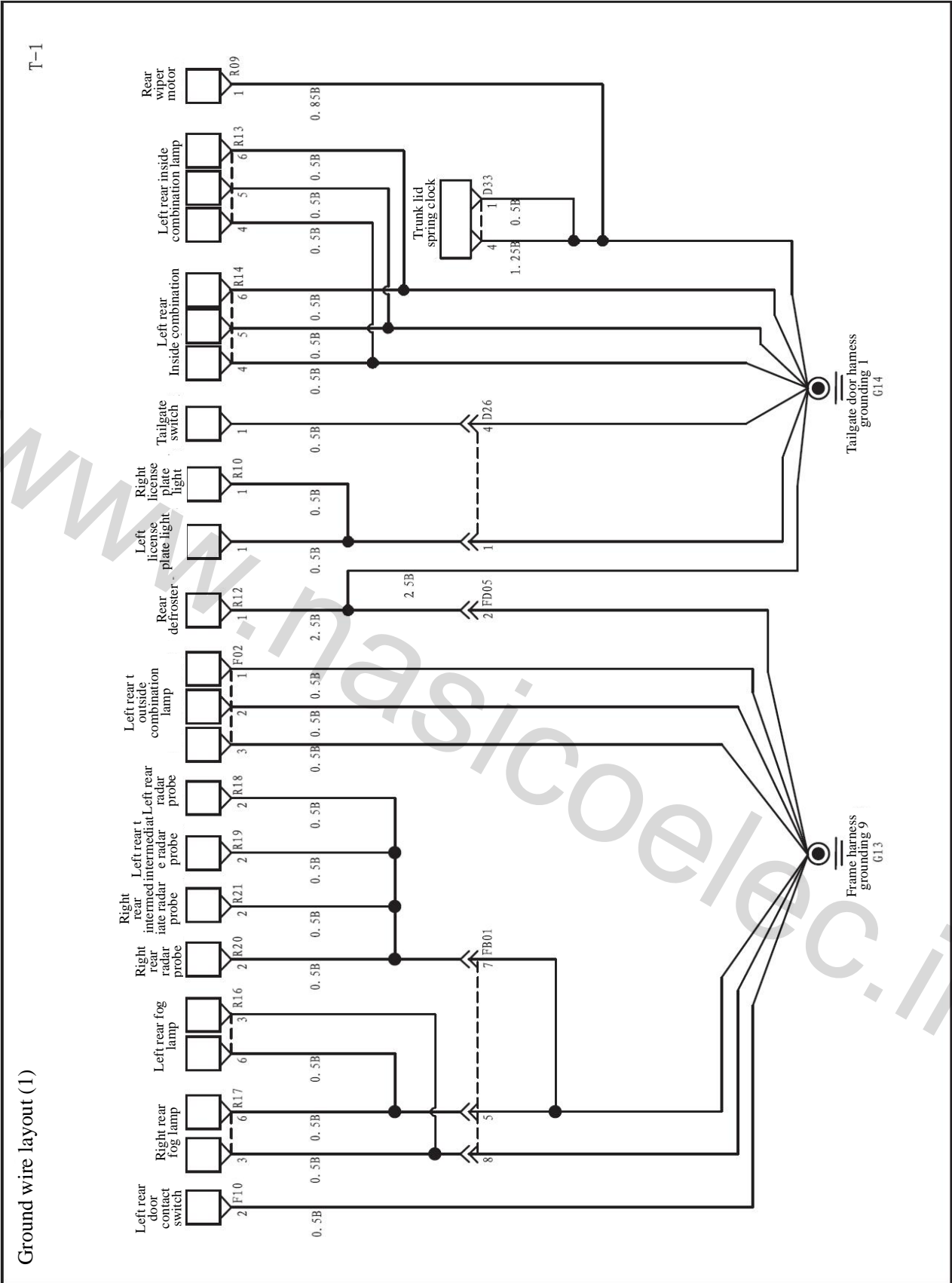

T-1

Ground wire layout (1)

Tailgate door harness
grounding 1
G14

Frame harness
grounding 9
G13

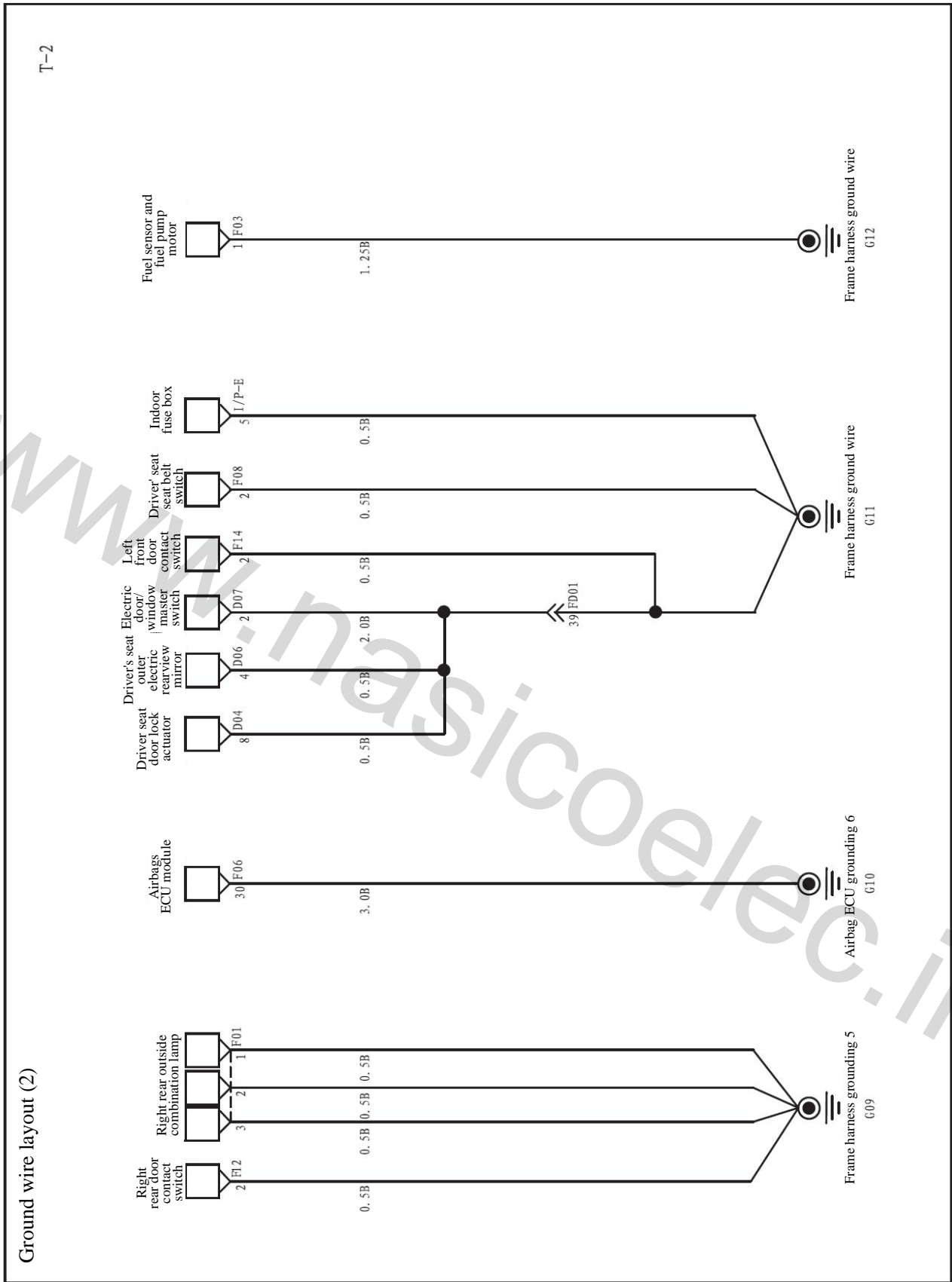

T-3

Ground wire layout (3)

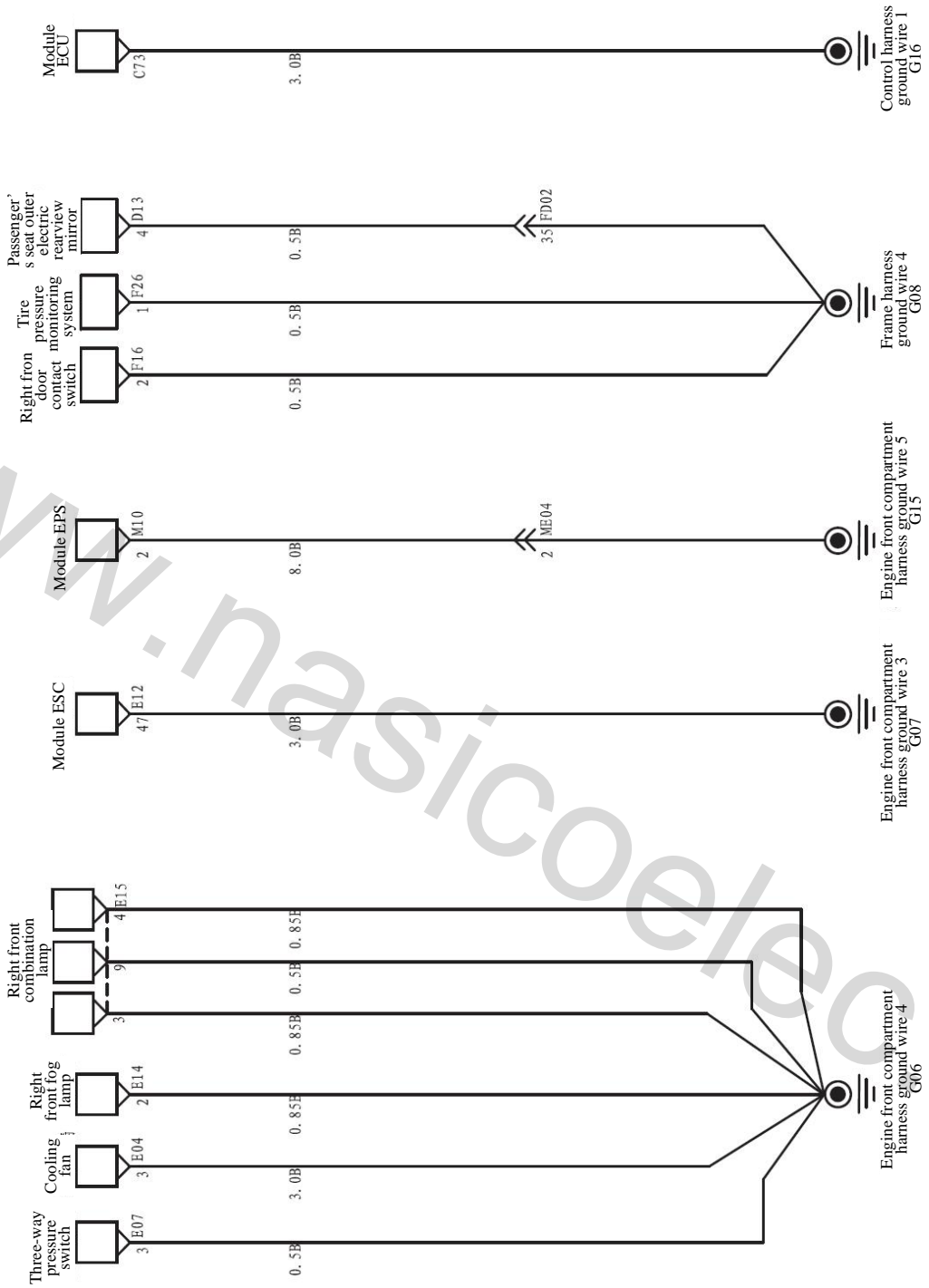

www.nasicoelec.ir

Ground wire layout (4)

T-4

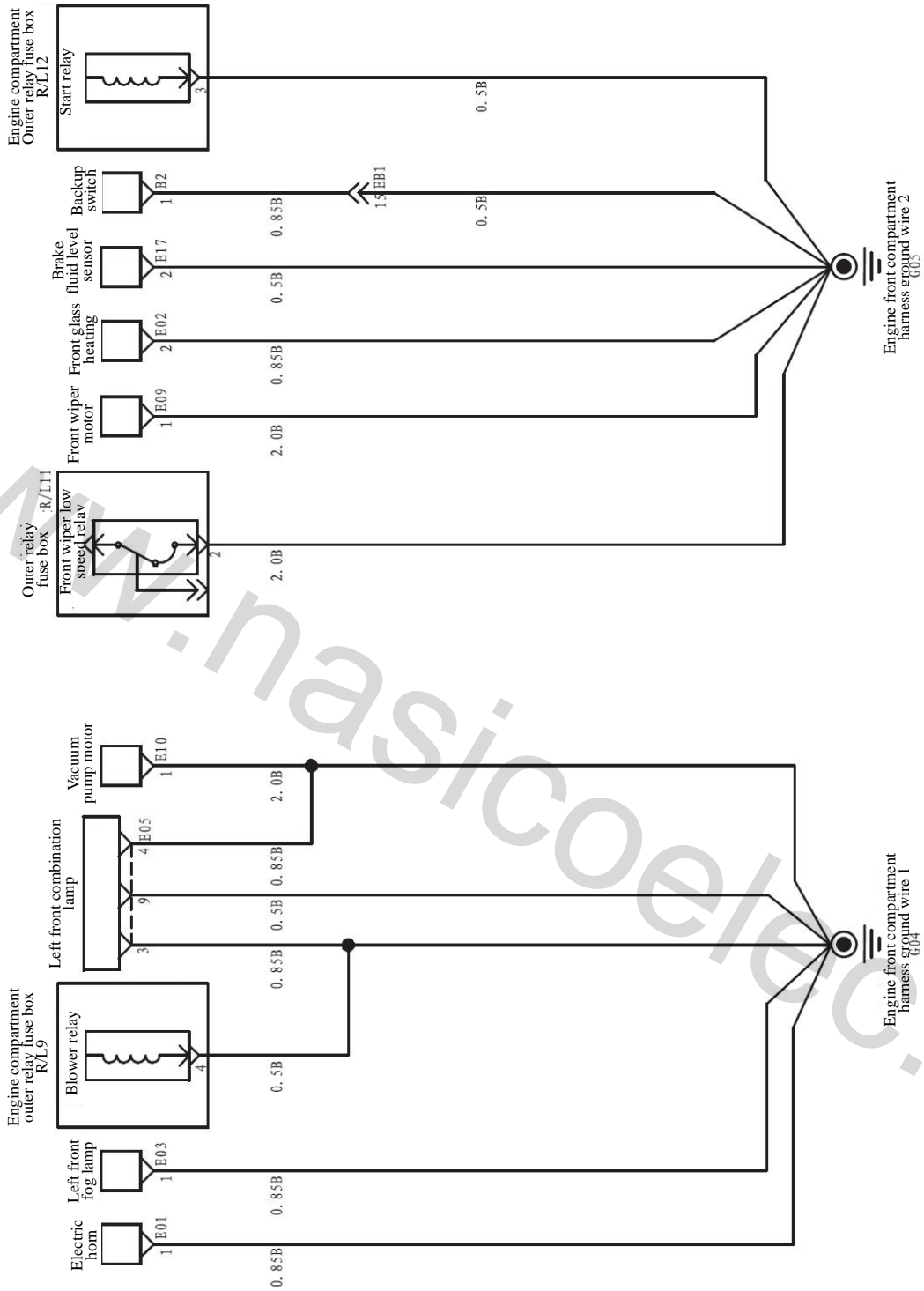

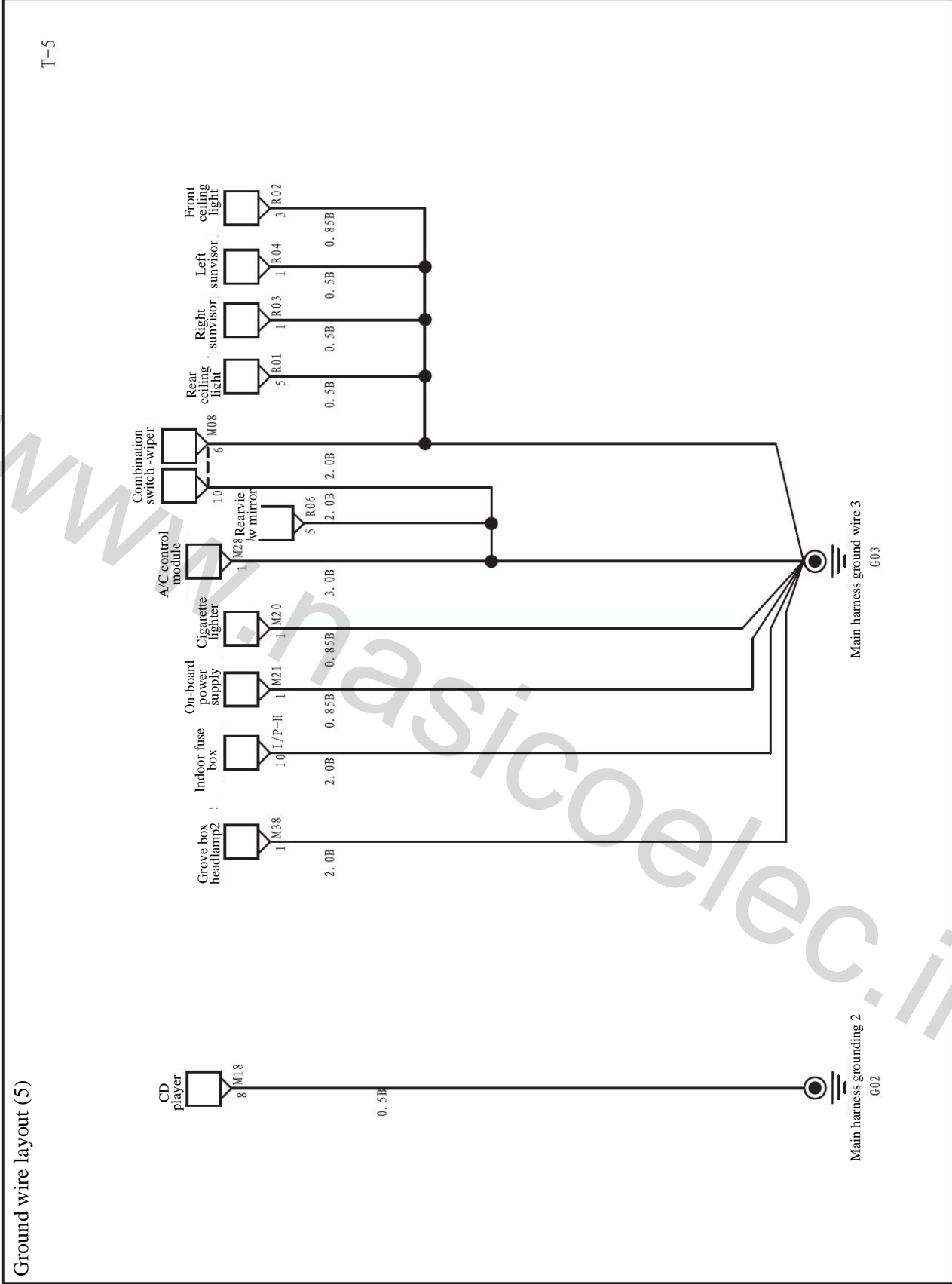

T-5

Main harness grounding 2
G02

Main harness ground wire 3
G03

T-6

Ground wire layout (6)

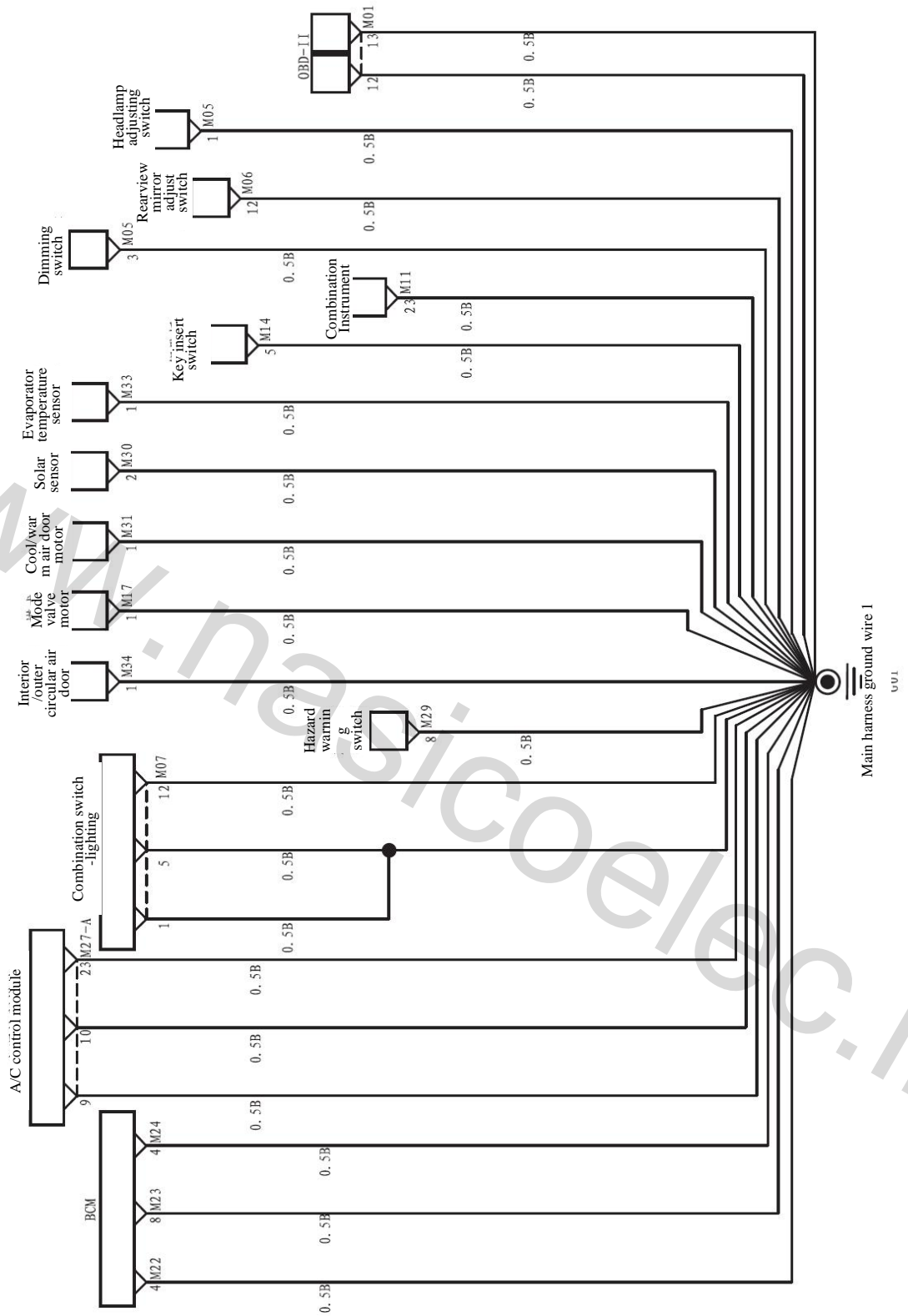

Main harness ground wire 1

v.u.l

Connector content

Main wire harness connector	CC-2
Engine wire harness connector	CC-17
Frame wire harness connector	CC-25
Ceiling wire harness connector	CC-30
Tailgate wire harness connector	CC-32
Reversing radar wire harness connector	CC-35
Left front door wire harness connector	CC-37
Right front door wire harness connector	CC-40
Back door glass wire harness connector	CC-43
Power wire harness connector	CC-45
Wire harness connector	CC-48
Indoor terminal box connector	CC-63
Control wire harness connector	CC-72

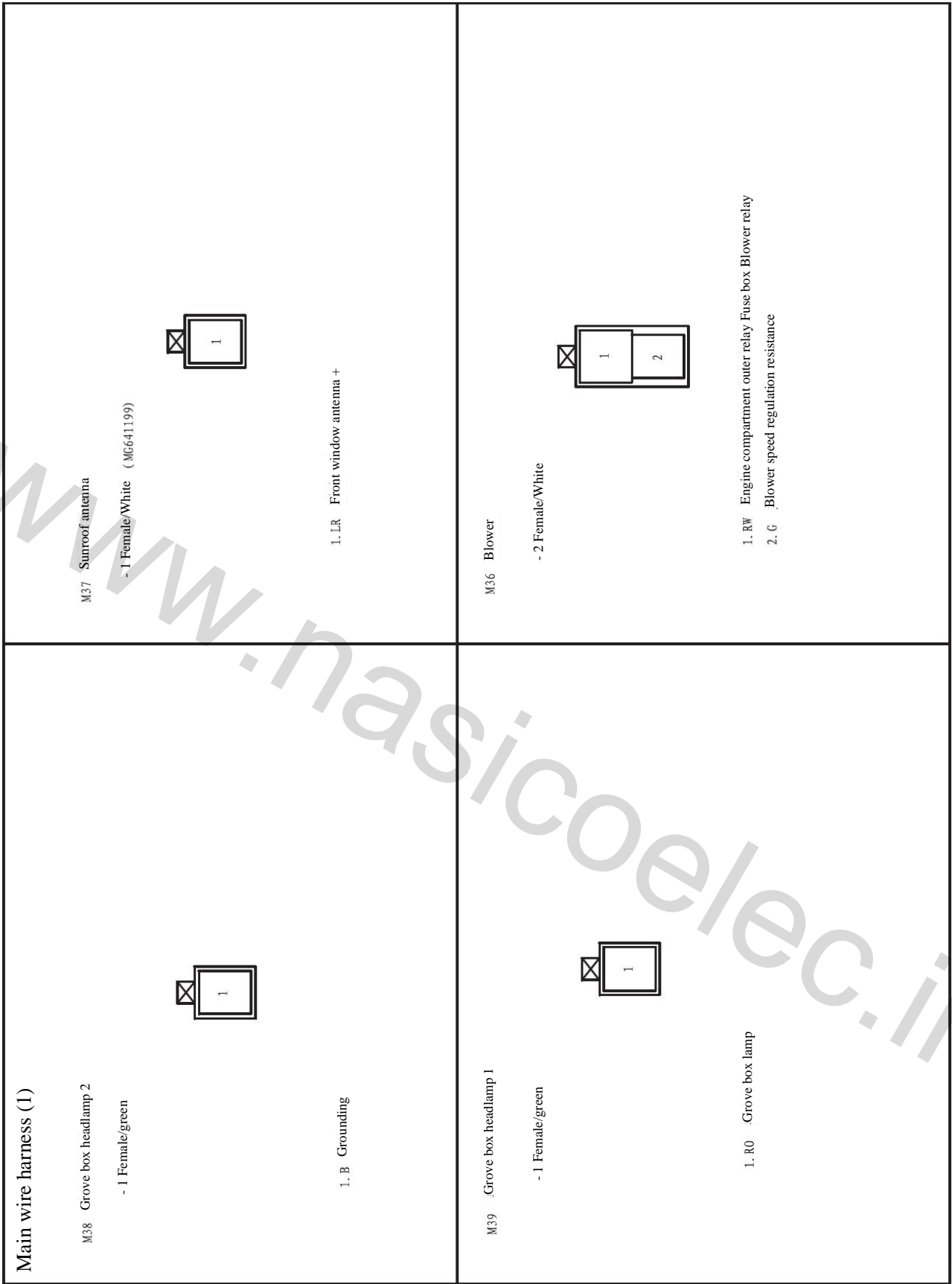

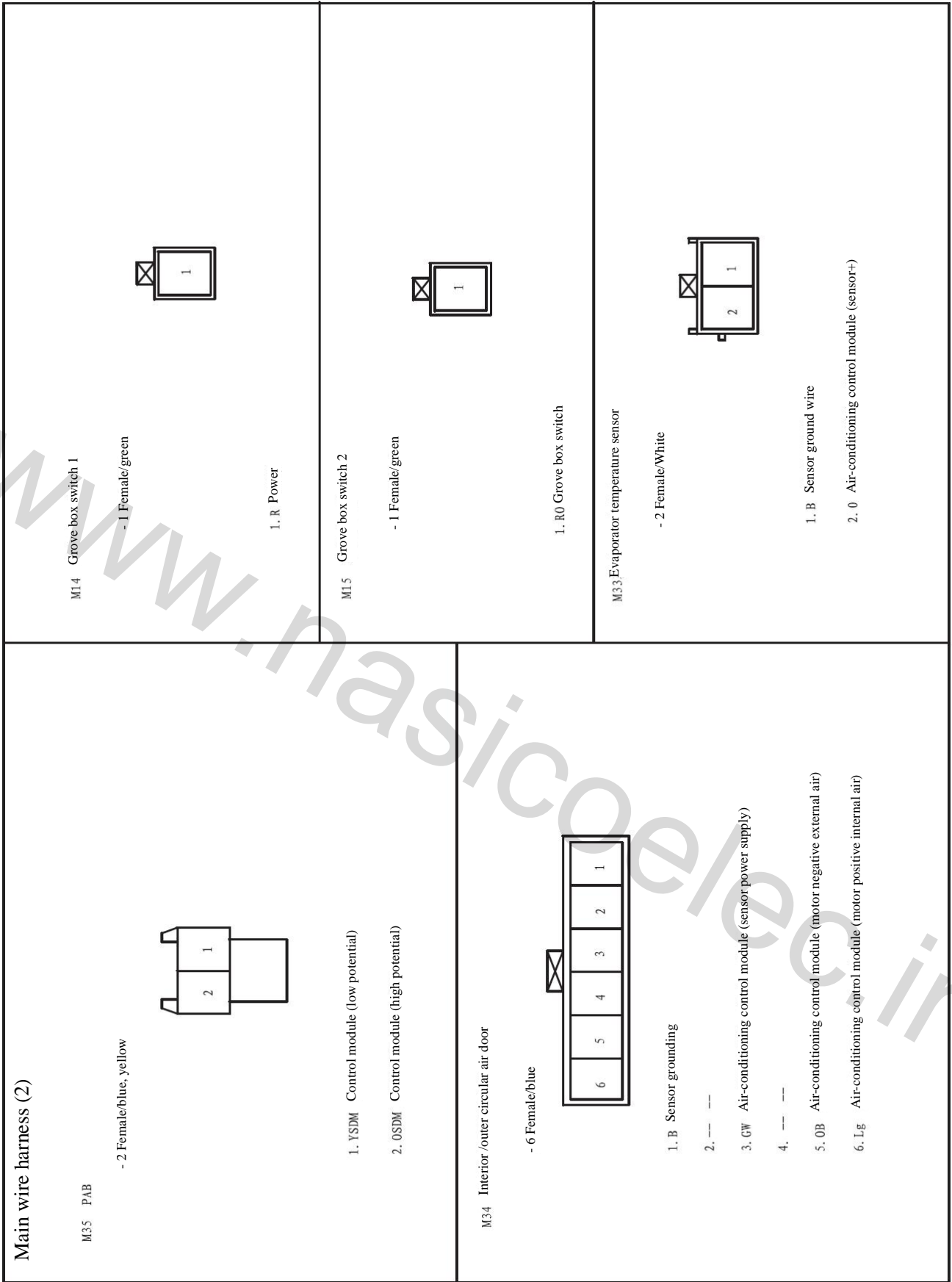

Main wire harness (3)

M30 Solar sensor

- 6 Female/White

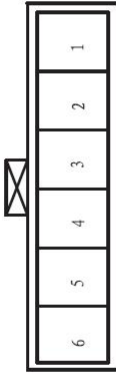

- 1. --- ---
- 2. B Sensor grounding
- 3. -----
- 4. R0 Air-conditioning control module (power supply)
- 5. G Low level light signal output
- 6. -----

M32 Blower speed regulation resistance

- 4 Female/White



- 1. 0 1 Gear wind speed
- 2. L 2 Gear wind speed
- 3. P 3 Gear wind speed
- 4. G 4 Gear wind speed

M31 Cool/warm air door motor

- 6 Female/blue

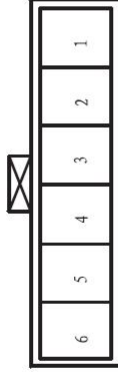

- 1. B Sensor grounding
- 2. Gr Air-conditioning control module (feedback)
- 3. CW Air-conditioning control module (sensor power supply)
- 4. --- ---
- 5. 0 Air-conditioning control module (motor negative cool air)
- 6. W Air-conditioning control module (motor positive warm air)

Main wire harness (4)

M27 Air-conditioning controller A

- 23 Female White (MG651563)

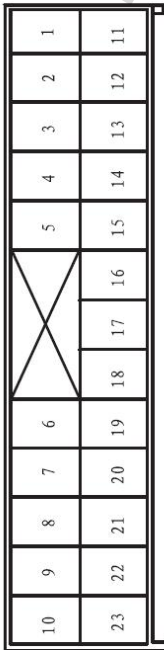

- 16. P Mode valve motor negative pole
- 17. Lg Recalculated/outside air door motor negative terminal
- 18. 0B Recalculated/outside air door motor positive terminal
- 19. W Cool/warm air door motor positive terminal
- 20. 0 Cool/warm air door motor negative terminal
- 21. Y0 Blower request signal
- 22. WR Rear defrost request signal
- 23. B Signal ground wire of complete vehicle

- 1. RBr ON power
- 2. Y0 Backlight +
- 3. --- ---
- 4. L A/C request signal
- 5. 0 Evaporator temperature sensor (power supply)
- 6. Gr Cool/warm air door motor (feedback)
- 7. G0 Mode air door motor (feedback)
- 8. R0 Solar sensor (power supply)
- 9. B Solar sensor ground wire
- 10. B Power ground wire of complete vehicle
- 11. R B+
- 12. B0 Backlight -
- 13. GW 5V voltage output
- 14. Y Rear defrost feedback signal
- 15. LY Mode valve motor positive pole

Main wire harness (5)

M28 A/C controller B

- 6 Female/black

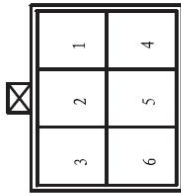

- 1. B Grounding
- 2. P 3 Gear wind speed
- 3. Y 0 blower status
- 4. 0 1 Gear wind speed
- 5. L 2 Gear wind speed
- 6. G 4 Gear wind speed

M29 Hazard alarm switch

- 10 Female/White

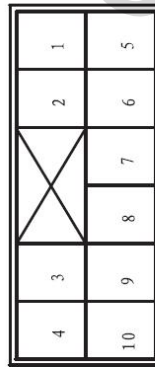

- 1. ---
- 2. Y0 Backlight +
- 3. B0 Backlight -
- 4. ---
- 5. ---
- 6. ---
- 7. G Hazard warning light signal
- 8. B Grounding
- 9. ---
- 10. ---

M26 ESC

- 6 Female/light grey

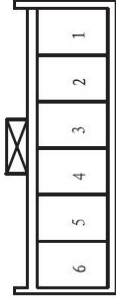

- 1. ---
- 2. V ESC Switch signal
- 3. RBr ON power
- 4. ---
- 5. B0 Backlight -
- 6. Y0 Backlight +

M25 ESP-HDC switch

- 6 Female/light grey

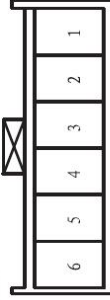

- 1. ---
- 2. V HDC switch signal
- 3. RBr ON power
- 4. ---
- 5. B0 Backlight-
- 6. Y0 Backlight +

Main wire harness (6)

M40 Front glass electric heating switch

- 6 Female/grey

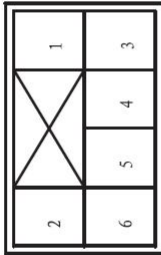

- 1. L Signal input terminal
- 2. B0 Backlight-
- 3. W0 Defrost signal
- 4. B Workplace
- 5. B Workplace
- 6. Y0 Backlight- and so on

M22

- 52 Female/black

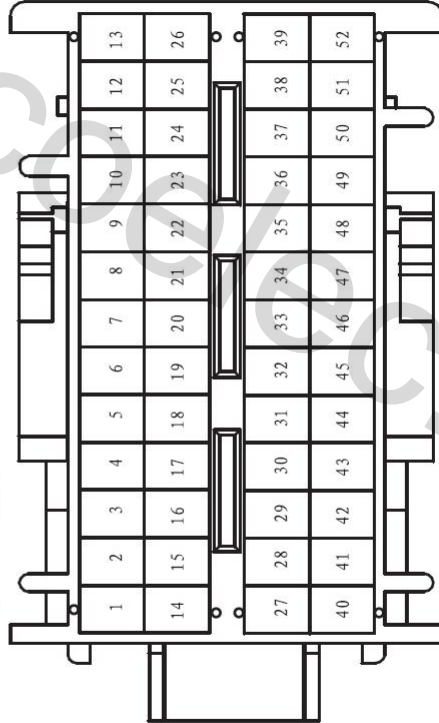

- 1. ---
- 2. RGr I G2 power supply
- 3. W0 Fog lamp switch
- 4. B Signal grounding
- 5. R Left turning lamp switch
- 6. ---
- 7. RGr ACC Power Supply
- 8. RBr I G1 power supply
- 9. G Warning Lamp Switch
- 10. P Rear wiper switch
- 11. ---
- 12. ---
- 13. RG Front wiper high speed switch
- 14. ---
- 15. ---
- 16. Br Front wiper low speed switch
- 17. ---
- 18. ---
- 19. ---
- 20. -
- 21. Y0 Front wiper intermittent switch
- 22. L Generator L terminal

Mai harness (7)

- 23. 0B Front wiper inch switch
- 24. 0 Backup signal
- 25. ---
- 26. L Front defrost switch
- 27. Gr Ignition lock lighting
- 28. ---
- 29. RO Front wiper intermittent adjustment
- 30. G Headlamp low beam switch
- 31. GO Small light switch
- 32. YW Lighting AUTO gear
- 33. PB Rear fog light switch
- 34. RO Left turning light switches
- 35. ---
- 36. ---
- 37. L Rear water injecting switch
- 38. WR Rear defrost signal
- 39. ---
- 40. ---
- 41. W CAN-L
- 42. BR CAN-H
- 43. ---
- 44. ---

- 45. PB Front wiper intermittent time adjustment
- 46. C Solar signal input
- 47. P Headlamp high beam lamp switch
- 48. ---
- 49. Y Rear wiper intermittence
- 50. O Front water injecting switch
- 51. ---
- 52. ---

M17/Mode valve motor

— 6 Female/blue

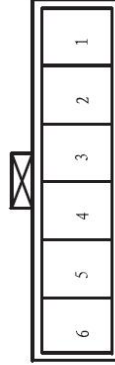

- 1. B Sensor ground wire
- 2. GO Air-conditioning control module (feedback)
- 3. GW Air-conditioning control module (sensor power supply)
- 4. ---
- 5. P Air-conditioning control module (motor negative middle air inlet)
- 6. LY Air-conditioning control module (motor positive upper air inlet)

Main wire harness (8)

M18 CCD player

- 16 Female/White

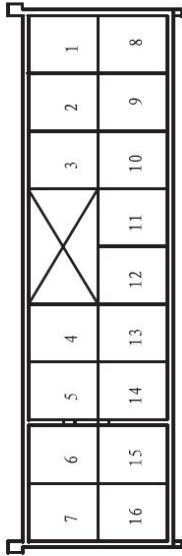

- 1. LR Antenna amplifier power supply
- 2. Br Left rear audio+
- 3. G Left front audio+
- 4. GB Right front audio+
- 5. G Right rear audio+
- 6. BO Small light -
- 7. RGr ACC power supply
- 8. B Ground wire
- 9. W Left rear audio-
- 10.R Left front audio-
- 11. -- --
- 12. -- --
- 13.RB Right front audio-
- 14.0 Right rear audio-
- 15.YO Small light+
- 16. R Memory power supply

M19 Buzzer

- 3 Female/White

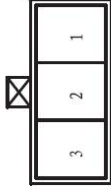

- 1. Y High potential
- 2. -- --
- 3. 0 Low potential

M20 Cigarette lighter

- 2 Female/black

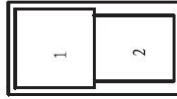

- 1. B Grounding
- 2. RGr Power

M41 Cigarette lighter Lighting ring

- 1 Female/White

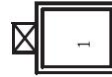

- 1. R Power (indoor fuse box)

Main wire harness (9)

M21 On-board power supply

- 2 Female/White

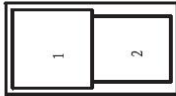

1. B Ground wire

2. Rgr Power

M23 BCM-2

- 48 Female/black

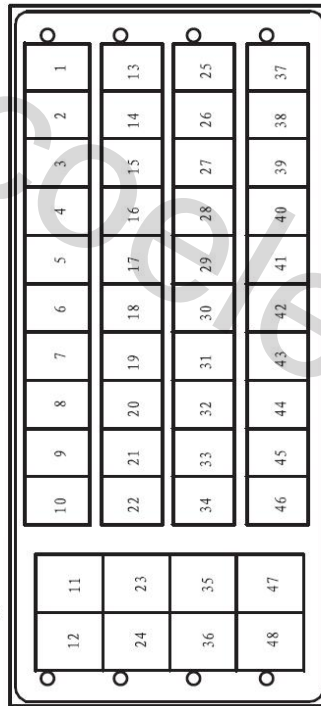

1. ---

2. --- Rear fog lamp relay

3. ---

4. --- Signal ground wire

9. ---	29. ---
10. ---	30. ---
11. RG Right rear turning light +	31. Br Front wiper high speed relay
12. Br Ceiling light +	32. ---
13. W Brake lamp	33. ---
14. ---	34. ---
15. ---	35. R0 Right front turning light+
16. ---	36. ---
17. Gr Front wiper relay	37. ---
18. ---	38. ---
19. ---	39. ---
20. ---	40. ---
21. L Front wiper return switch	41. Br Flashing relay
22. ---	42. ---
23. RY Left rear turning light +	43. Y Buzzer
24. R Left front turning light +	44. ---
25. R High-mounted brake lamp	45. P Key insert switch
26. ---	46. L LIN2
27. ---	47. ---
28. ---	48. R Brake lamp

Main wire harness (10)

M24 BCM-3

- 22 Female/black

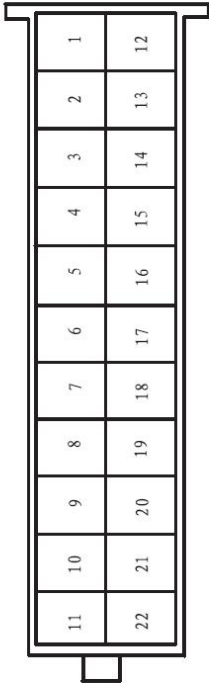

- 1. R B+
- 2. G B+
- 3. ---
- 4. B GND
- 5. ---
- 6. ---
- 7. ---
- 8. ---
- 9. ---
- 10. ---
- 11. ---
- 12. ---
- 13. ---
- 14. ---
- 15. ---
- 16. ---
- 17. ---
- 18. ---
- 19. ---
- 20. ---
- 21. ---
- 22. ---

M08 Combination switch 2

- 14 Female/White

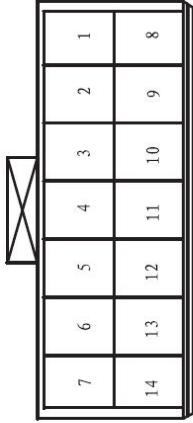

- 1. 0B Inch
- 2. ---
- 3. Br Wiper low speed
- 4. ---
- 5. L Rear washing
- 6. B GND
- 7. Y Rear wiper adjustment
- 8. Y0 Wiper intermittent adjustment
- 9. RG Wiper high speed
- 10. B Front wiper washing power switch
- 11. 0 Washing switch
- 12. BB Wiper intermittent adjusting switch
- 13. R0 Wiper intermittent time adjustment
- 14. P Rear wiper switch

Main wire harness (11)

M07 Combination Switch 1

- 13 Female/White

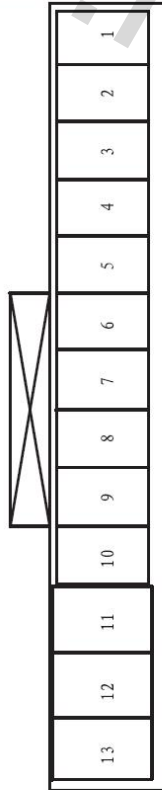

- 1. B Lighting switch grounding
- 2. G0 Small Lamp
- 3. YW Auto-sensing
- 4. G Headlamp switch
- 5. B Front rear fog switch ground wire
- 6. W0 Front fog lamp switch
- 7. PB Rear fog lamp switch
- 8. ---
- 9. G High beam light
- 10. P Small lamp switch
- 11. R0 Left turn
- 12. B Turning light switch
- 13. R Right turn

M03 Ignition Switch

- 6 Female/natural color

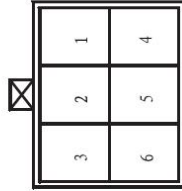

- 1. R B+ 4. W IG1
- 2. RB IG2 5. R B+
- 3. L ST 6. 0 ACC

M13 Key insert switch

- 6 Female/White

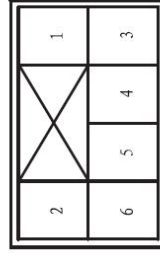

- 1. --- 4. P Key insert switch +
- 2. --- 5. B Lighting ring -
- 3. L Key insert switch - 6. Gr Lighting ring +

Main harness (12)

M02 驾驶员的座椅时钟安全气囊

- 4 Female/yellow

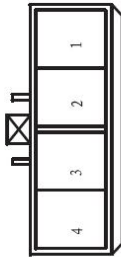

- 1. BR DAB+
- 2. BR DAB-
- 3. ---
- 4. ---

M09 EPS-A

- 4

Female/black

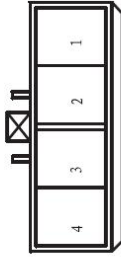

- 1. ---
- 2. YR CAN-L
- 3. GrR CAN-H
- 4. RBr ICI

M12

Clock spring

- 12 Female/White

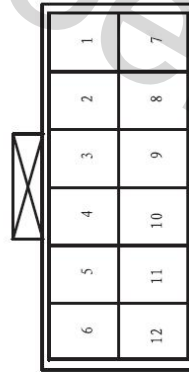

- 1. ---
- 2. ---
- 3. ---
- 4. ---
- 5. ---
- 6. ---
- 7. ---
- 8. B0 /Small light
- 9. Y0 /Small light
- 10. B LINE-GND
- 11. RW LINE-CON
- 12. Gr Hom

M10

EPS-B

- 2

Female/black

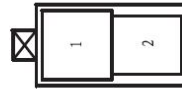

- 1. R Power
- 2. B Grounding

Main wire harness (13)

M11 Combination instrument

- 32 Female/blue

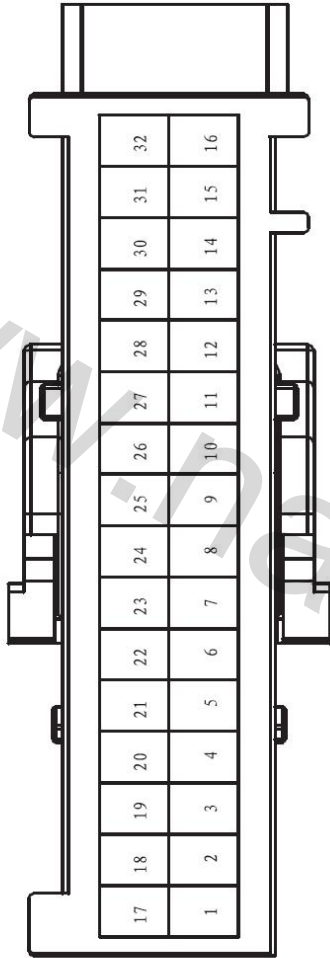

- | | | |
|------------------------------|-------------------------------|--------------------------------|
| 1. -- -- | 13. -- -- | 25. L0 Fuel signal |
| 2. -- -- | 14. -- -- | 26. -- -- |
| 3. -- -- | 15. -- -- | 27. -- -- |
| 4. -- -- | 16. -- -- | 28. -- -- |
| 5. GrR PCAN-H | 17. -- -- | 29. V Charging indicator light |
| 6. YR PCAN-L | 18. R B+ | 30. G Oil pressure alarm |
| 7. -- -- | 19. RBr IG1 | 31. -- -- |
| 8. Br BCAN-H | 20. -- -- | 32. -- -- |
| 9. W BCAN-L | 21. B0 Interior lighting + | |
| 10. -- -- | 22. Y0 Interior lighting - | |
| 11. 0 Send to reception TPMS | 23. B Instrument ground wire | |
| 12. L Send to TPMS reception | 24. B Fuel sensor ground wire | |

Main wire harness (14)

M06 Rearview mirror adjust switch

- 16 Female/blue

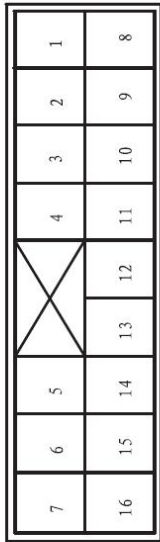

- 1. ---
- 2. GB Driver's seat UP/DOWN adjustment
- 3. W Passenger's seat UP/DOWN adjustment
- 4. P Passenger's seat left/right adjustment
- 5. LG Driver's seat left/right adjustment
- 6. GY Driver's seat common terminal
- 7. OG Passenger's seat common terminal
- 8. G0 Driver's seat electric folding
- 9. LR Passenger's seat electric folding
- 10. 0 Driver's seat folding reset
- 11. 0R Passenger's seat folding reset
- 12. B Ground wire
- 13. R Power
- 14. ---
- 15. ---
- 16. ---

M04 Dimming switch

- 6 Female/White

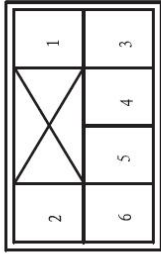

- 1. ---
- 2. ---
- 3. B Grounding
- 4. B0 Small light -
- 5. B0 Small lamp -
- 6. Y0 Small light+

M05 Headlamp adjusting switch

- 6 Female/blue

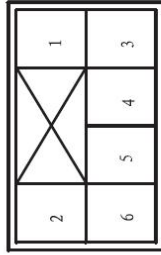

- 1. B Grounding
- 2. P Low beam +
- 3. B0 Small lamp -
- 4. W Left front electric adjusting control
- 5. W Right front electric adjusting control
- 6. Y0 Small light+

Main wire harness (15)

M01 OBD-II

-- 16 Female/black

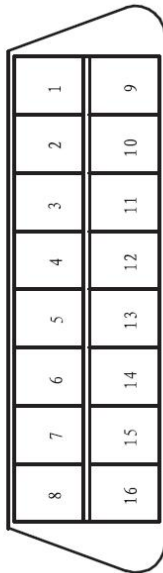

- 1. -- --
- 2. -- --
- 3. W BCAN-L
- 4. -- --
- 5. -- --
- 6. YR PCAN-L
- 7. -- --
- 8. R Diagnosis port power
- 9. -- --
- 10. -- --
- 11. Br BCAN-H
- 12. B Ground wire
- 13. B Ground wire
- 14. GrR PCAN-H
- 15. Br K wire
- 16. -- --

www.nasicoelec.ir

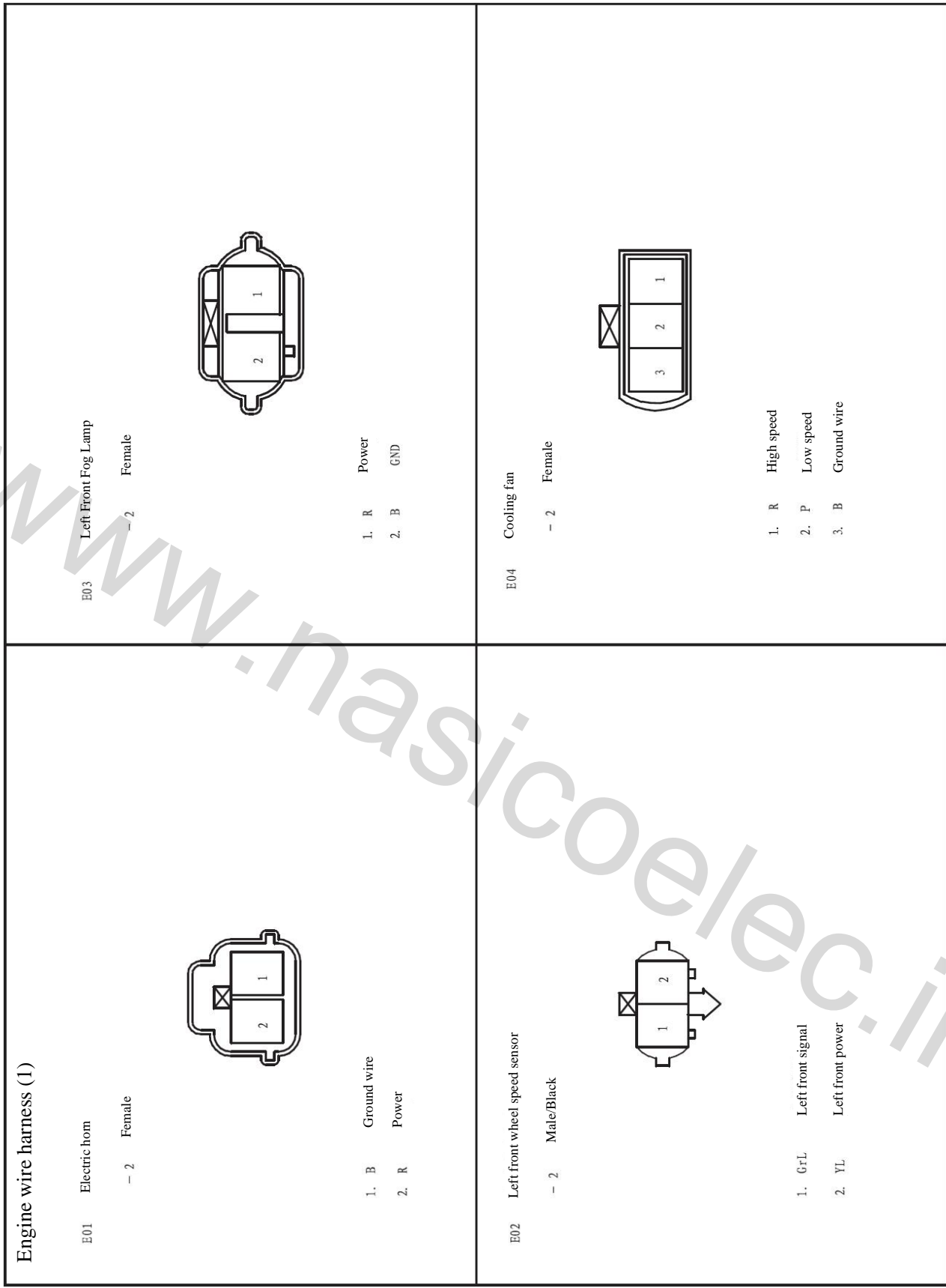

Engine wire harness (2)

E05 Left front combination lamp

- 9 Female

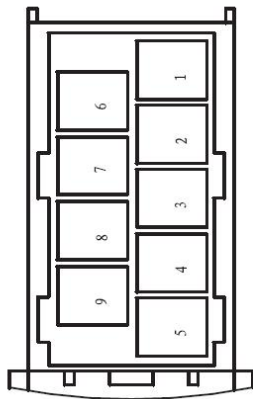

- 1. Y Low beam +
- 2. Y Electric adjusting +
- 3. B Low beam-turning-
- 4. B High beam-position-
- 5. R Turning +
- 6. 0 High beam +
- 7. W Electric adjusting control
- 8. L0 Position +
- 9. B Electric adjusting -

E06 Washing pump

- 3 Female

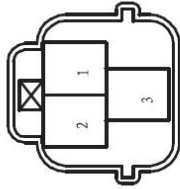

- 1. 0 Washing switch
- 2. RGr IG2
- 3. L Rear washing

E07 Three-way pressure switch

- 4 Female

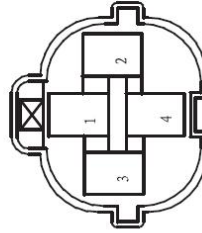

- 1. WL High pressure
- 2. YB Intermediate voltage
- 3. B Ground wire
- 4. L A/C request

Engine wire harness (3)

E08 Accelerator pedal

- 6 Female

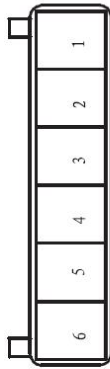

- 1. 0 PPS2
- 2. Br V5 RTN2
- 3. P PPS1
- 4. W V5 RTN1
- 5. L V5 REF1
- 6. Y V5 REF2

E10 Vacuum pump motor

- 2 Female

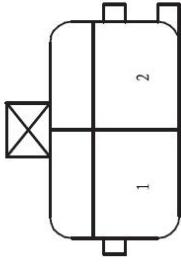

- 1. 0 Power
- 2. B GND

E09 Front wiper motor

- 4 Female

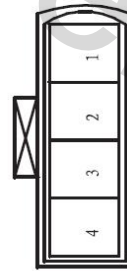

- 1. B GND
- 2. L Return
- 3. Y Low speed
- 4. W High speed

E11 Brake switch

- 4 Female

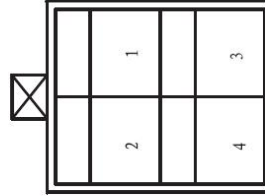

- 1. W Brake lamp
- 2. Y B+
- 3. LR Brake switch
- 4. P IGI

Engine wire harness (4)

E12 ABS module

- 47 Female

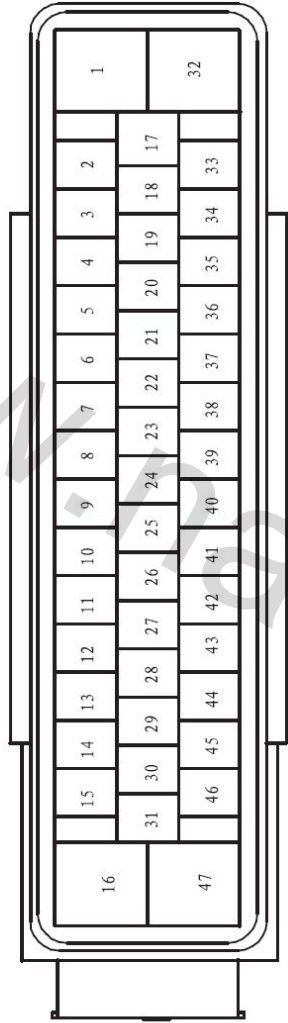

1. R B+	13. YR CAN-L	25. -- --	36. GrB Left rear power
2. -- --	14. -- --	26. -- --	37. RB Left rear signal
3. -- --	15. -- --	27. -- --	38. W Brake switch
4. -- --	16. -- --	28. -- --	39. V ESC switch
5. -- --	17. -- --	29. -- --	40. -- --
6. Y HDC switch	18. -- --	30. -- --	41. -- --
7. -- --	19. -- --	31. -- --	42. GrB Right rear signal
8. RBr IGI	20. -- --	32. R B+	43. GrR Right rear power
9. -- --	21. -- --	33. BrB Right front signal	44. -- --
10. Br K wire	22. -- --	34. BrW Right front power	45. YL Left front power
11. -- --	23. -- --	35. -- --	46. GrL Left front signal
12. GrR CAN-H	24. -- --		47. B GND

Engine wire harness (5)

E13 Right front wheel speed sensor
- 2 Male/Black

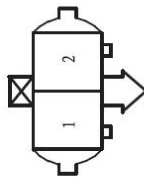

1. BrB Right front signal
2. BrW Right front power

E14 Right front fog lamp
- 2 Female

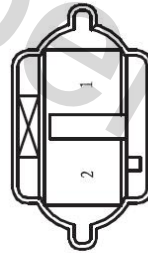

1. R Power
2. B GND

E15 Right front combination lamp
- 9 Female

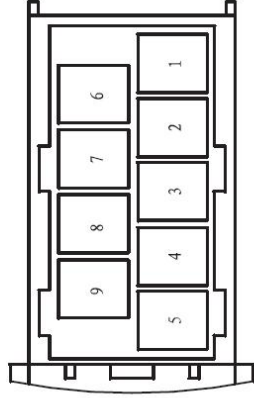

1. LR	Low beam+
2. LR	Electric adjusting +
3. B	Low beam-turning-
4. B	High beam-position-
5. RO	Turning +
6. P	High beam +
7. L	Electric adjusting control
8. LY	Position +
9. B	Electric adjusting -

Engine wire harness (6)

E16 Compressor

- 1 Female/black

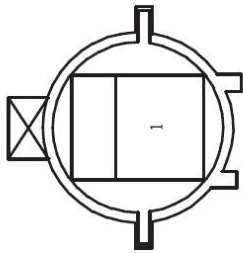

1. Br Compressor power

E18 Clutch pedal 1

- 2 Female

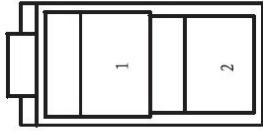

1. RBr IG1
2. G Clutch pedal signal 1

E17 Brake fluid level sensor

- 2 Female/black

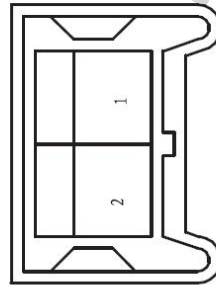

1. B GND
2. Y Indoor fuse box (sensor +)

E19 Clutch pedal 2

- 2 Female

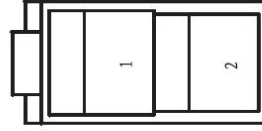

1. V IG1
2. Lg Clutch pedal signal 2

Engine wire harness (7)

CE02 Control wire harness (A)

- 16 Male/Black

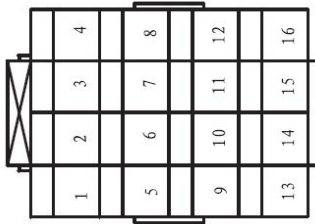

- 1. LR Brake switch 9. P Electrical accelerator pedal
- 2. W Brake lamp 10. L Electrical accelerator pedal
- 3. -- -- 11. RBr 161
- 3. -- -- 12. Y Headlamp signal
- 5. Gr A/C Relay 13. W Electrical accelerator pedal
- 6. WL A/C high-low pressure signal 14. Y Electrical accelerator pedal
- 7. G Clutch pedal switch 15. 0 Electrical accelerator pedal
- 8. YB Intermediate A/C voltage signal 16. Br Electrical accelerator pedal

CE01 Control wire harness (B)

- 16 Male/Grey

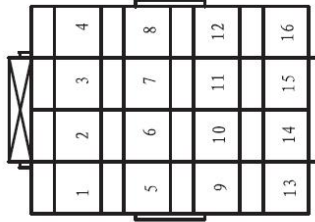

- 1. R B+ 9. GrR CAN-H
- 2. Y High speed fan relay 10. Y0 Blower signal
- 3. Gr Low speed fan relay 11. -- -- Clutch pedal switch
- 4. 0 K wire 12. Lg CAN-L
- 5. L Main relay 13. YR CAN-L
- 6. G Fuel pump relay 14. -- --
- 7. Br Start relay 15. R Main relay output
- 8. Y0 Vacuum pump relay 16. RBr Main relay output

Engine wire harness (8)

E22 CAN Wire connector
 - 8 Female/black

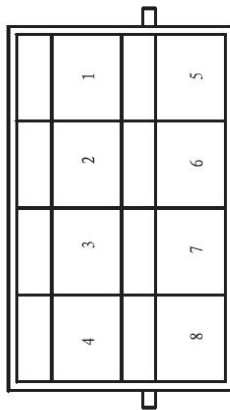

1. -- --
2. GrR ECU CAN-H
3. GrR CAN-H
4. GrR CAN-H
5. -- --
6. YR CAN-L
7. YR CAN-L
8. YR CAN-L

www.nasicoelec.ir

Frame wire harness (1)

F01 Right rear outside combination lamp

- 6 Female

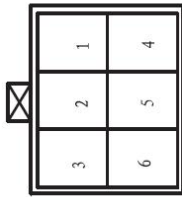

- 1. B Brake lamp -
- 2. B Right rear position light -
- 3. B Right turning light -
- 4. RG Right turning light +
- 5. R Right rear position lamp+
- 6. RL Brake lamp +

F03 Fuel sensor ground wire and fuel pump motor

- 4 Female

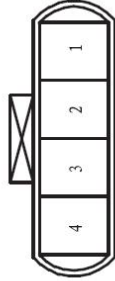

- 1. B Fuel pump -
- 2. P Fuel pump+
- 3. B Sensor-
- 4. L0 Sensor+

F02 Left rear t outside combination lamp

- 6 Female (D7706-1.8-21)

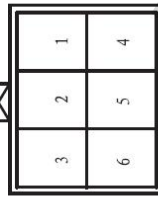

- 1. B Brake lamp -
- 2. B Left rear position light
- 3. B Left turning light -
- 4. RY Left turning light+
- 5. R Left rear position light+
- 6. RL Brake lamp +

F04 Wire connector

- 8 Female/black

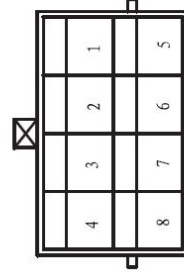

- 1. -- --
- 2. GrR CAN-H
- 3. GrR CAN-H
- 4. GrR CAN-H Airbags
- 5. -- --
- 6. YR CAN-L
- 7. YR CAN-L
- 8. YR CAN-L Airbags

Frame wire harness (2)

F05 Airbag ECU

- 32 Female

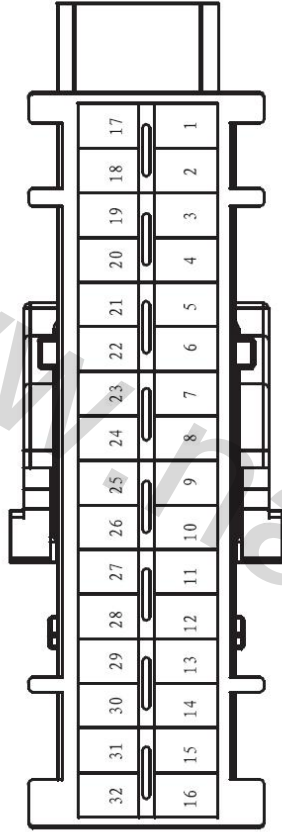

1. BrC	DAB +	13. ---	---	25. ---	---
2. BrR	DAB -	14. ---	---	26. ---	---
3. O	PAB +	15. ---	---	27. ---	---
4. Y	PAB -	16. ---	---	28. GrR	CAN-H
5. Gr	DBT+ (driver seat belt +)	17. ---	---	29. YR	CAN-L
6. GrB	DBT- (driver's seat belt -)	18. ---	---	30. B	GND
7. Y	PBT+ (passenger's seat belt +)	19. ---	---	31. ---	---
8. L	PBT- (passenger seat belt -)	20. ---	---	32. RBr	IG1
9. ---	---	21. ---	---		
10. ---	---	22. ---	---		
11. ---	---	23. ---	---		
12. ---	---	24. ---	---		

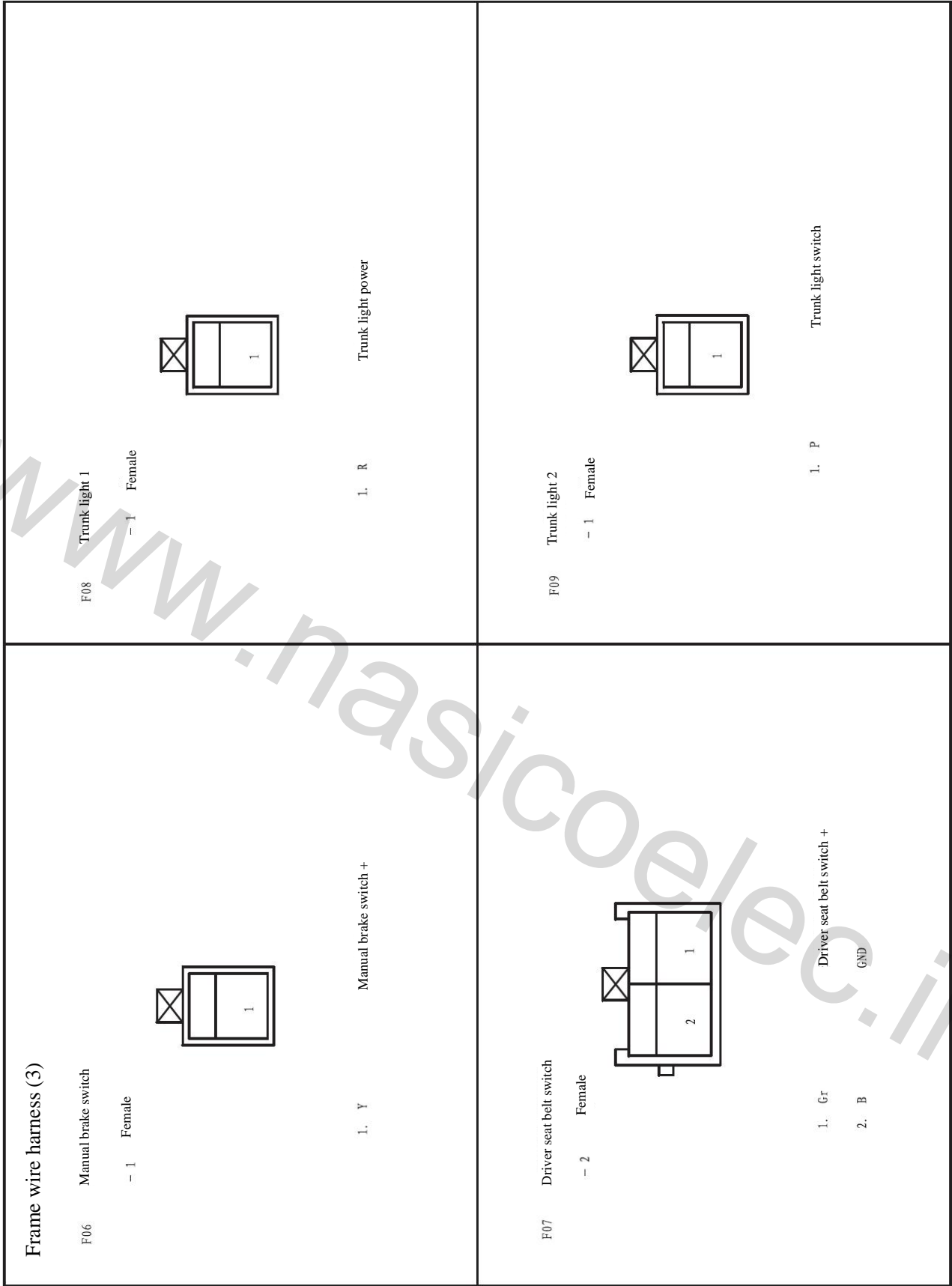

www.nasicoe.com

Frame wire harness (4)

F10 Left rear door contact switch

- 2 Female/White

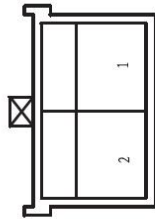

1. L Left rear door contact switch +

2. B GND

F12 Right rear door contact switch

- 2 Female/White

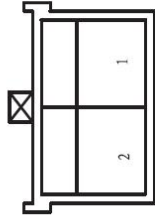

1. P Right rear door contact switch +

2. B GND

F11 Left rear wheel speed sensor

- 2 Female/black

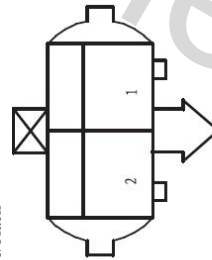

1. GrB Left rear power

2. RB Left rear signal

F13

Right rear wheel speed sensor

- 2 Female/black

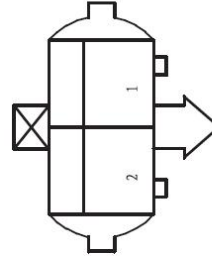

1. GrR Right rear power

2. GrB Right rear signal

Frame wire harness (5)

F14 Left front door contact switch

- 2 Female/White

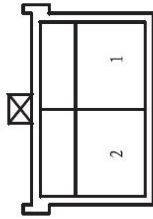

- 1. 0 Left front door contact switch +
- 2. B GND

F16 Right front door contact switch

- 2 Female/White

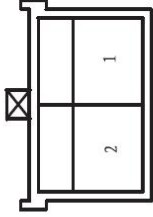

- 1. W Right front door contact switch +
- 2. B GND

F15 Left pretension signal seatbelt

- 2 Female

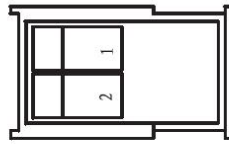

- 1. GrB Left seat belt pretension signal
- 2. Gr Left seat belt pretension signal

F17 Right pretension seatbelt

- 2 Female

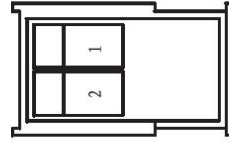

- 1. L Right seat belt pretension signal
- 2. Y Right seat belt pretension signal

Ceiling wire harness (1)

R01 Rear ceiling light
- 6 Female

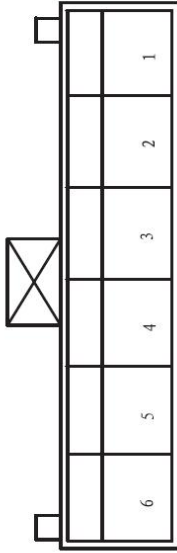

- 1. --- ---
- 2. --- ---
- 3. R Rear ceiling light power
- 4. --- ---
- 5. B GND
- 6. 0 Front ceiling light -

R02 Front ceiling light
- 6 Female

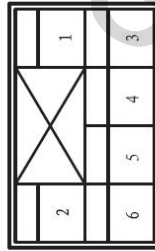

- 1. --- ---
- 2. --- ---
- 3. B GND
- 4. R Front ceiling light, sunvisor power
- 5. 0 Rear ceiling light -
- 6. Br Ceiling light center control

R03 Left sunvisor
- 2 Female

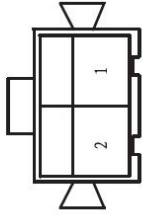

- 1. B GND
- 2. R Sunvisor light power

R04 Right sunvisor
- 2 Female

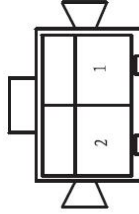

- 1. B GND
- 2. R Sunvisor light power

Ceiling wire harness (2)

R05 Sunroof switch

- 6 Female/White

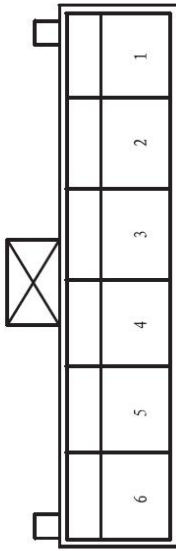

- 1. B GND
- 2. Y Sunroof OFF/UP switch
- 3. L Sunroof ON/DOWN switch
- 4. --- GND
- 5. --- Sunroof OFF/UP switch
- 6. --- Sunroof ON/DOWN switch

R06 Interior rearview mirror

- 6 Female/White

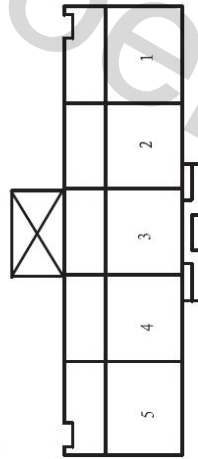

- 1. 0 Reversing signal
- 2. RGr Power IG2
- 3. --- GND
- 4. --- Reversing signal
- 5. B GND

R07 Sunroof controller

- 10 Female

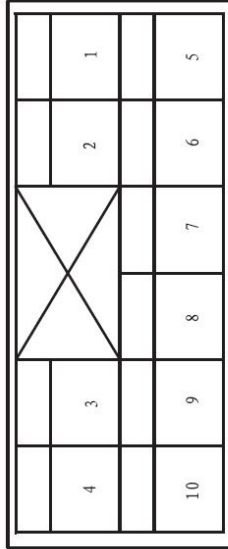

- 1. --- GND
- 2. --- GND
- 3. B GND
- 4. R Sunroof controller power supply B+
- 5. --- GND
- 6. Y Sunroof OFF/UP switch signal
- 7. --- GND
- 8. L Sunroof ON/DOWN switch signal
- 9. --- GND
- 10. RGr Sunroof controller power supply IG2

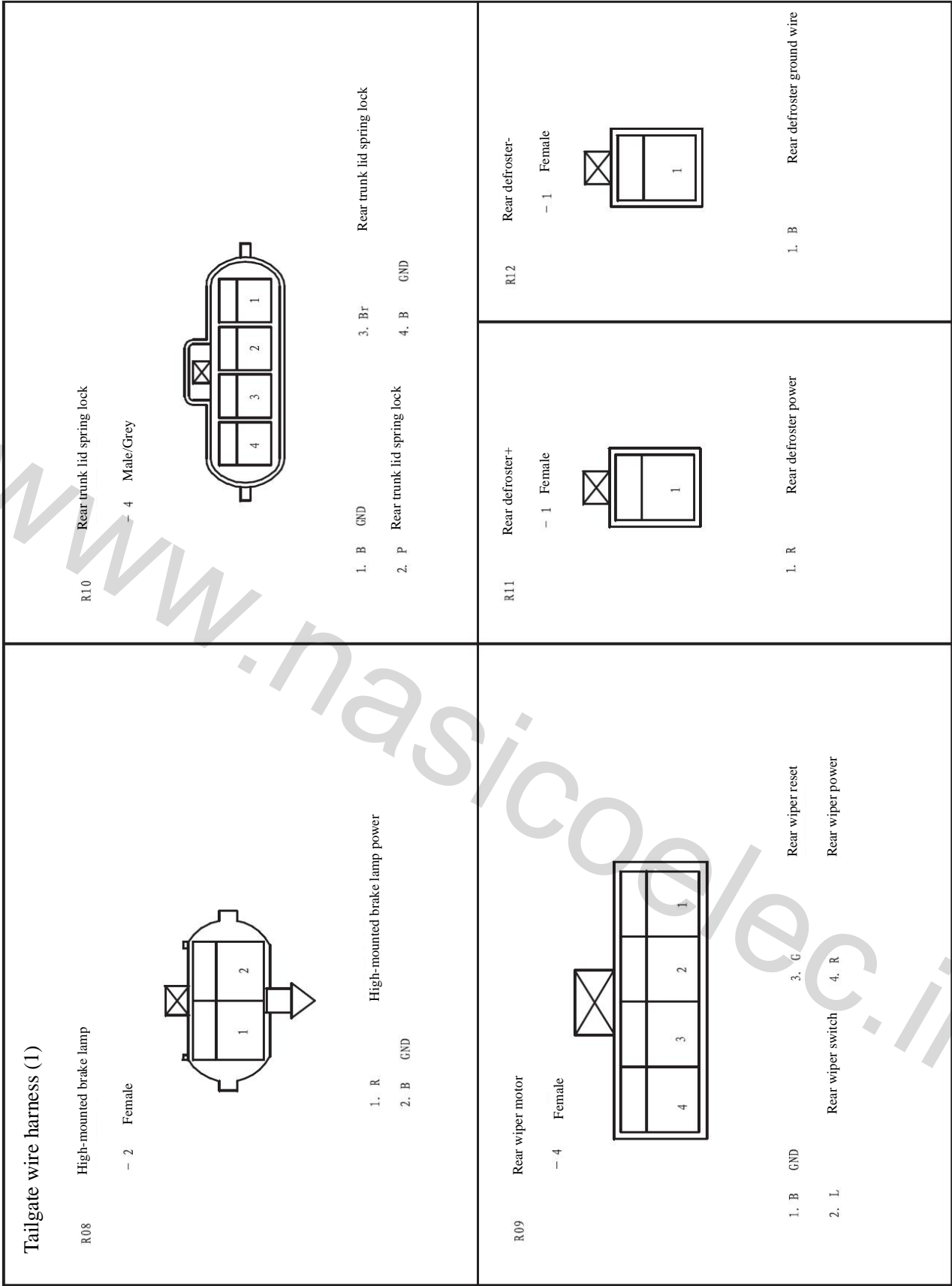

Tailgate wire harness (2)

R13 Left rear inside combination lamp

- 6 Female

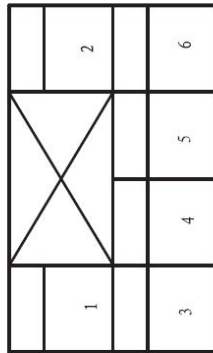

- 1. RL Brake lamp +
- 2. RY Left turning light +
- 3. R Left position light+
- 4. B Left position light-
- 5. B Brake lamp -
- 6. B Turning light -

R14 Right rear inside combination lamp

- 6 Female

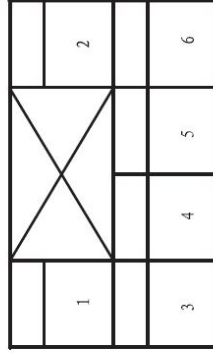

- 1. RL Brake lamp +
- 2. RG Right turning light +
- 3. R Right position light +
- 4. B Right position light -
- 5. B Brake lamp -
- 6. B Turning light -

Tailgate wire harness (3)

R15 Connect to tailgate switch harness

— 8 Female

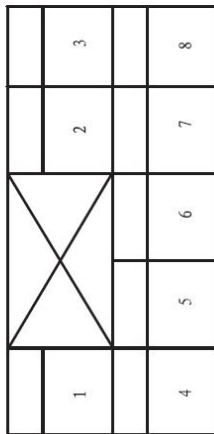

1. B GND

2. — —

3. R License platelight power

4. B GND

5. — —

6. — —

7. — —

8. Y Tailgate switch

www.nasicoelec.ir

Reversing radar wire harness (1)

R16 Left rear fog lamp

- 6 Female/black

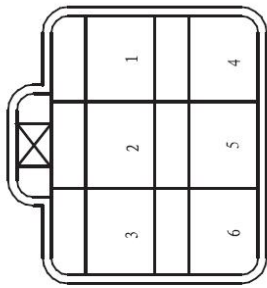

- 1. RW Reversing light +
- 2. - -
- 3. B Reversing light -
- 4. R Fog lamp +
- 5. - -
- 6. B Fog lamp -

R17 Right rear fog lamp

- 6 Female/black

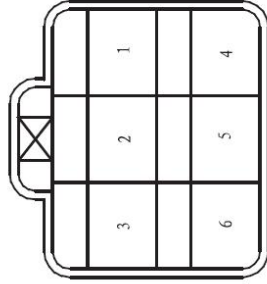

- 1. RW Reversing light +
- 2. - -
- 3. B Reversing light -
- 4. R Fog lamp +
- 5. - -
- 6. B Fog lamp -

Reversing radar wire harness (2)

R18

Left rear radar sensor

- 4 Female

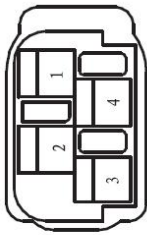

- | | | | |
|------|-------|-------|--------|
| 1. R | Power | 3. L | Signal |
| 2. B | GND | 4. RO | Output |

R19

Left rear intermediate radar sensor

- 4 Female

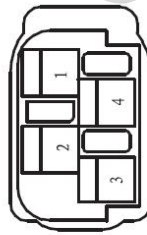

- | | | | |
|-------|-------|-------|--------|
| 1. RO | Power | 3. L | Signal |
| 2. B | GND | 4. RL | Output |

R20

Right rear radar sensor

- 4 Female

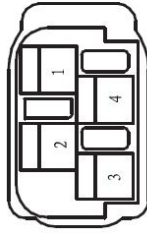

- | | | | |
|-------|-------|-------|--------|
| 1. RG | Power | 3. L | Signal |
| 2. B | GND | 4. -- | -- |

R21

Right rear intermediate radar sensor

- 4 Female

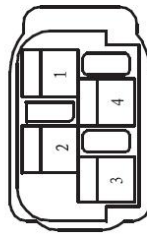

- | | | | |
|-------|-------|------|--------|
| 1. RL | Power | 3. L | Signal |
| 2. B | GND | 4. | |

Left front door wire harness (1)

D01 Driver's seat door speaker
- 2 Female

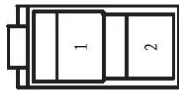

1. R/R Driver's seat door low/high pitch speaker -
2. G/G Driver's seat door low/high pitch speaker +

D02 Door light
- 2 Female

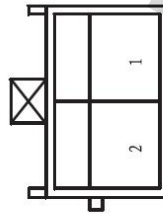

1. 0B Door light-
2. R Door light+

D03 Glass lifter
- 2 Female

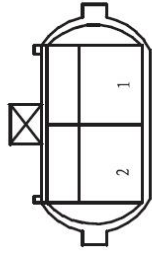

1. WG Left front glass DOWN terminal
2. W0 Left front glass UP terminal

D04 Driver's seat door high hitch speaker
- 2 Female/White

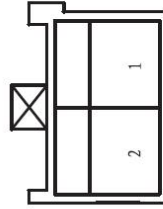

1. G Speaker +
2. R Speaker -

Left front door wire harness (2)

D05 Driver's seat door lock actuator
- 10 Female

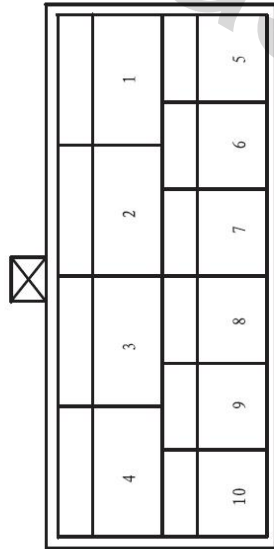

- 1. Br Door lock actuator motor
- 2. ---
- 3. ---
- 4. Gr Door lock actuator motor
- 5. YB Key switch
- 6. BrW Key switch
- 7. B0 Door lock status switch
- 8. B GND
- 9. ---
- 10. ---

D06 Driver seat outer electric rearview mirror
- 8 Female

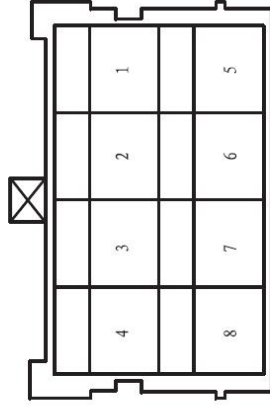

- 1. ---
- 2. ---
- 3. RY Turning Signal Light +
- 4. B GND
- 5. R Optic heating wire
- 6. LG Rearview mirror left/right adjusting
- 7. GY Rearview mirror adjust power
- 8. GB Rearview mirror UP/DOWN adjusting

Left front door wire harness (3)

D07 Electric door window master switch

- 16 Female

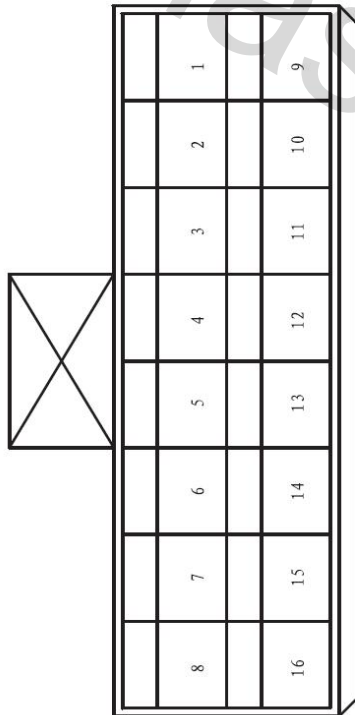

- 1. 0 Right front glass DOWN terminal
- 2. B GND
- 3. RG Right front glass UP terminal
- 4. R B+ (RH)
- 5. W B+ (LH)
- 6. ---
- 7. WG Left front glass DOWN terminal
- 8. WO Left front glass UP terminal
- 9. Y Right rear glass UP terminal
- 10. WR Right rear glass DOWN terminal
- 11. G Left rear glass UP terminal
- 12. BO Small light -
- 13. YO Small light+
- 14. L Left rear glass DOWN terminal
- 15. RO Door lock
- 16. YW Door unlock

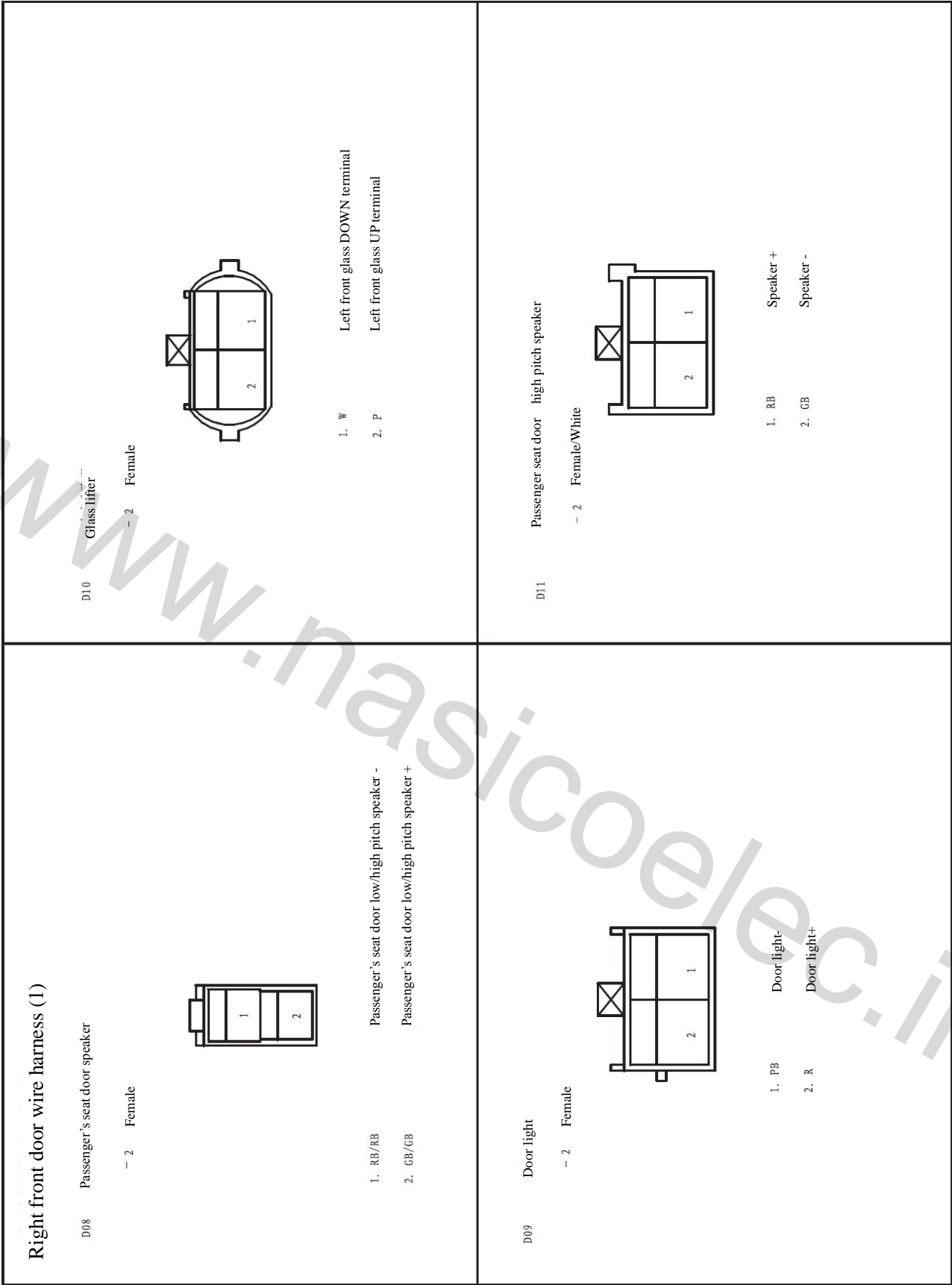

Right front door wire harness (2)

D12 Passenger seat door lock actuator

- 10 Female

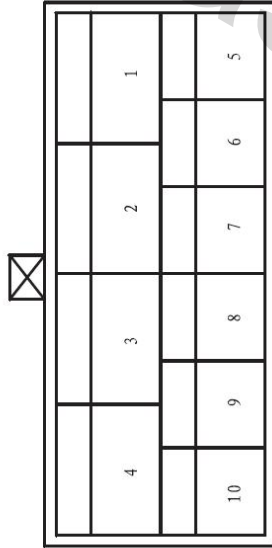

- 1. Br Door lock actuator motor
- 2. ---
- 3. ---
- 4. Gr Door lock actuator motor
- 5. ---
- 6. ---
- 7. ---
- 8. ---
- 9. ---
- 10. ---

D13 Passenger seat outer electric Rearview mirror

- 8 Female

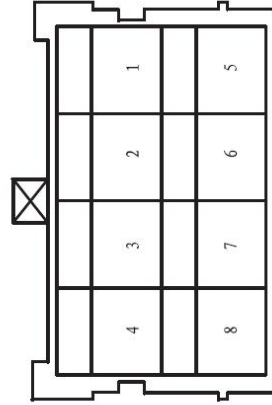

- 1. ---
- 2. ---
- 3. RY Turning signal light +
- 4. B GND
- 5. R Optic heating wire
- 6. LG Rearview mirror left right adjusting
- 7. GY Rearview mirror adjust power
- 8. GB Rearview mirror UP/DOWN adjusting

Right front door wire harness (3)

D14 Passenger's seat electric door window switch

- 8 Female

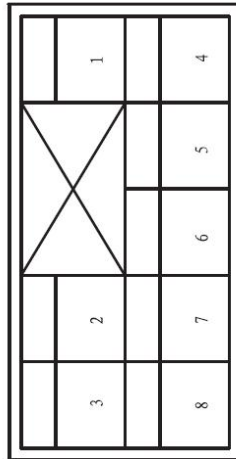

1. P Left front glass UP terminal

2. — —

3. W Left front glass DOWN terminal

4. 0 Right front glass DOWN terminal

5. Y0 Small light+

6. R B+ (RH)

7. B0 Small light -

8. RC Right front glass UP terminal

Rear door glass wire harness (1)

D15 Rear door speaker
- 2 Female

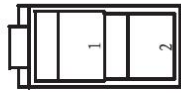

1. Br Rear door low pitch speaker -
2. W Rear door low pitch speaker +

D16 Glass lifter
- 2 Female

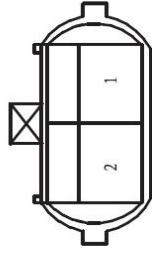

1. 0 Left front glass DOWN terminal
2. W Left front glass UP terminal

Rear door glass wire harness (2)

D17 Rear door lock actuator

- 10 Female

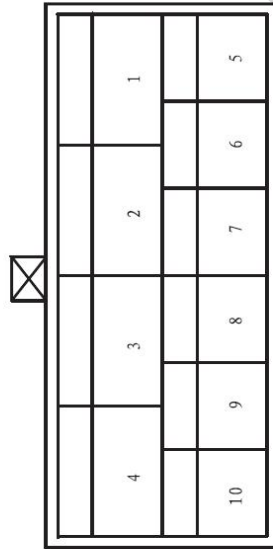

- 1. Br Door lock actuator motor
- 2. ---
- 3. ---
- 4. Gr Door lock actuator motor
- 5. ---
- 6. ---
- 7. ---
- 8. ---
- 9. ---
- 10. ---

D18 Rear door electric door/window switch

- 8 Female

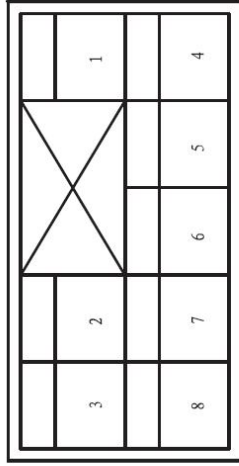

- 1. W Left front glass UP terminal
- 2. ---
- 3. O Left front glass DOWN terminal
- 4. G Left rear glass DOWN terminal
- 5. ---
- 6. Y Glass UP/DOWN motor
- 7. ---
- 8. L Left rear glass UP terminal

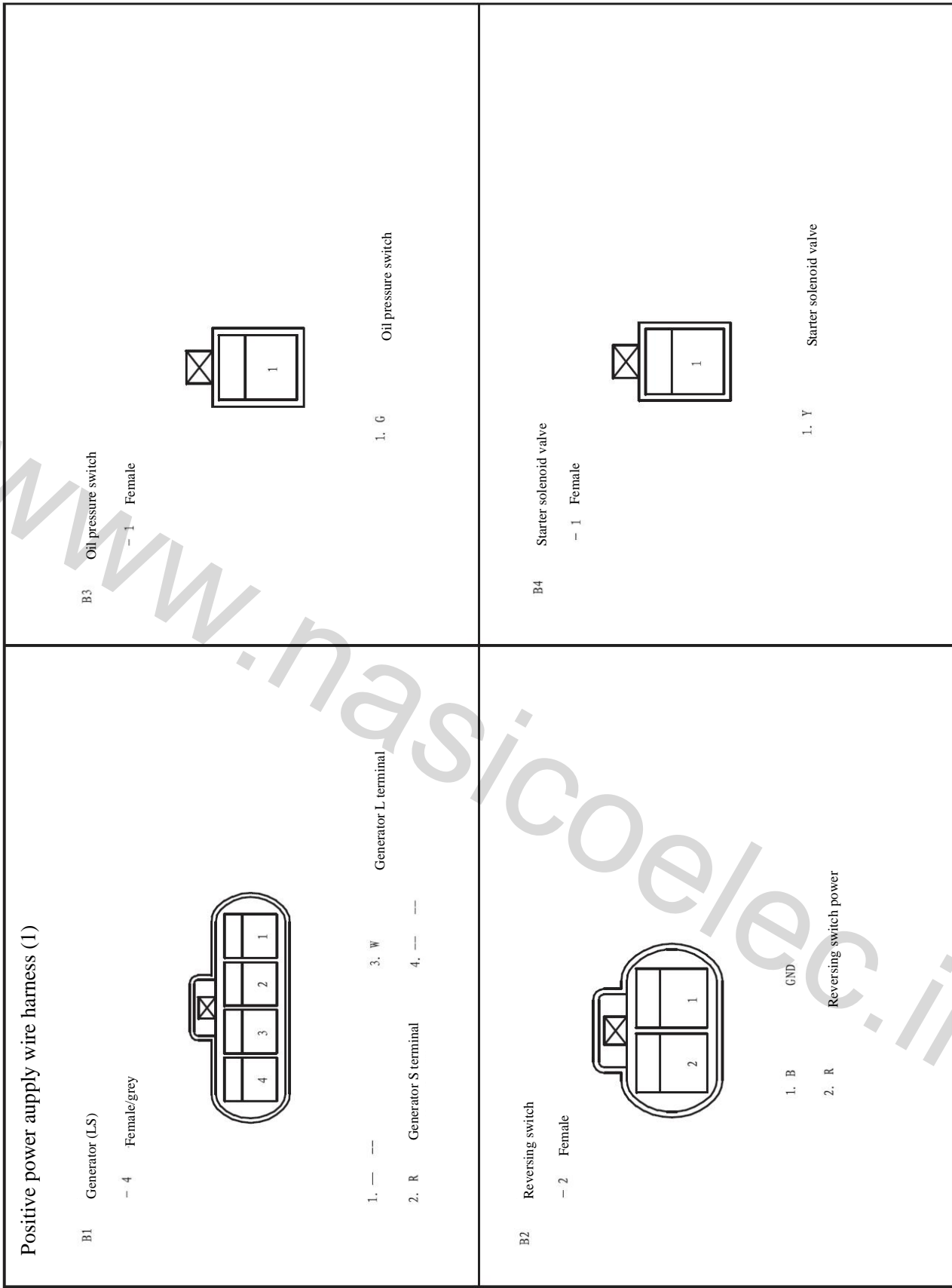

Positive power supply wire harness (2)

B5 Generator

- 1 Female

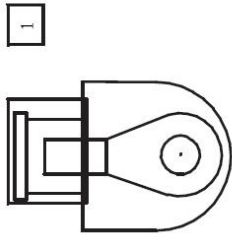

1. B Generator power

B7 Positive power supply

- 1 Female

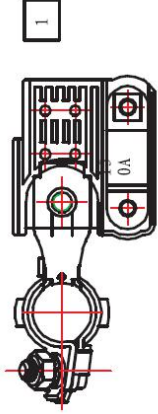

1. B Starter & Outdoor electrical box power

B6 Starter

- 1 Female

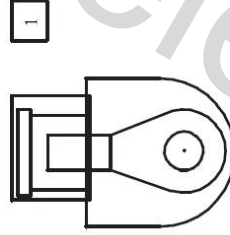

1. B Starter power

B8 Connect to engine front compartment indoor fuse box

- 1 Female

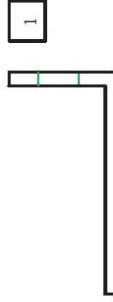

1. B Outdoor electrical box power

Negative power supply wireharness (1)

B9 Negative power supply connector

- 1 Female

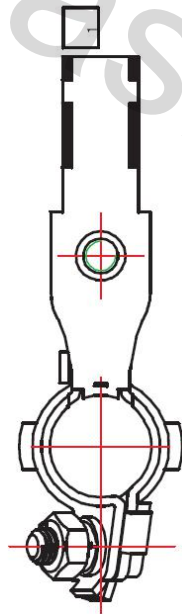

1. B Negative power supply

B10 Negative power supply

- 1 Female

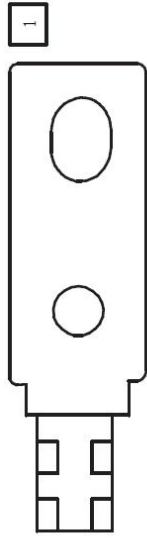

1. B Negative power supply body ground wire point

Wire harness connection (1)

- BE01 Positive power supply wire harness connect with engine wire harness
- 18 Female
 - Positive power supply harness

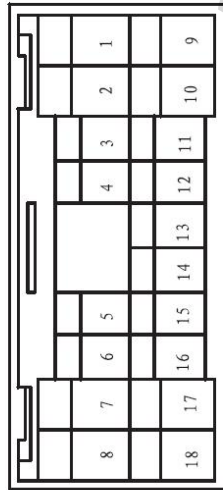

- 18 Male (MG644429)
- Engine wire harness

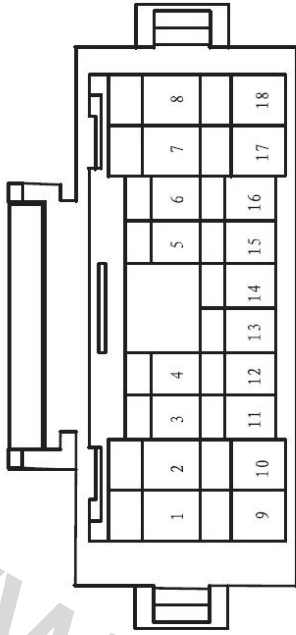

Positive power supply harness side pin definition:

- 1. Y Starter solenoid valve
- 2. R Generator S terminal
- 3. ---
- 4. ---
- 5. R Reversing switch
- 6. W Generator L terminal
- 7. G Oil Pressure switch
- 8. ---
- 9. ---
- 10. ---

- 11. ---
- 12. ---
- 13. ---
- 14. ---
- 15. B GND
- 16. ---
- 17. ---
- 18. ---

Wire harness connection (2)

FR01 Frame wire harness connects to parking radar wire harness

- 12 Female

- Frame wire harness

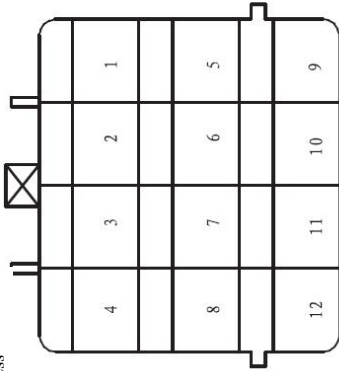

- 12 Male

- Reversing radar wireharness

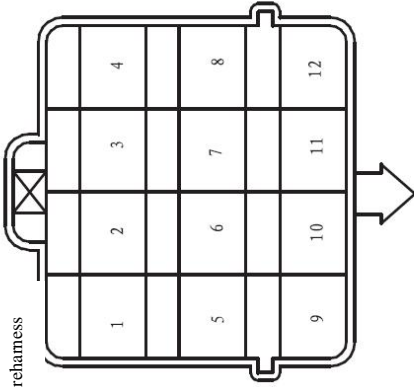

Frame wire harness side pin definition:

- | | | | |
|-------|------------------------------|--------|-----|
| 1. RW | Reversing light + | 7. -- | -- |
| 2. R | Fog lamp + | 8. B | GND |
| 3. R | Reversing radar power supply | 9. -- | -- |
| 4. L | LIN signal | 10. -- | -- |
| 5. B | GND | 11. -- | -- |
| 6. B | GND | 12. -- | -- |

Wire harness connection (4)

FD01 Frame wire harness connect to left front door wire harness

- 45 Male/Black

- Frame wire harness

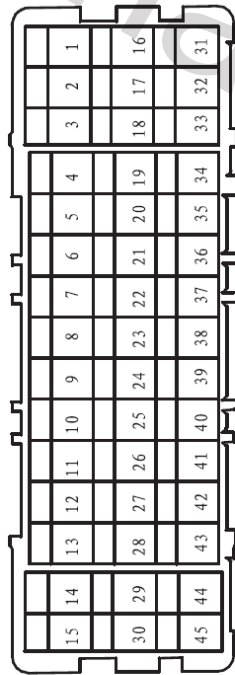

- 45 Female

- Left front door harness

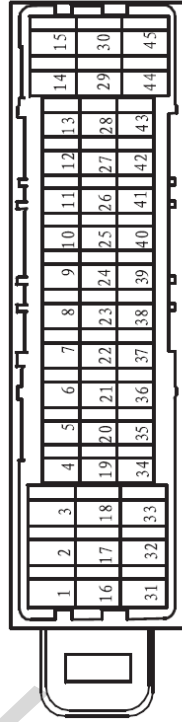

Frame wire harness side pin definition:

1. R	B+ (RH)	12. ---	---	24. ---	---	35. ---	---
2. W	B+ (LH)	13. GB	Rearview mirror UP/DOWN adjusting	25. R0	Door lock	36. ---	---
3. B	GND	14. ---	---	26. BrW	Door lock actuator	37. ---	---
4. G	Left front audio+	15. Br	Door lock actuator motor	27. ---	---	38. ---	---
5. R	Left front audio-	16. 0	Right front glass DOWN/terminal	28. LG	Rearview mirror left right adjusting +	39. ---	---
6. Y0	Small light+	17. G	Left rear glass UP terminal	29. ---	---	40. YW	Door unlock
7. B0	Small light -	18. Y	Right front glass UP terminal	30. Gr	Door lock actuator motor	41. B0	Door lock status switch
8. ---	---	19. R	Door light-	31. RG	Right front glass UP terminal	42. RY	Turning signal light
9. ---	---	20. R	Left rearview mirror defrost	32. L	Left rear glass DOWN terminal	43. GY	Rearview mirror
10. 0B	Door light-	21. ---	---	33. WR	Right rear glass DOWN terminal	44. ---	---
11. YB	Door lock actuator	22. ---	---	34. ---	---	45. ---	---
		23. ---	---				

Wire harness connection (5)

FD02

Frame wire harness connect to right front door wire harness

- 45 Male/Black

Frame wire harness

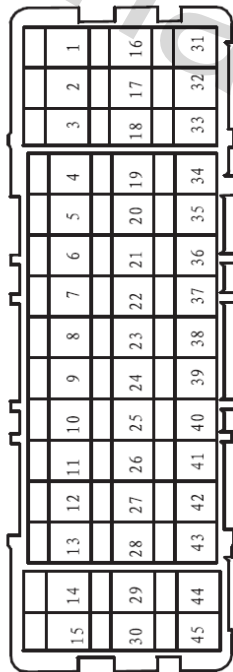

- 45 Female

Right front door wire harness

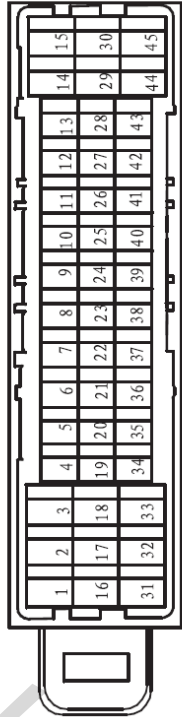

Frame wire harness side pin definition:

1.	R	B+ (RH)	12.	--	--	24.	--	--	35.	--	--
2.	--	--	13.	V	Rearview mirror UP/DOWN adjusting	25.	--	--	36.	--	--
3.	--	--	14.	--	--	26.	--	--	37.	--	--
4.	GB	Right front audio+	15.	Br	Door lock actuator motor	27.	--	--	38.	--	--
5.	RB	Right front audio-	16.	0	Right front glass DOW Nterminal	28.	P	Right rearview mirror left/right adjusting+	39.	--	--
6.	Y0	Small light+	17.	--	--	29.	--	--	40.	--	--
7.	B0	Small light-	18.	--	--	30.	Gr	Door lock actuator motor	41.	--	--
8.	--	--	19.	B	GND	31.	RG	Right front glass UP terminal	42.	RG	Turning signal light
9.	--	--	20.	R	Right rearview mirror defrost	32.	--	--	43.	OG	Rearview mirror
10.	--	--	21.	PB	Door lamp	33.	--	--	44.	--	--
11.	--	--	22.	--	--	34.	R	Door light+	45.	--	--

Wire harness connection (6)

FD03 Frame wire harness connect to rear door wire

- 1.5 Male/White

- Frame wire

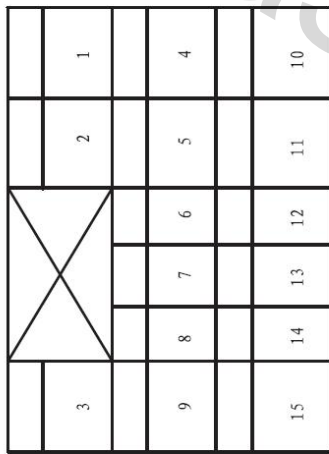

- 1.5 Female

- Rear door wire harness

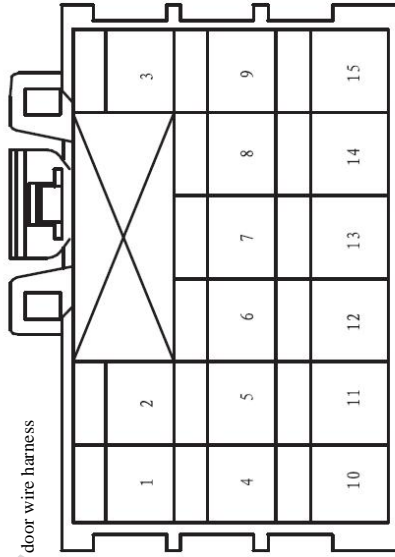

Frame wire harness side pin definition:

- 1. Br Rear audio+
- 2. W Rear audio-
- 3. --- ---
- 4. Br Rear door lock actuator
- 5. L Rear door glass lifter
- 6. Y Rear door glass UP/DOWN motor
- 7. --- ---

- 8. --- ---
- 9. --- ---
- 10. Gr Rear door lock actuator
- 11. G Rear door glass lifter
- 12. --- ---
- 13. --- ---
- 14. --- ---
- 15. --- ---

Wire harness connection (7)

EF01

Frame wire harness connects to engine wire harness

- 22 Female/black

- Frame wire harness

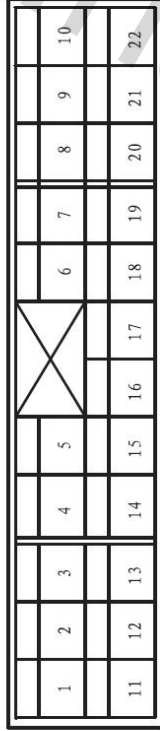

- 22 Male/Black

- Engine wire harness

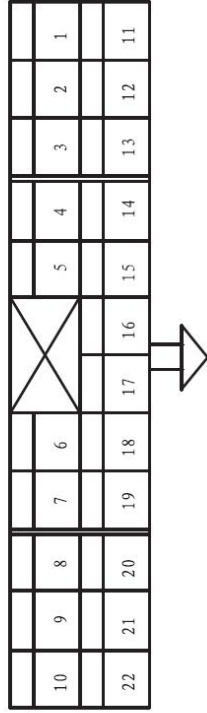

Engine wire harness side pin definition

- | | | | | |
|--------|---------------------|---------|------------------|---------|
| 1. P | Fuel pump relay | 9. GrB | Left rear power | 17. --- |
| 2. GrR | CAN cable connector | 10. RB | Left rear signal | 18. --- |
| 3. YR | CAN cable connector | 11. --- | | 19. --- |
| 4. --- | | 12. --- | | 20. --- |
| 5. --- | | 13. --- | | 21. --- |
| 6. --- | | 14. --- | | 22. --- |
| 7. GrB | Right rear signal | 15. --- | | |
| 8. GrR | Right rear power | 16. --- | | |

Wire harness connection (8)

MF01 Main wire harness connect with frame wire harness

- 24 Male/Yellow
- Main wire harness

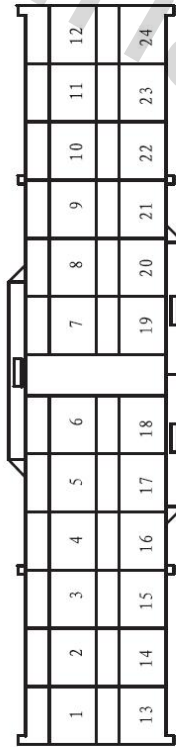

- 24 Female/yellow
- Frame harness

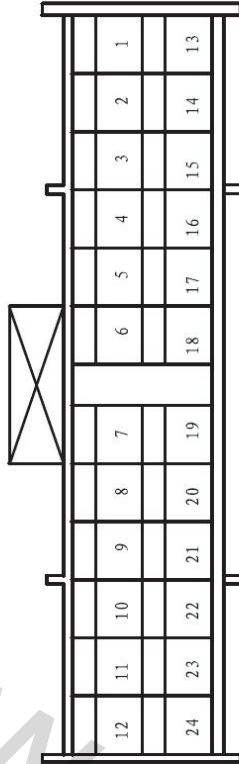

Frame wire harness side pin definition:

1. R	Rearview mirror adjust switch power	9. BrG	DAB+	17. ---	---
2. GB	Driver seat outside rear-view mirror up/down adjustment	10. BrR	DAB-	18. ---	---
3. LG	Driver seat outside rear-view mirror left-rear adjustment	11. 0	PAB+	19. ---	---
4. GY	Driver seat rear-view mirror common terminal adjustment	12. Y	PAB-	20. ---	---
5. ---	---	13. R	Grove box switch	21. YR	CAN-L
6. ---	---	14. V	Passenger seat outer rearview mirror UP/DOWN adjusting	22. GrR	CAN-H
7. ---	---	15. P	Passenger seat outer rearview mirror left /right adjustment	23. RB	Rear wiper relay
8. ---	---	16. OG	Passenger seat Rearview mirror adjusting male common terminal	24. L	Reversing radar signal

Wire harness connection (9)

MF02 Main wire harness connect with frame wire harness

- 24 Male

- Main wire harness

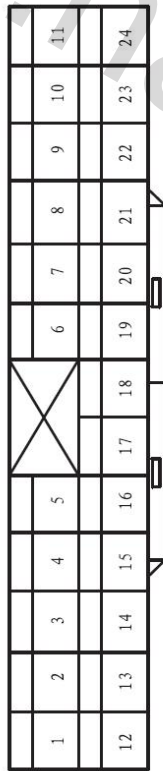

- 24 Female/grey

- Frame wire harness

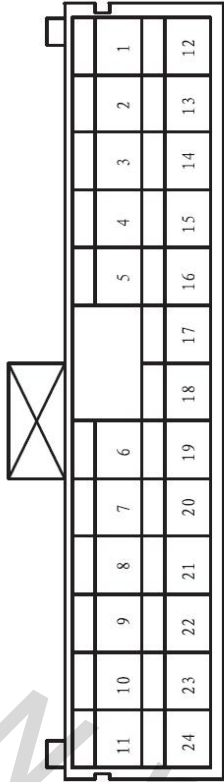

Frame wire harness side pin definition:

1. ---	9. R	17. L0	Fuel pump sensor +
2. ---	10. G	18. ---	---
3. R	Cigarette lighter lighting ring +	19. ---	---
4. RY	Left turning lamp +	20. ---	---
5. R	Rear fog lamp +	21. ---	---
6. ---	---	22. ---	---
7. L	TyreFault	23. ---	---
8. 0	TyreError	24. ---	---
			Rear wiper power
			Rear wiper reset switch
			Rear wiper switch
			High-mounted brake lamp power
			Brake lamp +
			Left Turning signal light +
			Fuel pump sensor -

Wire harness connection (10)

MF03 Main wire harness connect with frame wire harness

- 22 Male/Blue

- Main wire harness

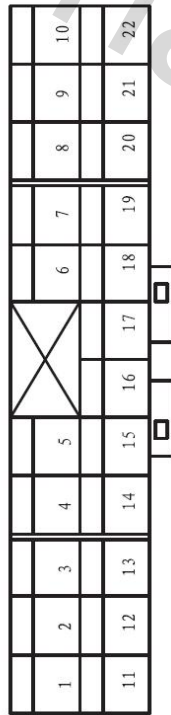

- 22 Female/blue

- Frame wire harness

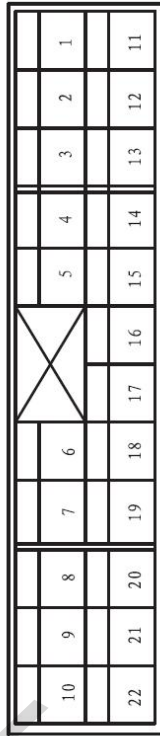

Frame wire harness side pin definition:

1. G	Right rear audio+	9. --	--
2. GB	Right front audio+	10. --	--
3. G	Left front audio+	11. 0	
4. Br	Left rear audio+	12. RB	
5. --	--	13. R	
6. R	Backup radar sensor power	14. W	
7. R	Right front door light +	15. --	--
8. Y0	Small light+	16. --	--
		17. --	--
		18. --	--
	Right rear audio-	19. --	--
	Right front audio-	20. B0	Small light -
	Left front audio-	21. --	--
	Left rear audio-	22. --	--

Wire harness connection (11)

MR01 Main wire harness connect with ceiling wireharness

- 22 Male

- Main wire harness

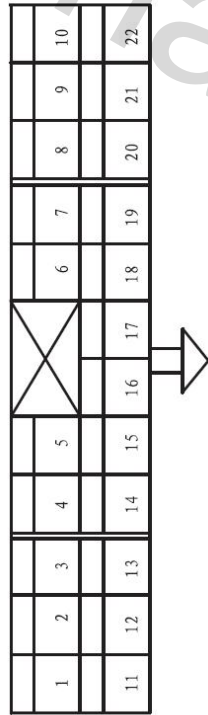

- 22 Female

- Ceiling wire harness

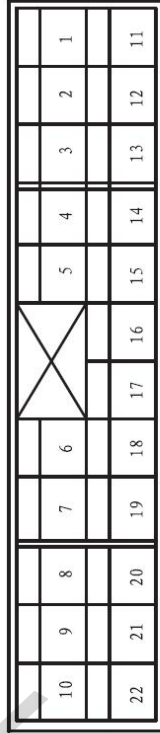

Ceiling wire harness side pin definition:

- 1. — —
- 2. — —
- 3. — —
- 4. RGr Interior rearview mirror power
- 5. 0 Reversing signal
- 6. B GND
- 7. R Sunroof controller power supply B+
- 8. R Ceiling light, sunvisor power
- 9. Br Ceiling light center control
- 10. RGr Sunroof controller power supply IG2
- 11. — —
- 12. — —
- 13. — —
- 14. — —
- 15. — —
- 16. — —
- 17. — —
- 18. — —
- 19. — —
- 20. — —
- 21. — —
- 22. — —

Wire harness connection (12)

ME01 Main harness connect with engine harness

- 24 Male/White

- Main wire harness

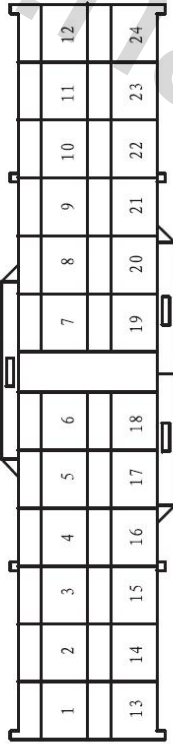

- 24 Female/White

- Engine wire harness

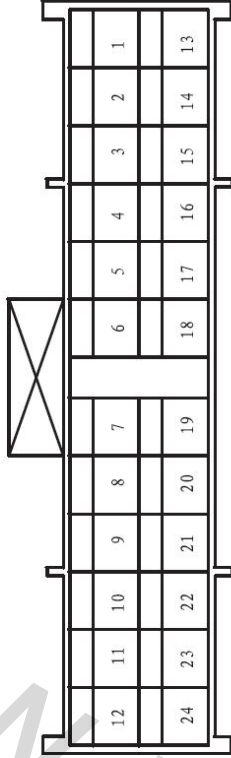

Engine wire harness side pin definition:

1. -- --	9. W	17. P	Right front combination lamp
2. -- --	10. RO	18. L	Electric adjusting control
3. V ESC Switch	11. R	19. -- --	
4. Y HDC Switch	12. Gr	20. -- --	
5. Br K wire	13. -- --	21. -- --	
6. Y0 Blower signal	14. -- --	22. -- --	
7. -- --	15. W	23. L	Three-way pressure switch
8. -- --	16. -- --	24. -- --	

Wire harness connection (13)

ME02 Main wire harness connect with engine wire harness

-- 15 Male

-- Main wire harness

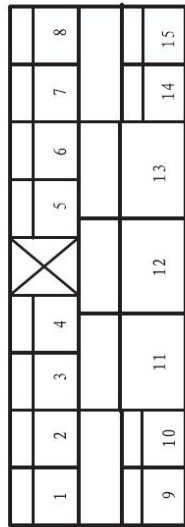

-- 15 Female

-- Engine wire harness

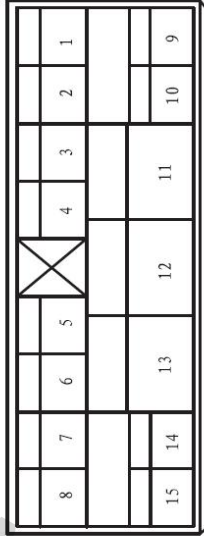

Engine wire harness side pin definition:

- 1. ---
- 2. ---
- 3. ---
- 4. ---
- 5. ---
- 6. ---
- 7. ---
- 8. ---
- 9. ---
- 10. ---
- 11. R Start relay
- 12. R B+
- 13. RW Blower relay
- 14. ---
- 15. ---

Wire harness connection (14)

ME03 Main wire harness connect with engine wire harness

- 15 Male

- Main wire harness

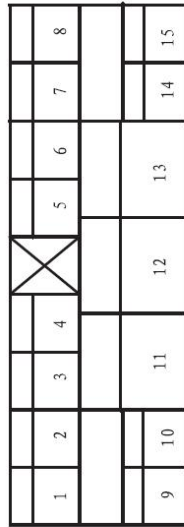

- 15 Female

- Engine wire harness

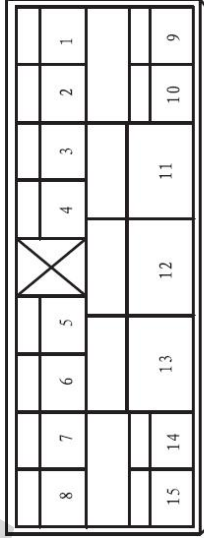

Engine wire harness side pin definition:

- 1. ---
- 2. ---
- 3. ---
- 4. G Oil pressure signal
- 5. Br Front wiper high speed relay
- 6. Gr Front wiper low speed relay
- 7. L Front wiper returning
- 8. ---

- 9. ---
- 10. ---
- 11. 0 Front washing pump switch
- 12. L Rear washing pump switch
- 13. ---
- 14. ---
- 15. ---

Wire harness connection (15)

ME04 Main wire harness connect with engine wire harness

- 2 Male/Black

- Main wire harness

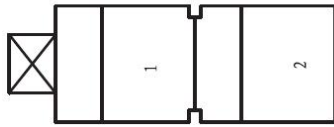

- 2 Female/black
- Engine wire harness

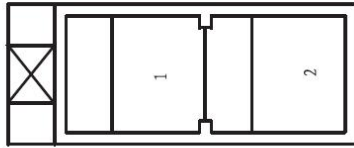

Engine wire harness side pin definition:

1. R Main wire harness

2. B GND

Indoor terminal box (1)

I/P-A Indoor terminal box
 - 18 Female

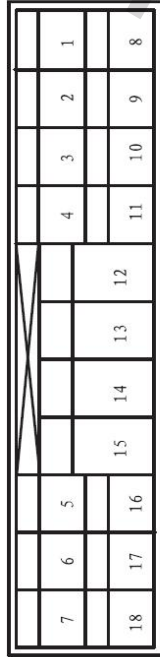
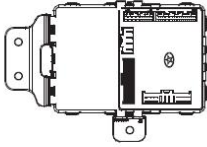

- 1. RGr Rear washing power 13. ---
- 2. RGr Front wiper power 14. W Rear deforst power supply
- 3. --- 15. ---
- 4. --- 16. ---
- 5. --- 17. R Left front fog lamp power
- 6. --- 18. Y Left front low beam power
- 7. ---
- 8. LR Right front low beam power
- 9. 0 Left front high beam power
- 10. R Right front fog lamp power
- 11. P Right front high beam power supply
- 12. RBr IG1

I/P-B Indoor terminal box
 - 4 Female

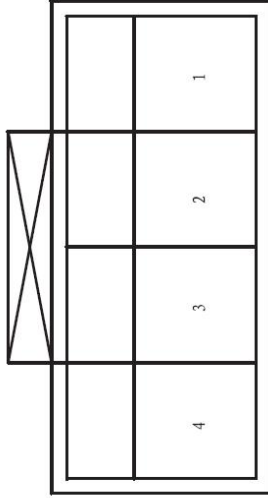
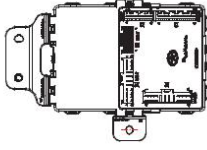

- 1. R B+
- 2. R B+
- 3. R B+
- 4. R B+

Indoor terminal box (2)

I/P-C Indoor terminal box
- 28 Female

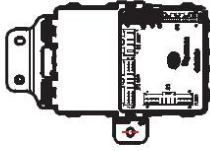

14	13	12	11	10	9	8	7	6	5	4	3	2	1
28	27	26	25	24	23	22	21	20	19	18	17	16	15

- 1. --
- 2. --
- 3. --
- 4. --
- 5. --
- 6. --
- 7. W Charging indicator light
- 8. RGr Blower relay
- 9. --
- 10. --
- 11. --
- 12. --

- 13. Gr Electric horn power
- 14. L Rear defrost power
- 15. V Clutch pedal 2 power
- 16. --
- 17. --
- 18. --
- 19. --
- 20. --
- 21. --
- 22. R Backup switch power
- 23. Y Brake fluid sensor +
- 24. P Brake switch power
- 25. LY Right front position light power
- 26. L0 Left front position light power
- 27. --
- 28. -- Deicing relay control

Indoor terminal box (3)

I/P=D Indoor terminal box
 - 40 Female/White

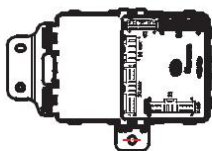

20	19	18	17	16	15	14	13	12	11	10	9	8	7	6	5	4	3	2	1
40	39	38	37	36	35	34	33	32	31	30	29	28	27	26	25	24	23	22	21

- 1. R Right rear position light+
- 2. W Left rear position light +
- 3. --- ---
- 4. --- ---
- 5. --- ---
- 6. --- ---
- 7. --- ---
- 8. --- ---
- 9. --- ---
- 10. R Trunk light power
- 11. R Grove box switch
- 12. RB Airbag ECU power IGI
- 13. R Rearview mirror adjust switch power
- 14. --- ---
- 15. R/B Tire pressure monitoring
- 16. --- ---
- 17. Gr Driver's seat seat belt switch +
- 18. --- ---
- 19. L Left rear door contact switch +
- 20. Y Hand brake switch

- 21. --- --- Rear wiper relay
- 22. --- --- Left front door contact switch +
- 23. RB Right front door contact switch +
- 24. 0 Right rear door contact switch +
- 25. W Left front door lock actuator
- 26. P Left front door lock status switch
- 27. --- ---
- 28. YB Left front door lock actuator
- 29. --- ---
- 30. --- ---
- 31. B0 Left front door lock status switch
- 32. --- ---
- 33. --- ---
- 34. BfW Left front door lock actuator
- 35. Y Tailgate switch
- 36. R0 Left front door lock
- 37. YW Door unlock
- 38. --- ---
- 39. P Rear trunk lid spring lock
- 40. --- ---

Indoor terminal box (4)

1/P-E Indoor terminal box

- 20 Female/White

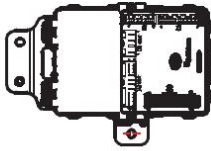

8	7	6	5	4	3	2	1				
20	19	18	17	16	15	14	13	12	11	10	9

1. RW Reversing light+

2. — —

3. — Right outer rearview mirror power

4. — —

5. B GND

6. W B+(LH)

7. Y Right rear door glass UP/DOWN switch

8. Gr Right front door lock actuator motor

9. Br Right front door lock actuator motor

10. Br Rear trunk lid spring lock

11. — Left outer rearview mirror power

12. R Rear wiper motor power

13. — —

14. R Rear defroster power

15. — —

16. — —

17. — —

18. G Left rear glass UP/DOWN motor

19. R B+(RH)

20. — —

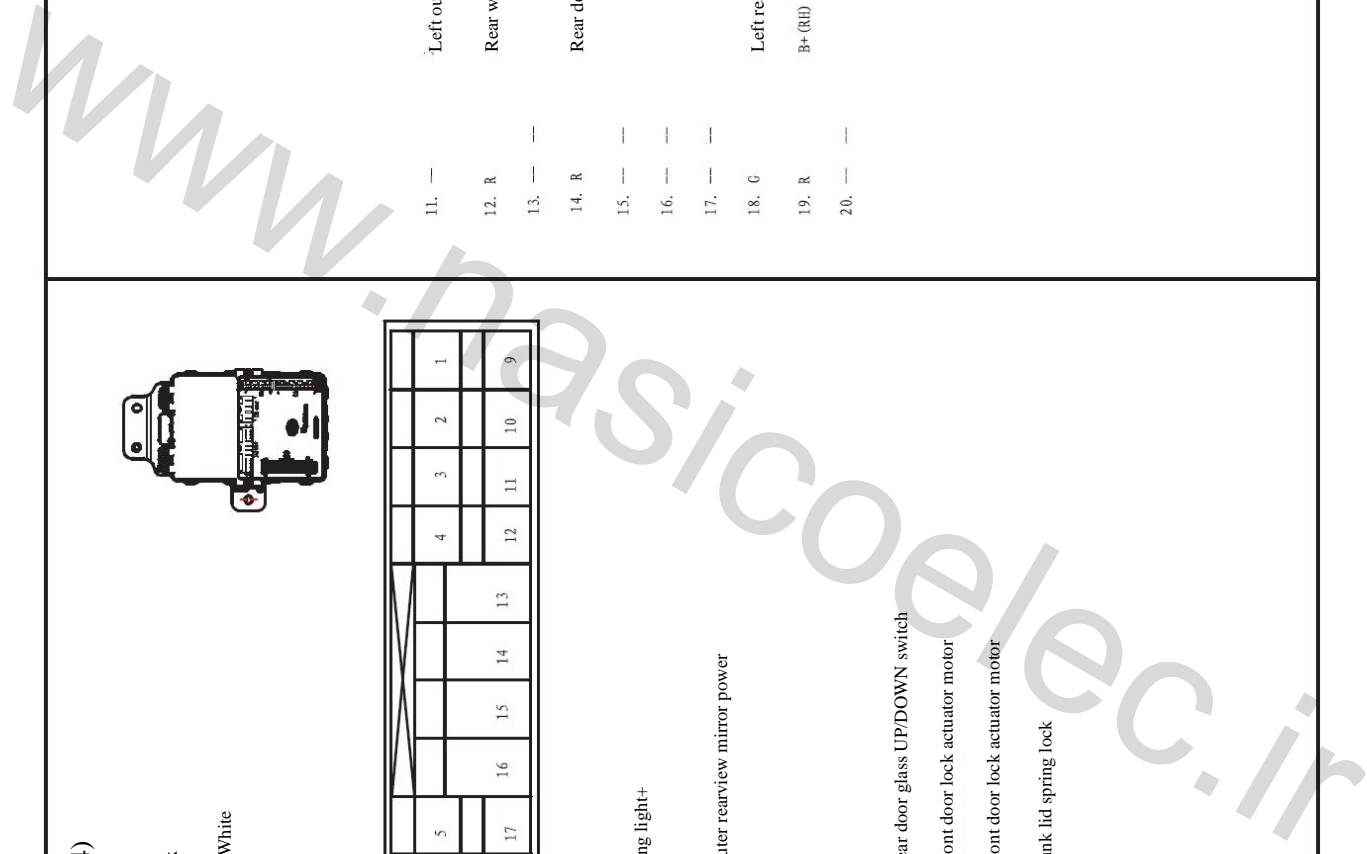

Indoor terminal box (5)

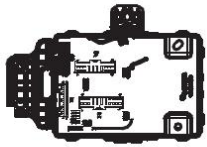

I/P-F Indoor terminal box
- 28 Female/

14	13	12	11	10	9	8	7	6	5	4	3	2	1
28	27	26	25	24	23	22	21	20	19	18	17	16	15

- 1. --
- 2. --
- 3. --
- 4. --
- 5. --
- 6. --
- 7. W Charging indicator
- 8. RGr Blower relay
- 9. G Low beam light switch
- 10. --
- 11. --
- 12. RGr Sunroof controller power supply IG2

BCM power IG2

- 13. RGr
- 14. --
- 15. --
- 16. --
- 17. --
- 18. --
- 19. --
- 20. --
- 21. --
- 22. --
- 23. --
- 24. Y Rear defrost working lamp
- 25. Y0 A/C controller small light+
- 26. --
- 27. --
- 28. --

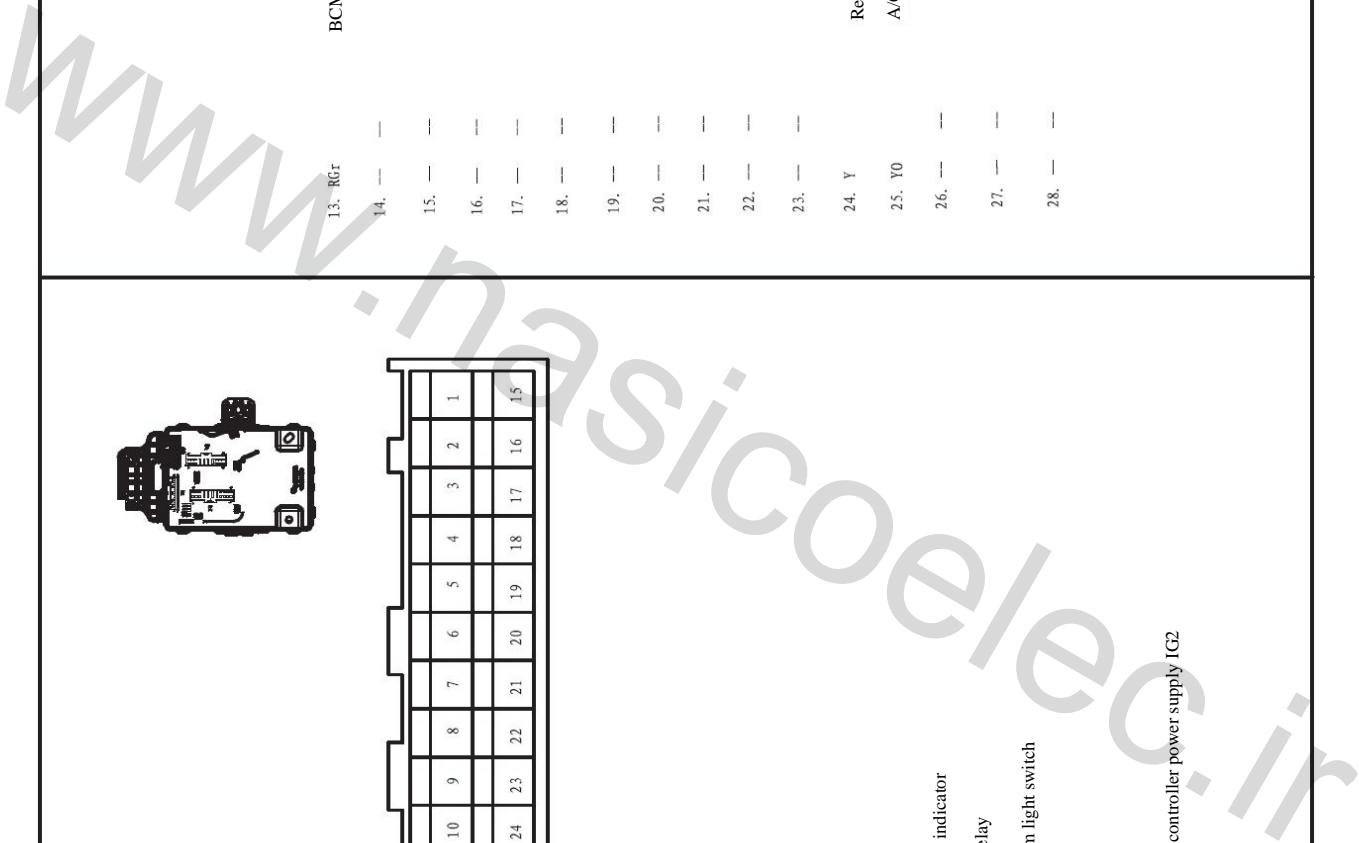

Indoor terminal box (6)

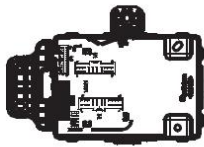

I/P-G Indoor terminal box
- 32 Female

16	15	14	13	12	11	10	9	8	7	6	5	4	3	2	1
32	31	30	29	28	27	26	25	24	23	22	21	20	19	18	17

- 1. -- --
- 2. RBr Instrument IG1 power
- 3. -- --
- 4. -- --
- 5. -- --
- 6. -- --
- 7. -- --
- 8. V Charging indicator
- 9. RBr ESC switch
- 10. -- --
- 11. -- --
- 12. -- --

- 13. 0 Reversing signal
- 14. -- --
- 15. -- --
- 16. RGr BCM power ACC
- 17. -- --
- 18. -- --
- 19. -- --
- 20. -- --
- 21. -- --
- 22. -- --
- 23. -- --
- 24. L BCM
- 25. -- --
- 26. RBr EPS power IG1
- 27. RBr A/C controller IG1 power
- 28. -- --
- 29. R Reversing radar
- 30. -- --
- 31. RGr CD player ACC power
- 32. -- --

Indoor terminal box (7)

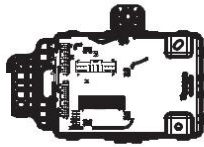

1/P-H Indoor terminal box
- 18 Female

7	6	5	4	3	2	1
18	17	16	15	14	13	12
						11
						10
						9
						8

- 1. Br CAN-H 11. ---
- 2. R BCM power B+ 12. ---
- 3. RBr BCM power IG1 13. ---
- 4. --- 14. W Ignition switch IG1 power
- 5. RGr On-board power-supply system+ 15. ---
- 6. --- 16. G BCM power B+
- 7. R Rear fog lamp power 17. R Diagnosis interface, Ceiling power
- 8. W CAN-L 18. RGr Interior rearview mirror power IG2
- 9. ---
- 10. B GND

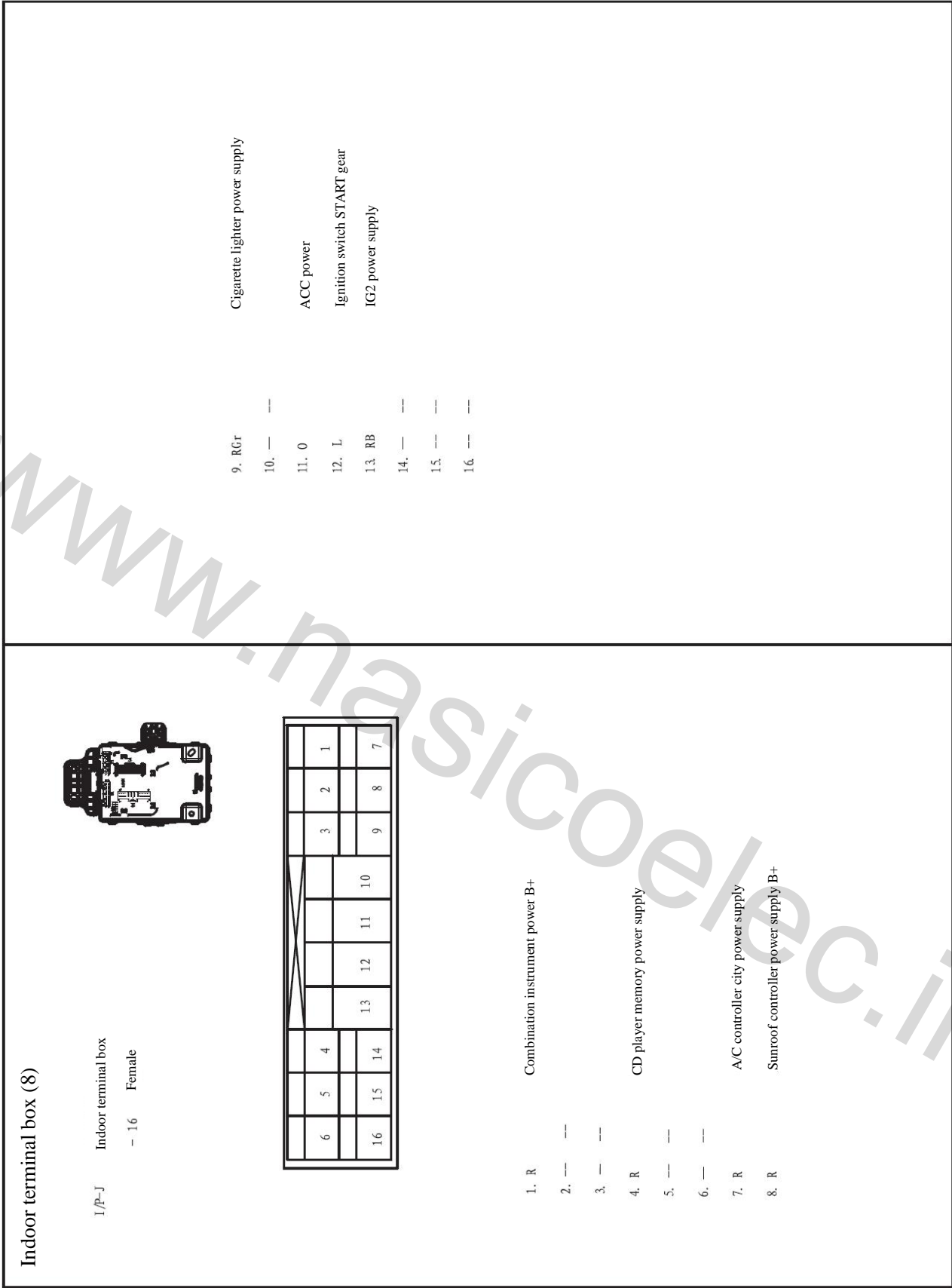

www.nasircoelec.ir

Indoor assistant-terminal box (1)

Indoor assistant-terminal box A

- 20 Female

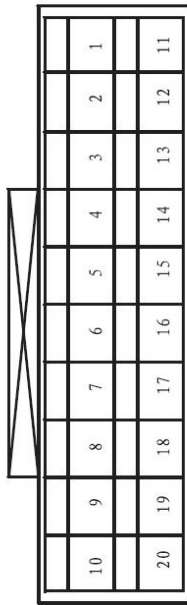

- | | | | |
|--------|-------------------------|--------|------------------------------|
| 1. G | Rear wiper reset switch | 11. R | Rear wiper power B+ |
| 2. RB | Rear wiper relay | 12. L | Connect to rear wiper switch |
| 3. -- | -- | 13. R | Rear fog lamp relay |
| 4. L | Rear fog lamp relay | 14. R | Rear fog lamp power |
| 5. -- | -- | 15. -- | -- |
| 6. -- | -- | 16. -- | -- |
| 7. -- | -- | 17. -- | -- |
| 8. -- | -- | 18. -- | -- |
| 9. -- | -- | 19. -- | -- |
| 10. -- | -- | 20. -- | -- |

Indoor assistant-terminal box B

- 16 Female

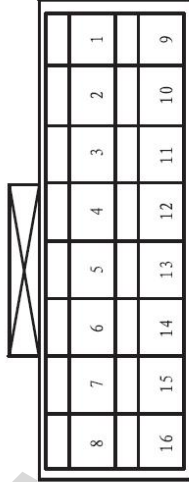

- | | | | |
|-------|------------------------|--------|------------------------|
| 1. -- | -- | 9. -- | -- |
| 2. -- | -- | 10. -- | -- |
| 3. -- | -- | 11. -- | Flashing relay power |
| 4. R | Flashing relay power | 12. -- | Flashing relay control |
| 5. Br | Flashing relay control | 13. -- | -- |
| 6. -- | -- | 14. -- | -- |
| 7. -- | -- | 15. -- | -- |
| 8. -- | -- | 16. -- | -- |

Control wire harness (1)

CC01 Injector wire harness Engine main wire harness

- 12 Female

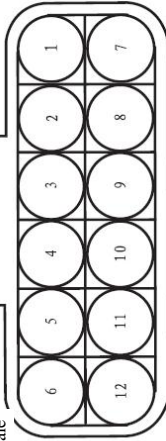

- | | | | |
|--------|-----------------|--------|--|
| 1. L/Y | Injector 1 | 7. Y | Ignition coil 2 |
| 2. L/G | Injector 2 | 8. R | IRC2 B+ |
| 3. L/W | Injector 3 | 9. B | GND |
| 4. L/B | Injector 4 | 10. R | Crankshaft position sensor high signal |
| 5. Y/G | IRC1 B+ | 11. Gr | Crankshaft position sensor low signal |
| 6. W | Ignition coil 1 | 12. L | Carbon canister solenoid valve |

CI2 Knock sensor

- 2 Female

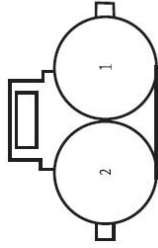

- | | |
|------|-------------|
| 1. Y | Signal low |
| 2. L | Signal high |

CI 3 Camshaft position sensor

- 3 Male

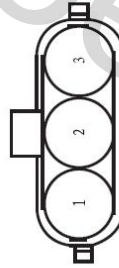

- | | |
|--------|--------------------------|
| 1. B/G | Camshaft position sensor |
| 2. G | 5V- |
| 3. R/G | 5V+ |

C01 Front oxygen sensor

- 4 Male

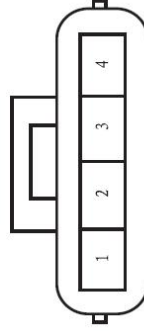

- | | |
|--------|-----------------|
| 1. B/W | 5V- |
| 2. L/W | Signal |
| 3. G/W | Heating control |
| 4. L | IRC1 B+ |

Control wire harness (3)

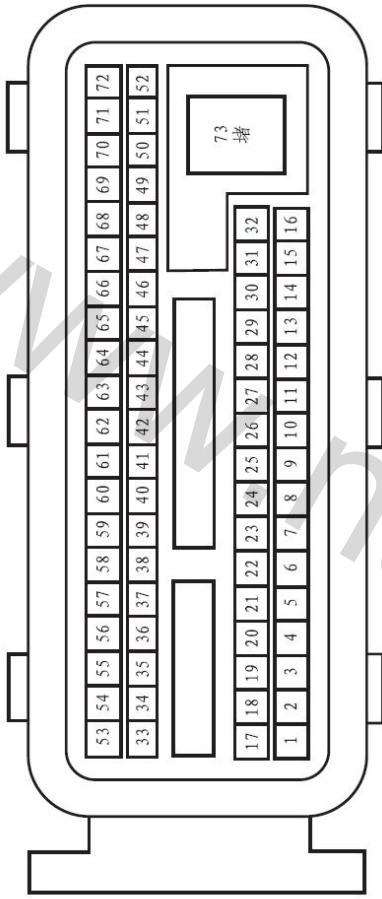

ECU-E ECU module

- 73 Female (grey)

1. W	Ignition coil driver	13. ---	25. ---	36. ---	48. ---	60. ---
2. B/W	5V grounding #1	14. G/W	26. L	37. ---	49. ---	61. R/W Throttle motor
3. B/W	5V grounding #	15. G	27. Br	38. ---	50. ---	62. ---
4. R/W	5V reference voltage #1	16. ---	28. Y	39. G	51. ---	63. L/W 2 Cylinder fuel injector
5. ---	Ignition coil driver	17. L	29. G	40. ---	52. ---	64. W/L 3 Cylinder fuel injector
6. R/G	5V reference voltage #2	18. G	30. ---	41. L/W	53. ---	65. L 1 Cylinder fuel injector
7. Lg	5V reference voltage #2	19. R/B	31. R	42. ---	54. ---	66. W/L 4 Cylinder fuel injector
8. ---	Manifold air intake temperature sensor	20. Gr	32. ---	43. R	55. ---	67. B/W Throttle valve motor high
9. Y	Front oxygen sensor	21. R	33. ---	44. ---	56. B/G	68. ---
10. L/W	5V reference voltage #2	22. ---	34. P	45. G	57. L	69. ---
11. ---	Knock sensor	23. R/G	35. ---	46. ---	58. ---	70. ---
12. L	Knock sensor	24. B/W	35. ---	47. ---	59. ---	71. ---
						72. ---
						73. ---

Control wire harness (4)

C18 Brake vacuum pressure sensor

- 3 Male

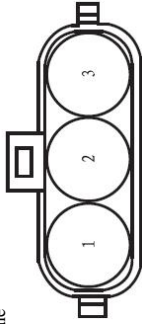

1. B/Y 5V+
2. B/W 5V-
3. W Vacuum pressure sensor

C14 Boosting pressure sensor (at behind of throttle valve)

- 3 Female

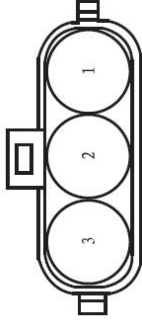

1. L/G 5V reference voltage #2
2. Br/W Air intake manifold pressure sensor
3. P 5V ground wire #2

C10 Electric throttle valve body

- 8 Female

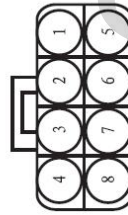

1. B/W 5V ground wire #
2. G Throttle valve position sensor #2
3. L Throttle valve position sensor #1
4. R/W 5V reference voltage #1
5. B/W Throttle motor high
6. ---
7. ---
8. R/W Throttle motor

C15 Temperature pressure sensor

- 4 Male

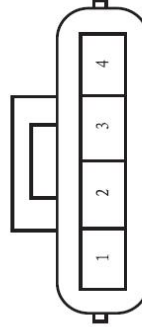

1. R/B 5V ground wire #2
2. R Boosting air intake temperature
3. R/G 5V reference voltage #2
4. L/W Boosting air intake pressure

Control wire harness (5)

C21 Drain control valve

- 2 Female

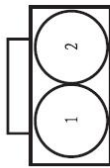

- 1. W IRC1
- 2. G Variable induction system (supercharge)

C11 Water temperature sensor

- 3 Male



- 1. G Cooling water temperature sensor
- 2. -- --
- 3. B/W 5V ground wire #2

C20 Boosting pressure control valve

- 2 Male



- 1. R Turbo charging
- 2. R IRC1

C02 Rear oxygen sensor

- 4 Female

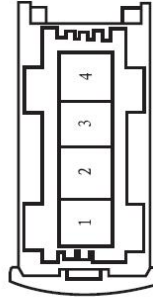

- 1. G/W GND
- 2. G/R Rear oxygen sensor
- 3. R/W Rear oxygen heating control
- 4. R IRC1

Control wire harness (6)

C17

Air intake temperature pressure sensor

- 4 Male

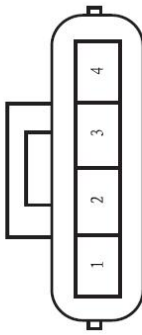

1. B/W 5V-

2. Y Manifold air intake temperature sensor

3. B/Y 5V+

4. G Atmospheric pressure signal input

C09

Ignition coil B

- 2 Male



1. W/R IRC2

2. Y Ignition coil driver

C08

Ignition coil A

- 2 Male

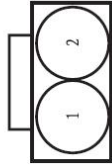

1. W/B IRC2

2. Br Ignition coil driver

Wire Harness Layout

Main Wire Harness	HL-2
A/C Wire Harness	HL-4
Frame Wire Harness	HL-5
Ceiling Wire Harness	HL-7
Left Front Door Wire Harness	HL-8
Right Front Door Wire Harness	HL-9
Left Back Door Wire Harness	HL-10
Right Back Door Wire Harness	HL-11
Tailgate Wire Harness	HL-12
Engine Wire Harness	HL-13

www.nasicoelec.ir

Main Wire Harness

Main Wire Harness (1)

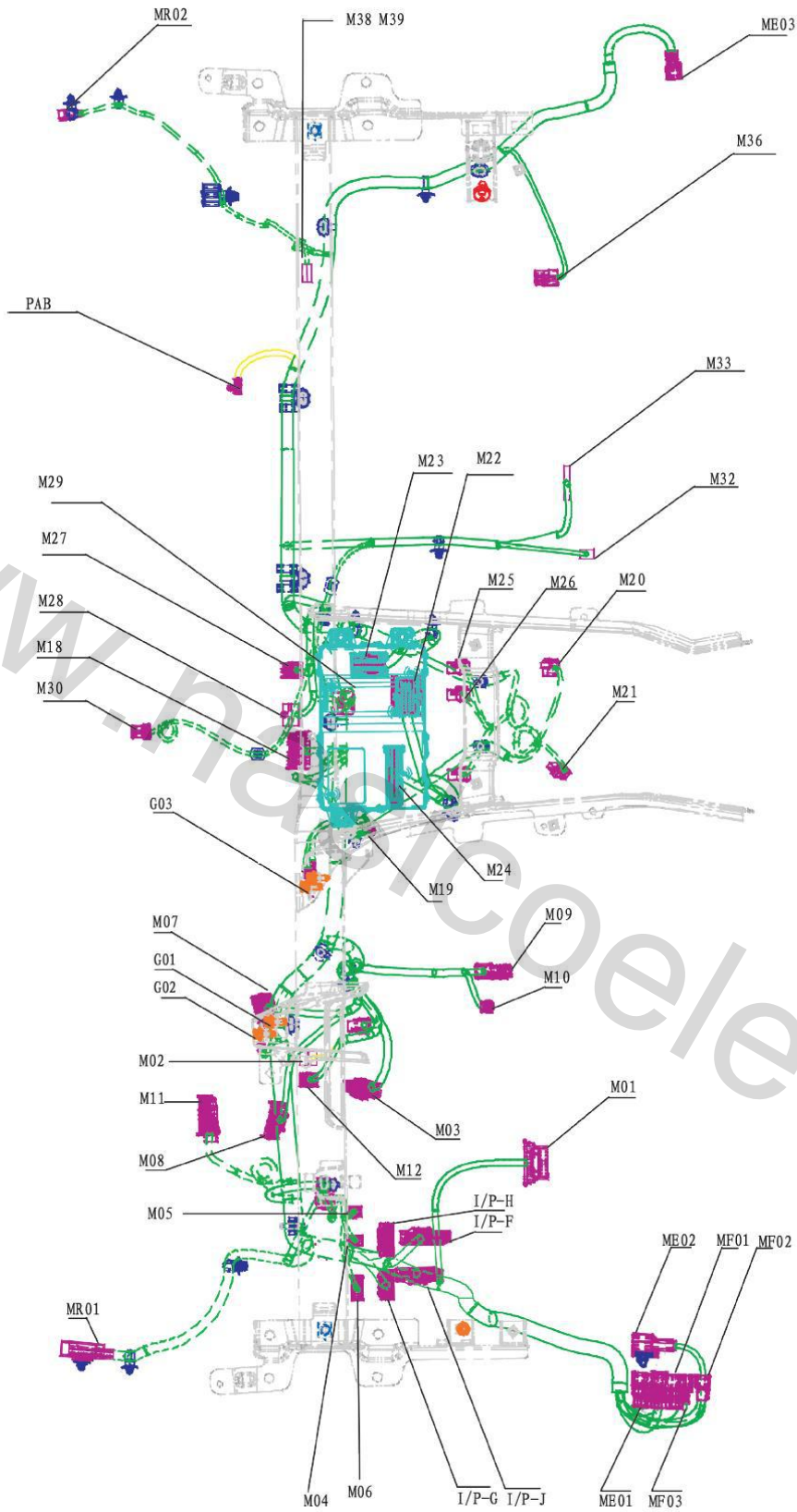

Main Wire Harness (2)	
M38 M39	Connect to glove box headlamp
ME03	Connect to engine wire harness interface 3
M36	Connect to blower motor
M33	Connect to speed regulation resistance
M32	Connect to evaporator temperature sensor
M27	Connect to A/C controller 2
M28	Connect to A/C controller 1
M30	Connect to lighting sensor
M23	Connect to BCM 2
M22	Connect to BCM 1
M09	Connect to ESP switch
M10	HDC switch
M20	Connect to cigarette lighter
M21	Connect to on-board power-supply system
M18	CD player
M29	Connect to hazard warning light switch
M24	Connect to BCM3
M19	Connect to reversing radar buzzer
M07	Connect to combination switch (lighting)
M25	Connect to EPS motor
M26	Connect to EPS connector
M03	Connect to ignition lock
M12	Connect to helical cable 1
M02	Connect to helical cable 2
M11	Connect to combination instrument connector
M08	Connect to combination switch (wiper)
M01	Diagnostic interface
M06	Connect to rearview mirror adjusting switch
M04	Connect to lighting adjusting switch
M05	Connect to headlamp adjusting switch
MF01	Connect to frame wire harness interface 1
MF02	Connect to frame wire harness interface 2
MF03	Connect to frame wire harness interface 3
ME01	Connect to engine front compartment interface 1
ME02	Connect to engine front compartment interface 1
ME03	Connect to engine front compartment interface 1
MR01	Connect to ceiling wire harness 1
MR02	Connect to ceiling wire harness 2

A/C Wire Harness

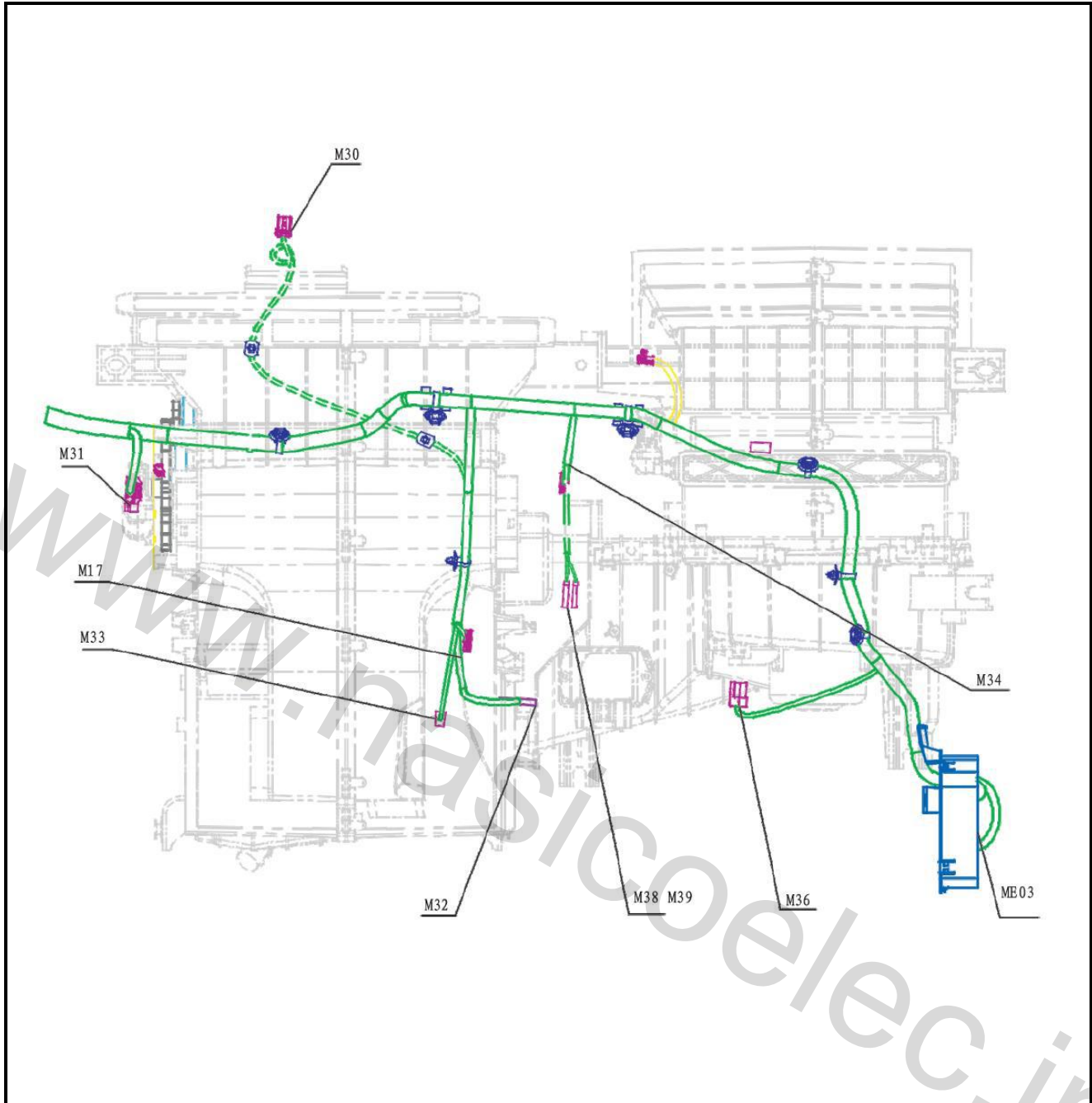

M32	Speed regulation module
M38 M39	Grove box headlamp
M36	Blower
M34	Inside and outside circular air door motor
M33	Evaporator temperature sensor
M17	Mode air door motor
M31	Cooling/heating air door motor
M30	Lighting sensor
ME03	Connect to engine wire harness 3

Frame Wire Harness

Frame wire harness (1)

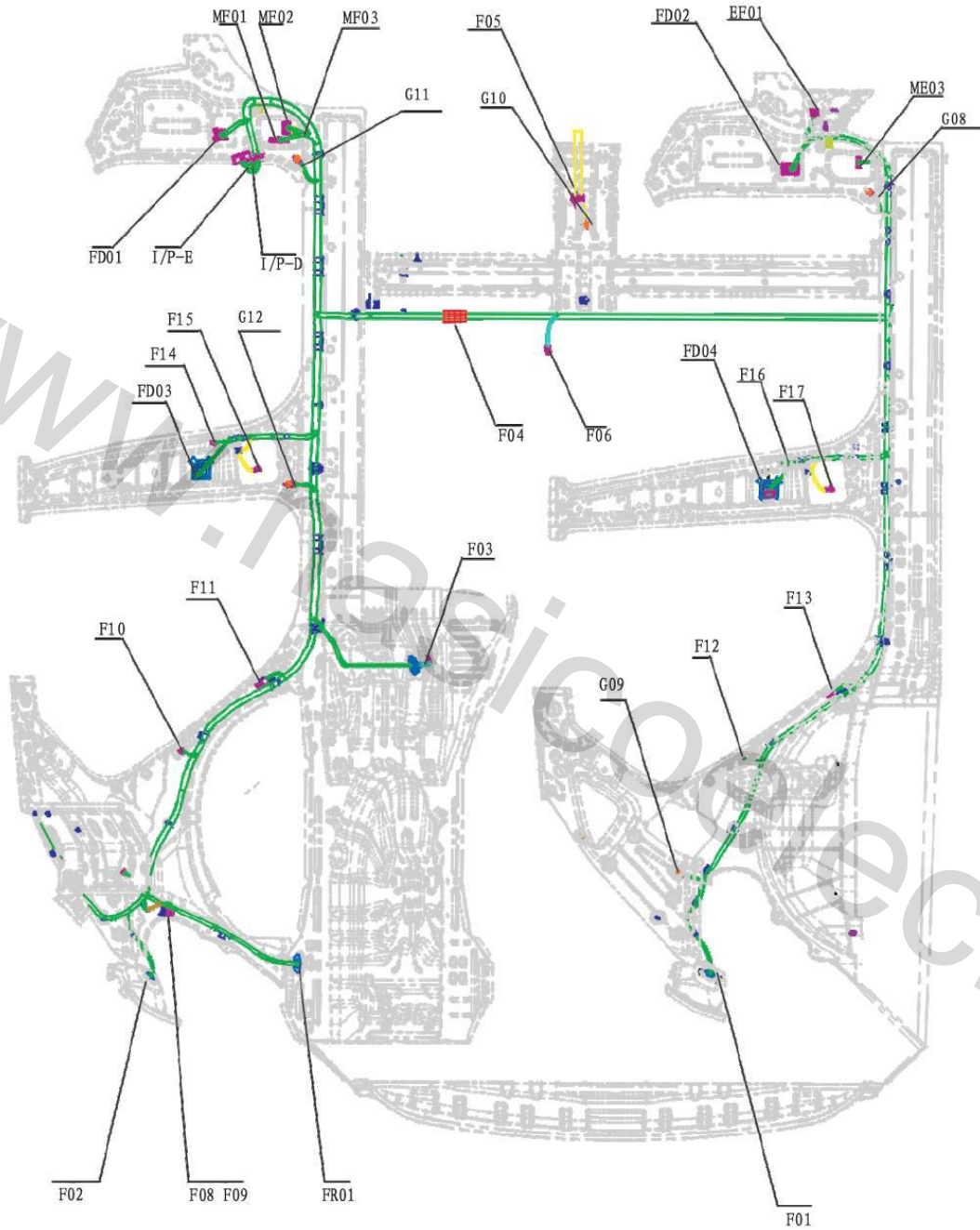

Ceiling Wire Harness



R02	Front ceiling light
R01	Rear ceiling light
R03	Connect to left sunvisor connector
R04	Connect to right sunvisor connector
MR01	Connect to instrument wire harness connector

Left Front Door Wire Harness

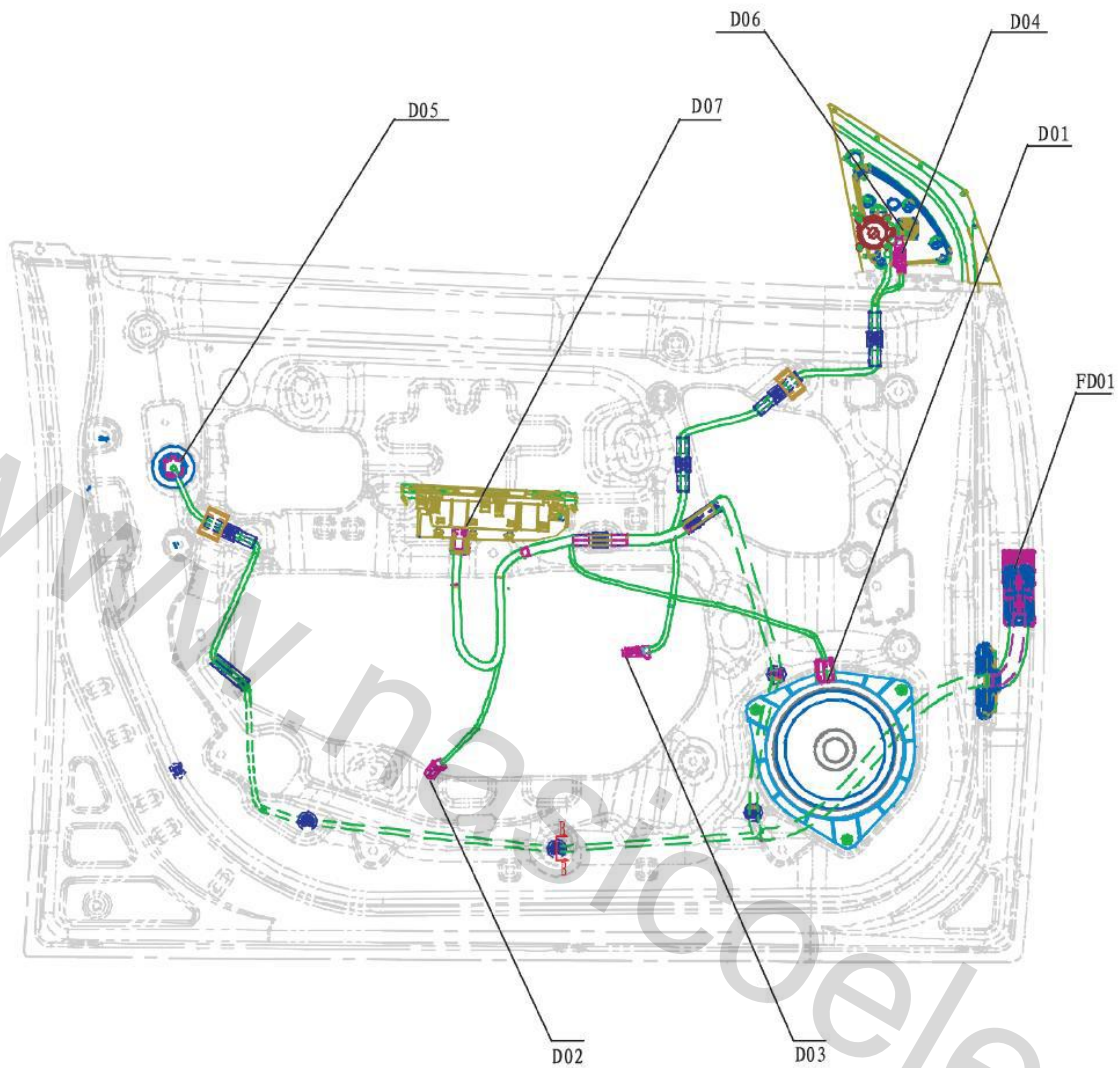

D06	Front door rearview mirror
D04	Front door speaker
D05	Front door lock motor
FD01	Connect to frame wire harness connector
D01	Front door speaker
D07	Front door glass UP/DOWN switch
D02	Front door lamp
D03	Front door glass UP/DOWN motor

Right Front Door Wire Harness

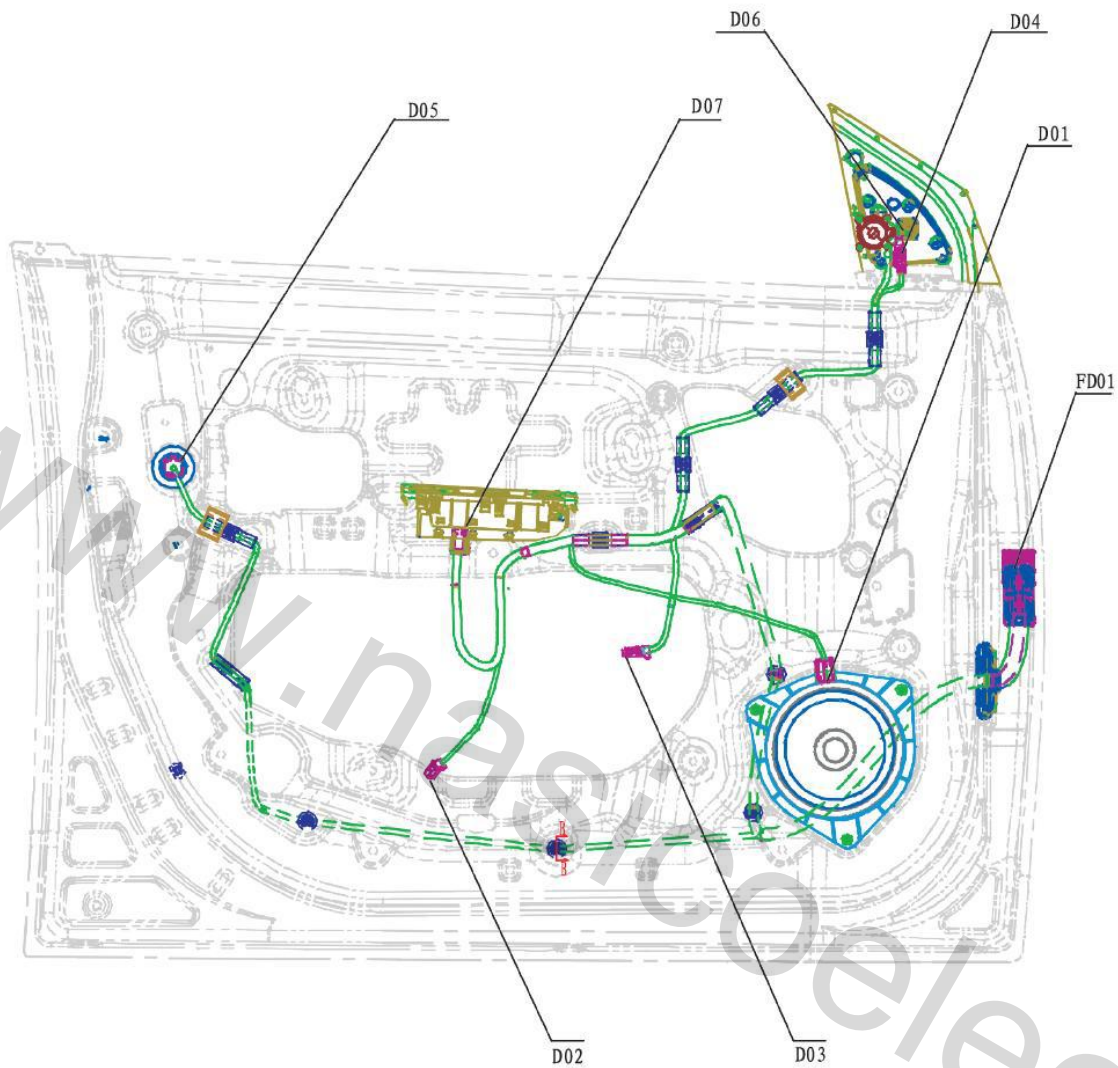

D13	Right front door rearview mirror
D11	Right front door speaker
D14	Right front door glass UP/DOWN switch
D12	Right front door lock motor
FD02	Connect to frame wire harness connector
D08	Right front door speaker
D09	Right front door lamp
D10	Right front door glass UP/DOWN motor

Left Back Door Wire Harness

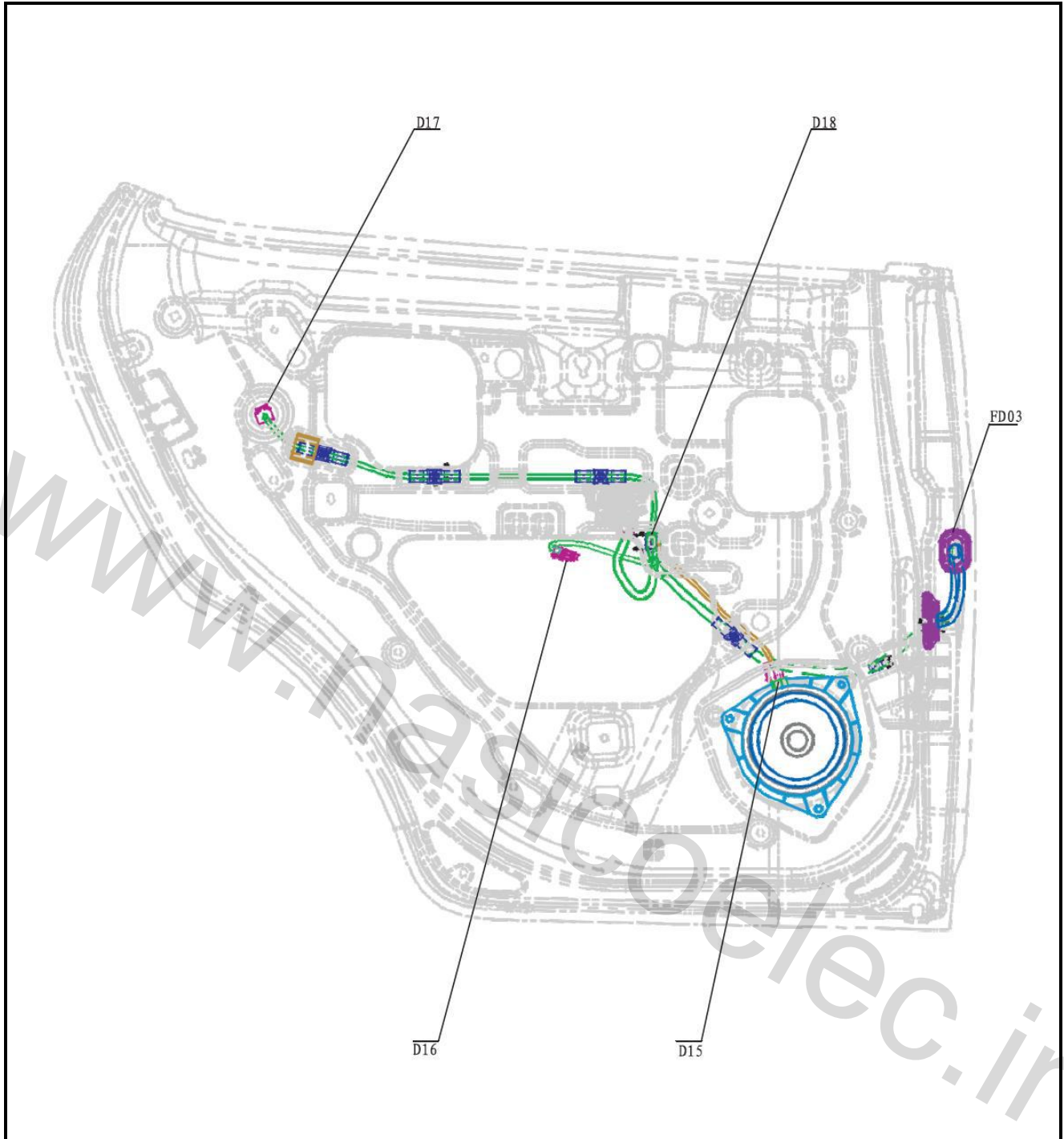

D16	Left rear glass UP/DOWN motor
D18	Left rear glass UP/DOWN motor
D17	Left rear lock motor
D15	Left rear speaker
FD03	Frame wire harness Connect to connector

Right back door wire harness

D19	Right rear speaker
D20	Right rear glass lifter
D21	Right rear lock motor
D22	Right rear glass UP/DOWN switch
FD04	Frame wire harness Connect to connector

www.nasicoelec.ir

Tailgate wire harness

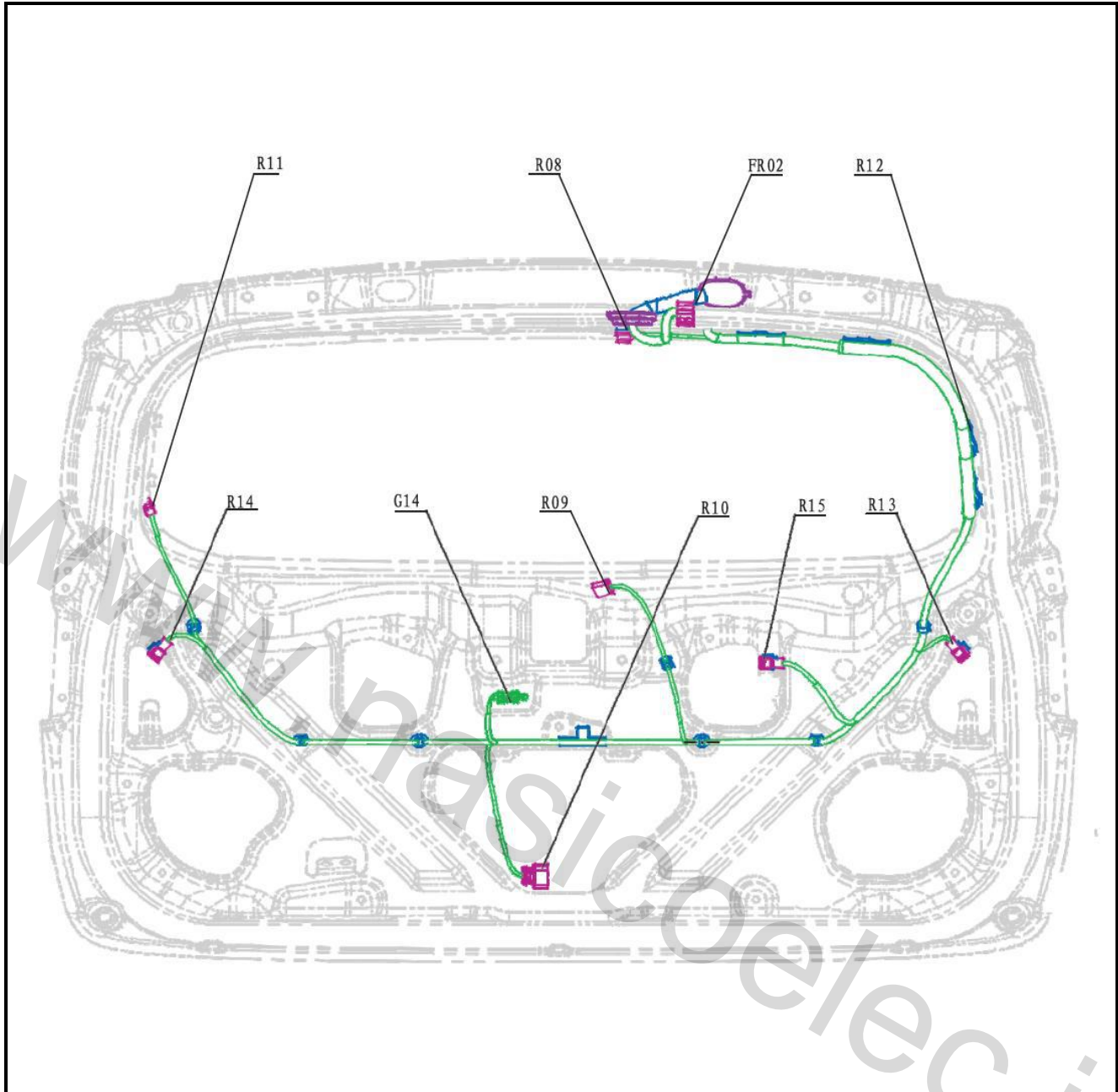

R08	High-mounted brake lamp connector
FR02	Connect to frame wire harness connector
R11	Defrost power +
R12	Defrost power —
R13	Left rear inside tailing lamp
R14	Right rear inside tailing lamp
R15	Connect to tailgate switch wire harness connector
R09	Rear wiper motor connector
R10	Fastener motor connector

Engine Compartment Wire Harness

Engine compartment wire harness (1)

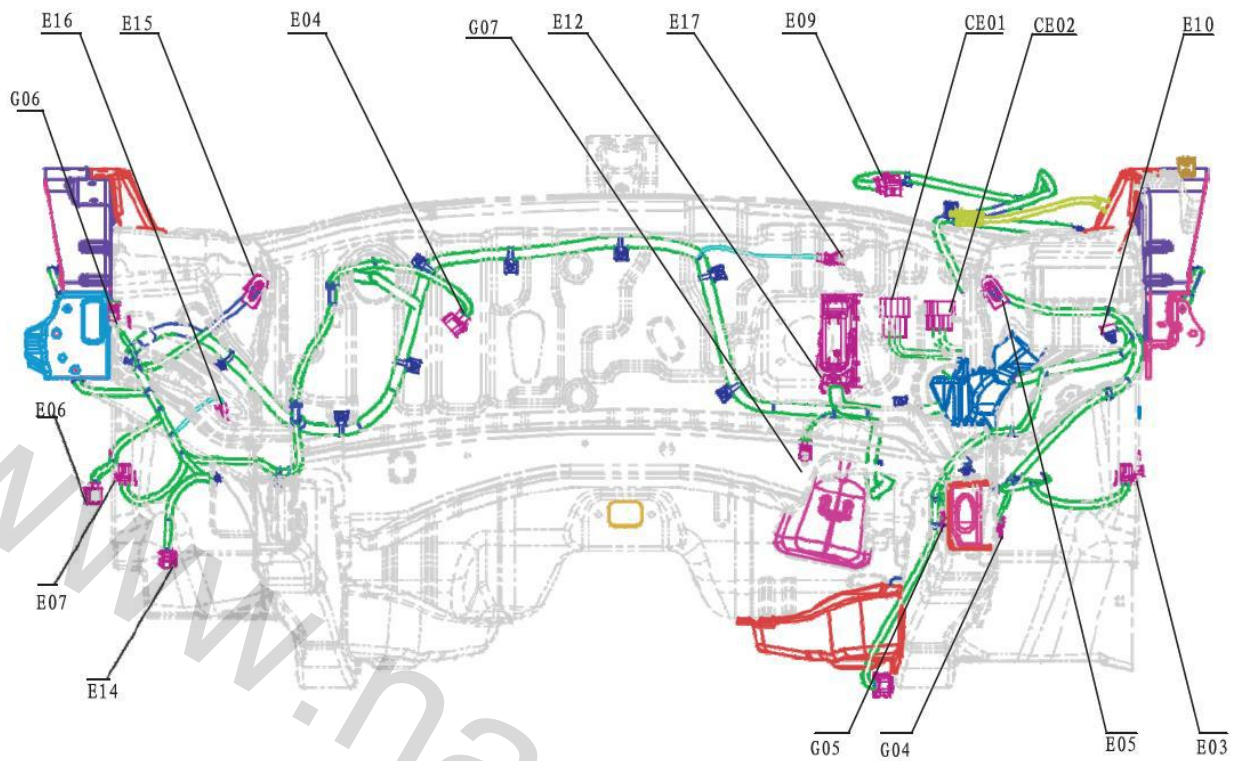

E09	Wiper motor
E17	Brake Fluid Level Sensor
CE01	Connect to the connector 1 with engine control wiring wire harness
CE02	Connect to the connector 2 with engine control wiring wire harness
E04	Cooling fan
E12	ABS motor
E15	Right headlamp
E10	Vacuum pump motor
E06	Washing motor connector
E07	Three-way pressure switch
E14	Right front fog lamp connector
E16	Connect to compressor connector
E05	Left front headlamp wire harness
E03	Left front fog lamp wire harness

Engine Compartment Wire Harness (2)

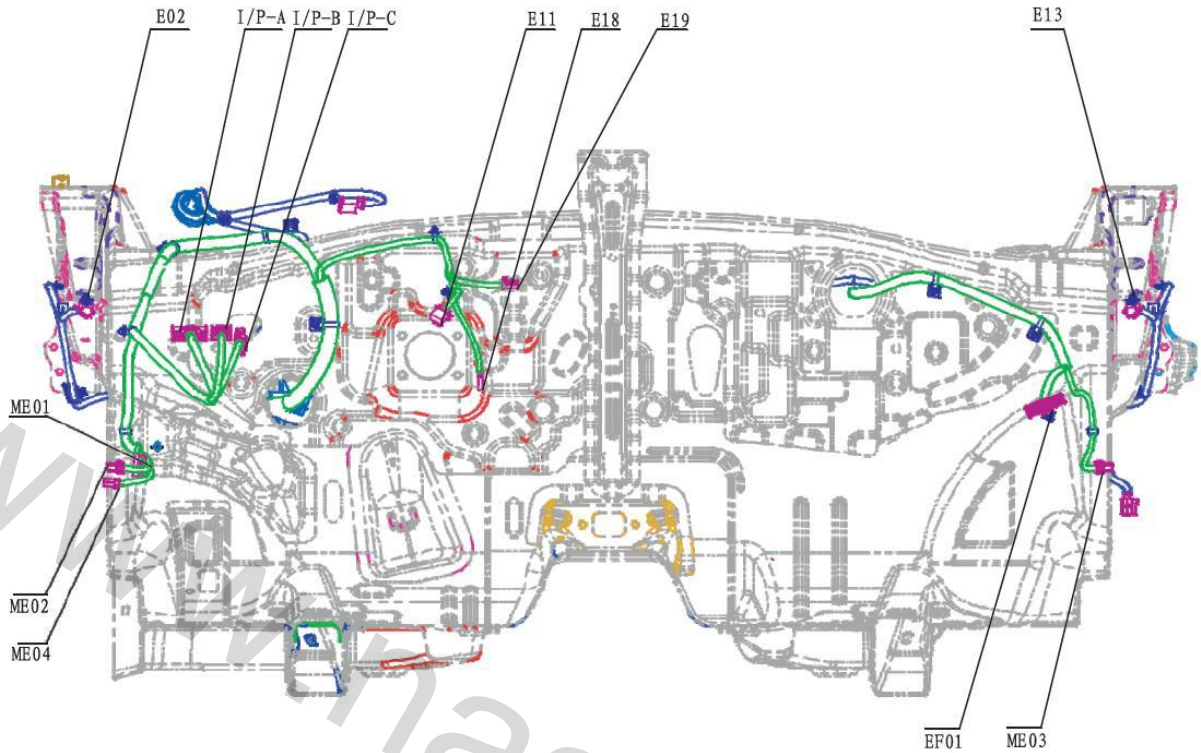

E13	Left front wheel speed sensor
E12	Right front wheel speed sensor
E11	Brake switch
E18	Clutch switch 1
E19	Clutch switch 2
I/P-A	Indoor terminal box connector A
I/P-B	Indoor terminal box connector B
I/P-C	Indoor terminal box connector C

Component Position Diagram

Frame Wire Harness	CL-2
Door Wire Harness	CL-6
Ground Wire Wire Harness	CL-7
Power Wire Harness	CL-10
Ceiling Wire Harness	CL-11
Engine Wire Harness	CL-12
Control Wire Harness	CL-16
Tailgate Wire Harness	CL-19
Main Wire Harness	CL-21

www.nasicoelec.ir

Frame Wire Harness

Frame Wire Harness (1)

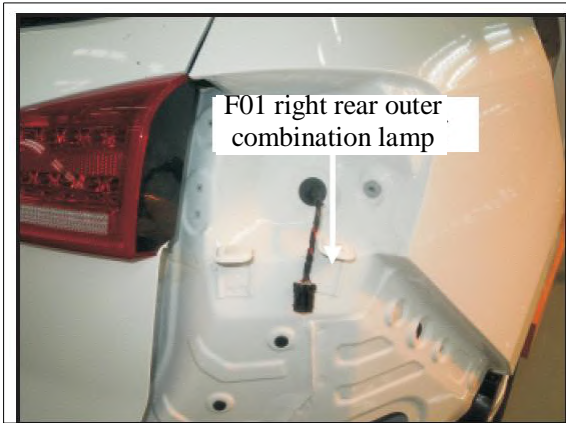

F01



F02

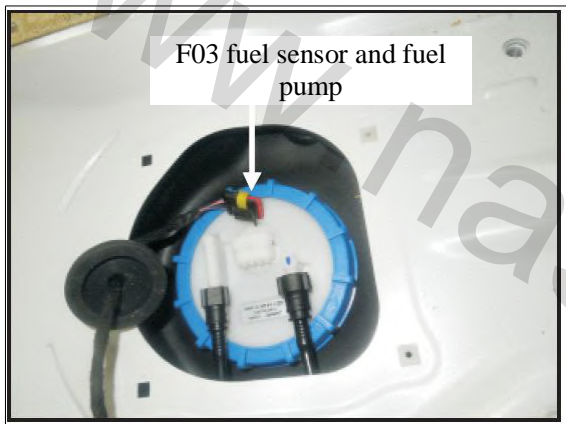

F03

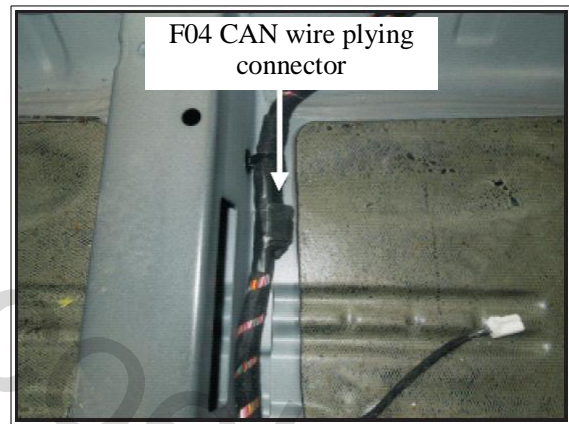

F04



F05

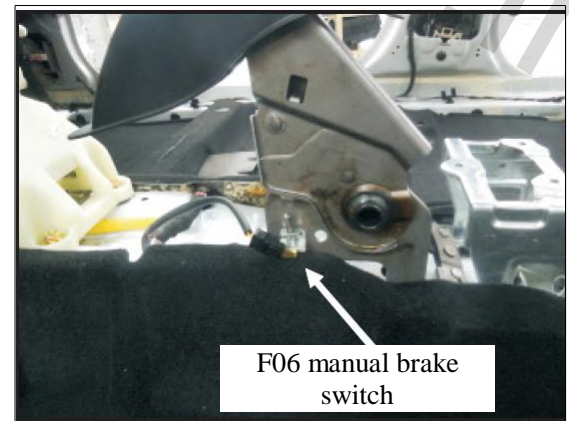

F06

Frame Wire Harness (2)

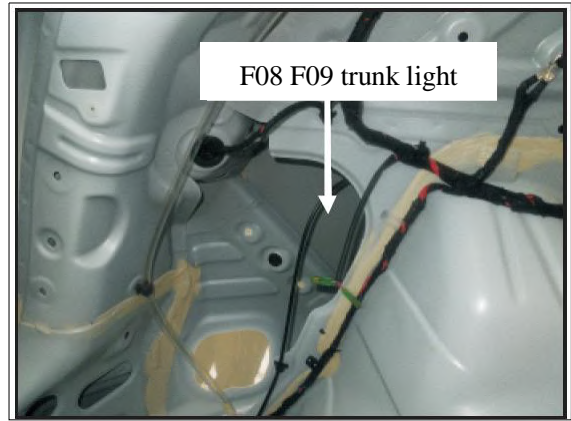
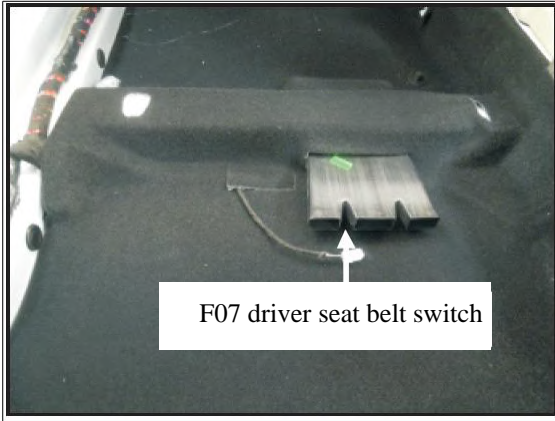

F07

F08 F09

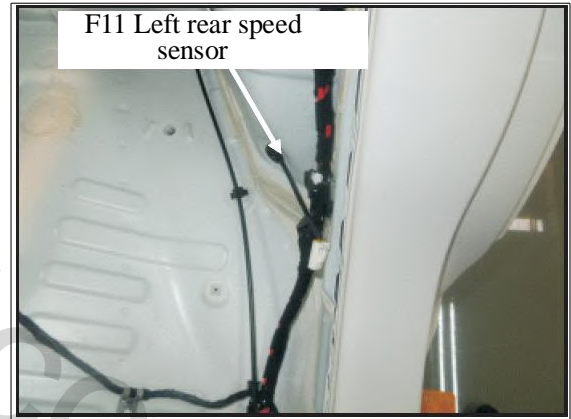
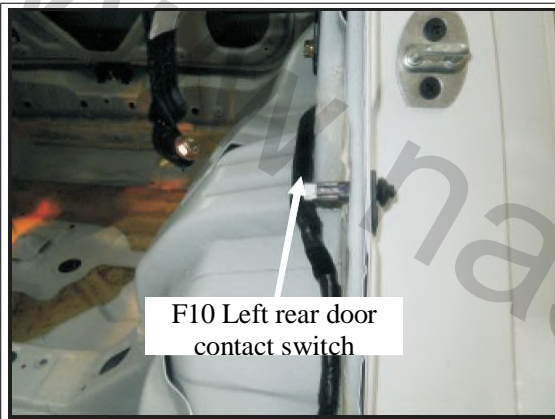

F10

F11

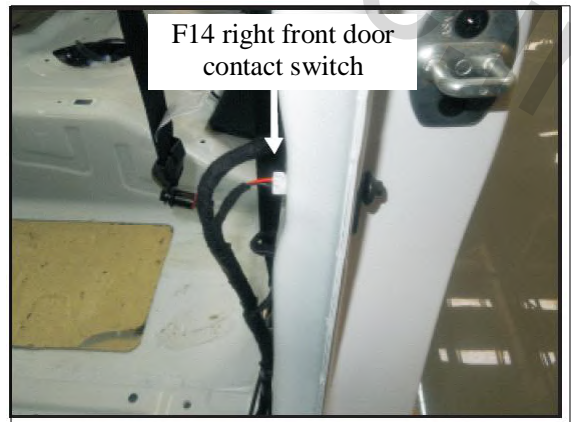
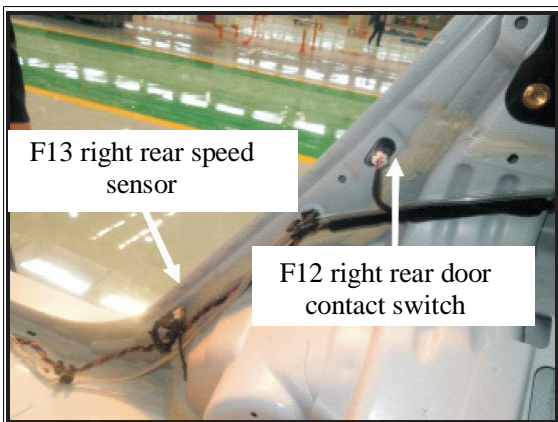

F12 F13

F14

Frame wire harness (3)



F15



F16

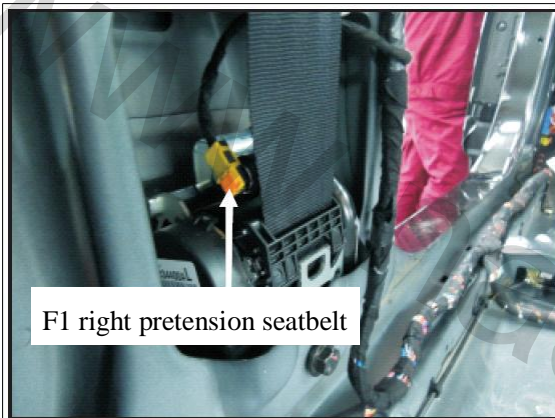

F1

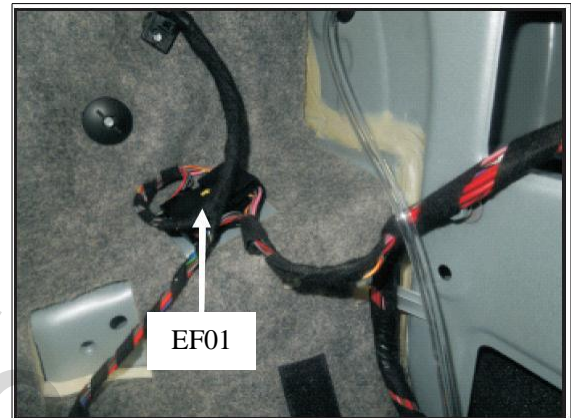

EF01

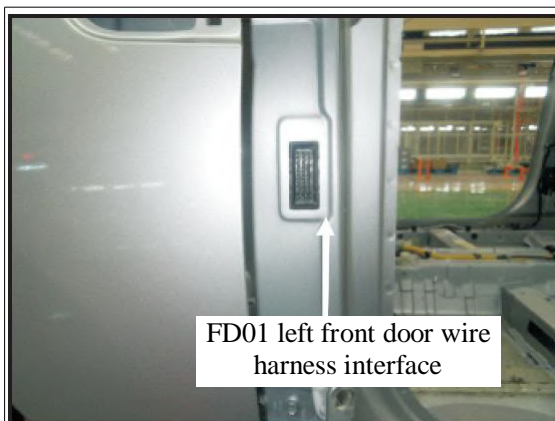

FD01

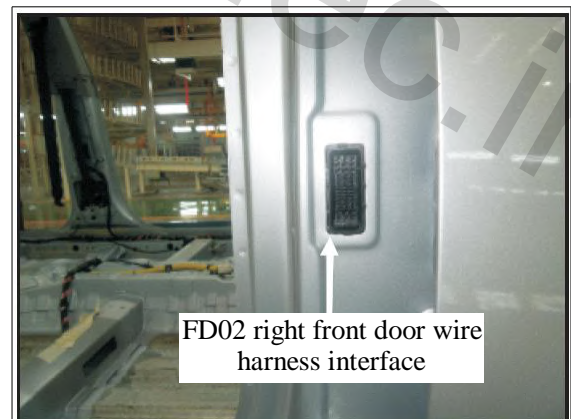

FD02

Frame Wire Harness (4)

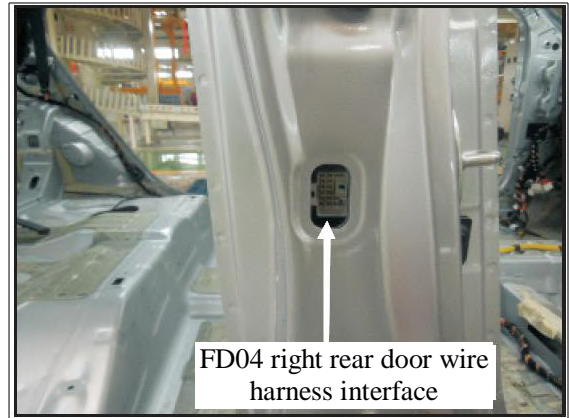
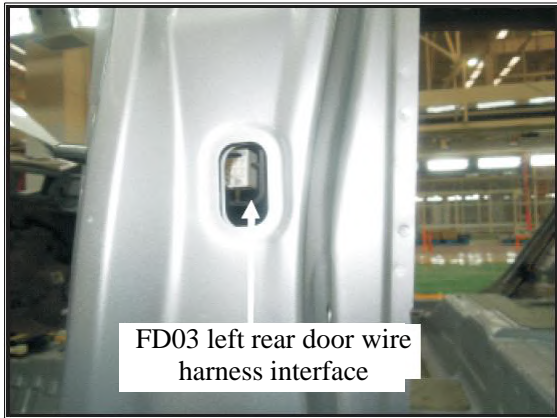

FD03

FD04

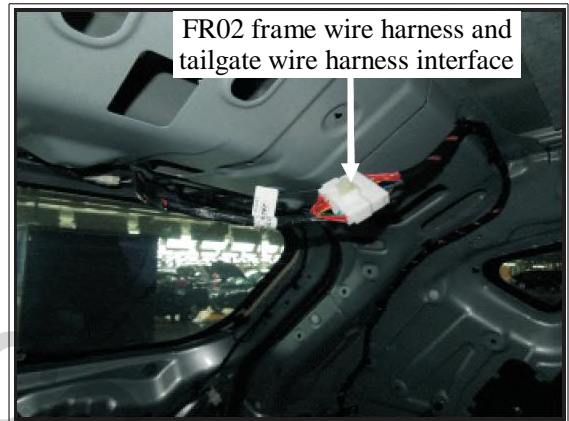
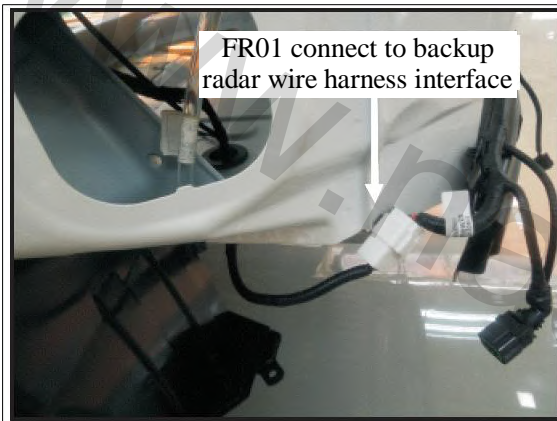

FR01

FR02

www.sic-elec.ir

Door wire harness

Door wire harness (1)

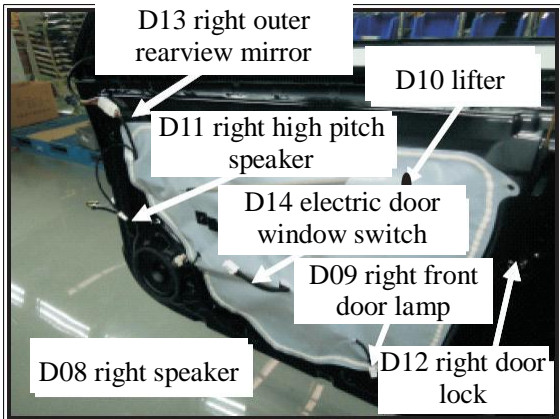

D08 D09 D10 D11 D12 D13 D14

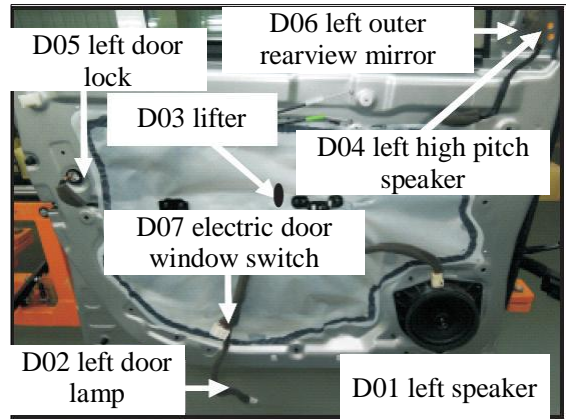

D01 D02 D03 D04 D05 D06 D07

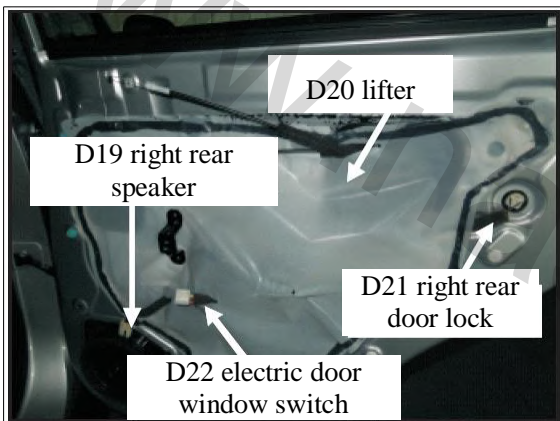

D19 D20 D21 D22

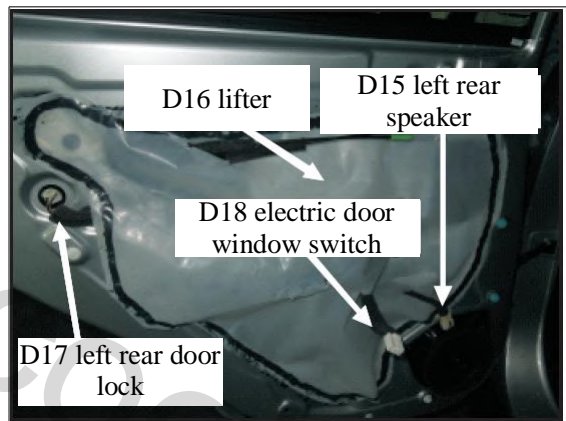

D15 D16 D17 D18

Ground wire wire harness

Ground wire wire harness (1)

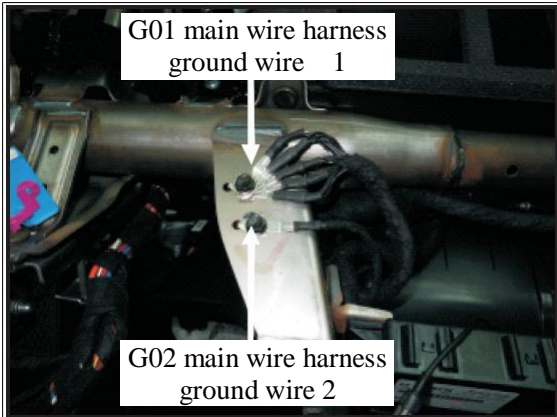

G01 G02

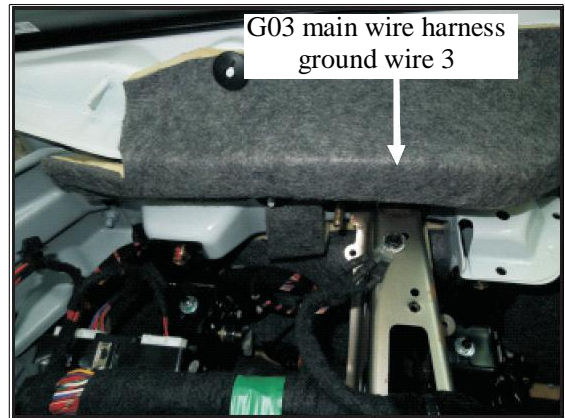

G03

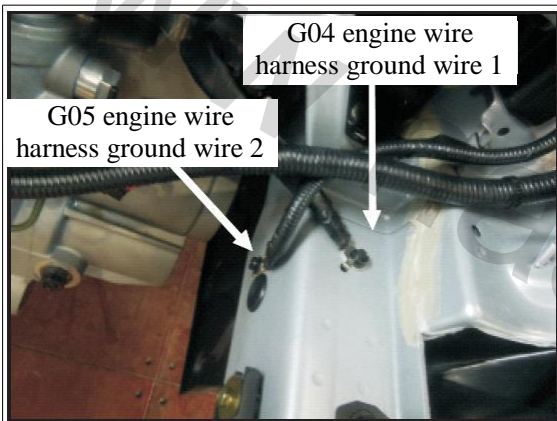

G04 G05

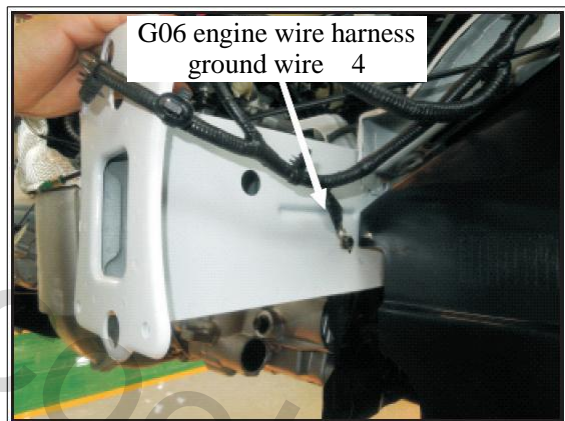

G06

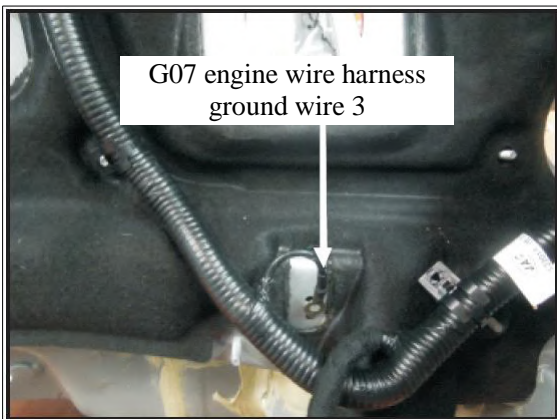

G07

Ground wire wire harness (2)



G08 frame wire harness
ground wire 4

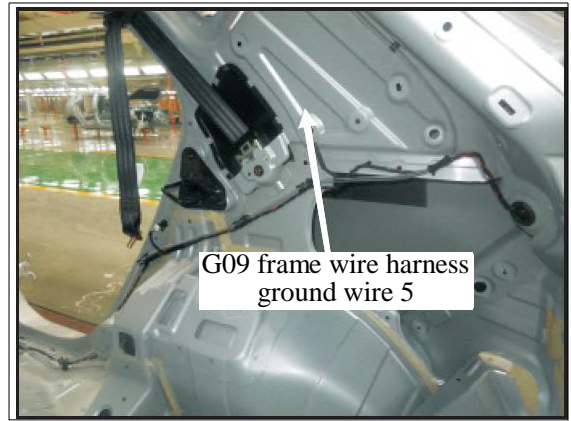

G09 frame wire harness
ground wire 5

G08

G09

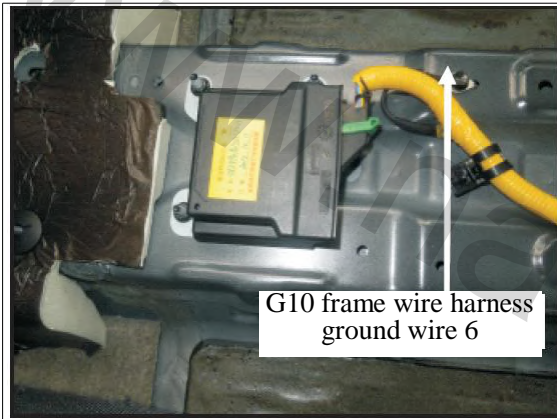

G10 frame wire harness
ground wire 6



G11 frame wire harness
ground wire

G10

G11

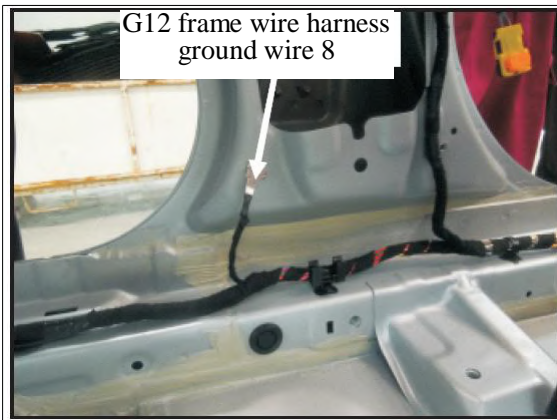

G12 frame wire harness
ground wire 8

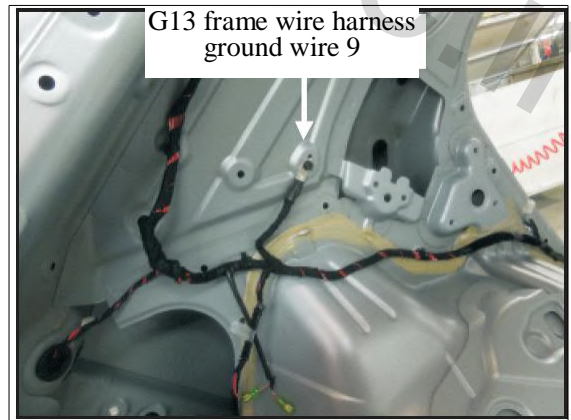

G13 frame wire harness
ground wire 9

G12

G13

Ground wire wire harness (3)

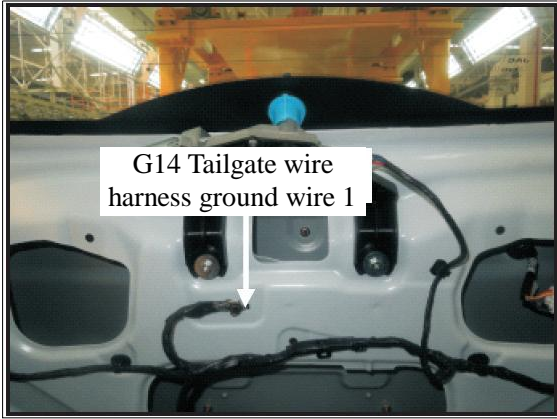

G14

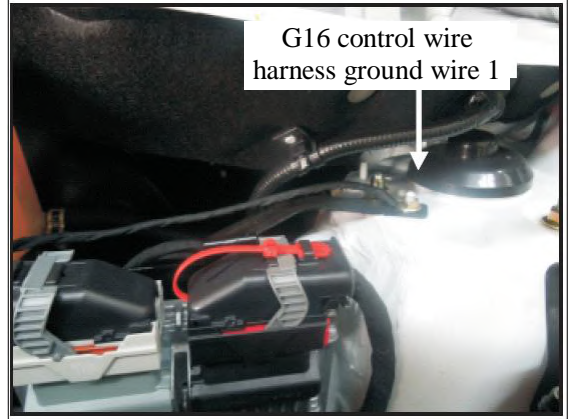

G16

Power Wire Harness

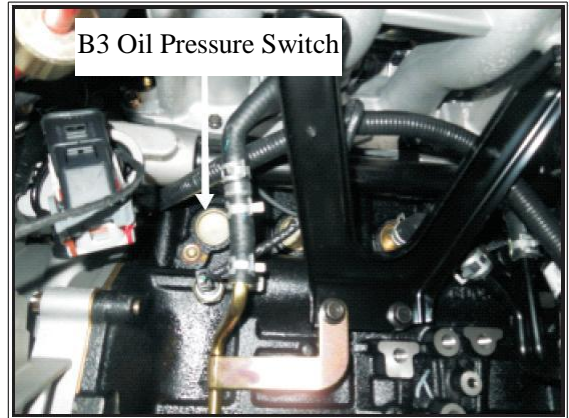
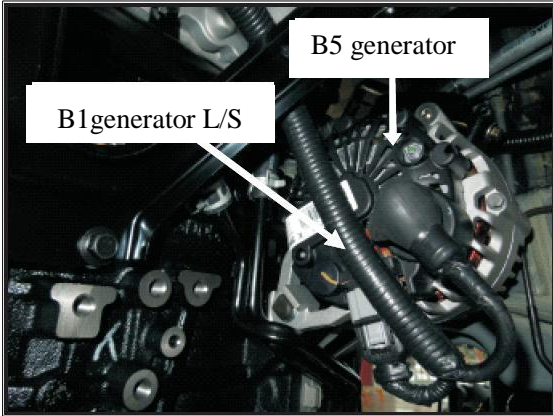

B1 B5

B3

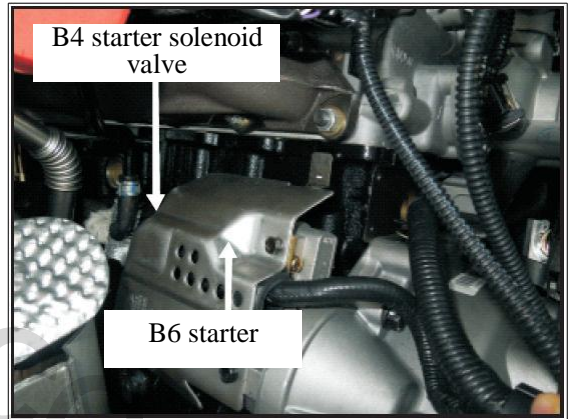
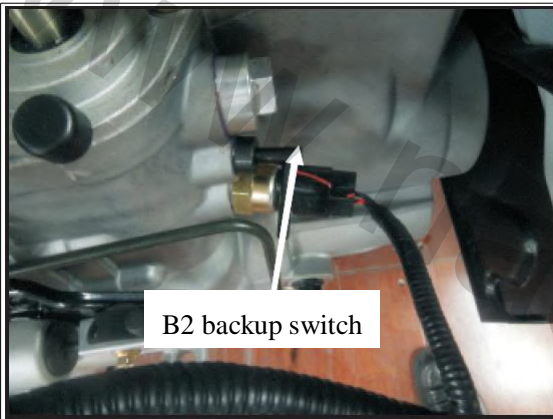

B2

B4 B6

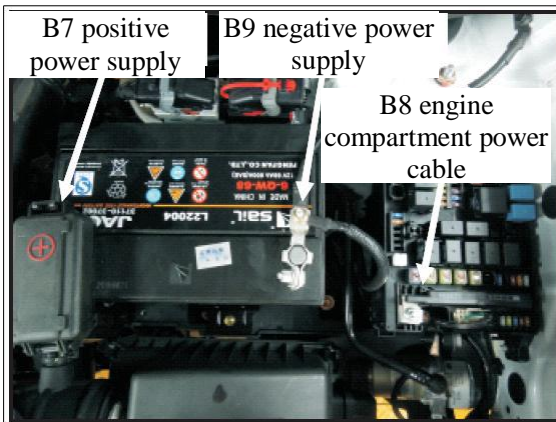

B7 B8 B9

Ceiling Wire Harness

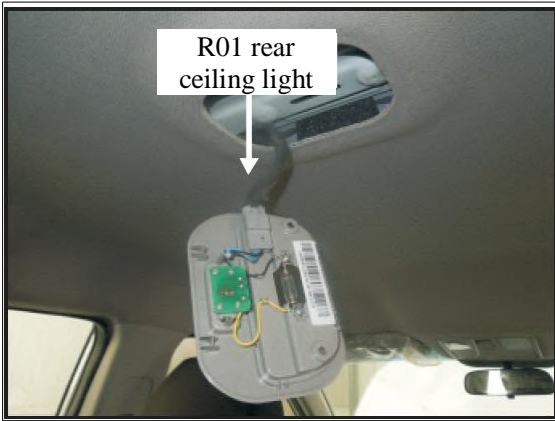

R01 rear ceiling light



R02 front ceiling light

R01

R02



R03 left sunvisor light



R04 right sunvisor light

R03

R04

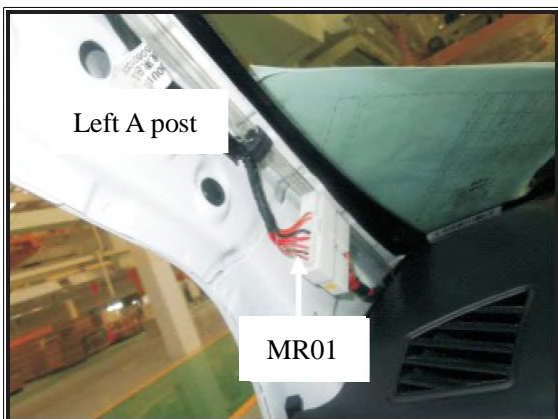

Left A post

MR01

MR01



R06 interior rear mirror

R06

Engine Wire Harness

Engine Wire Harness (1)

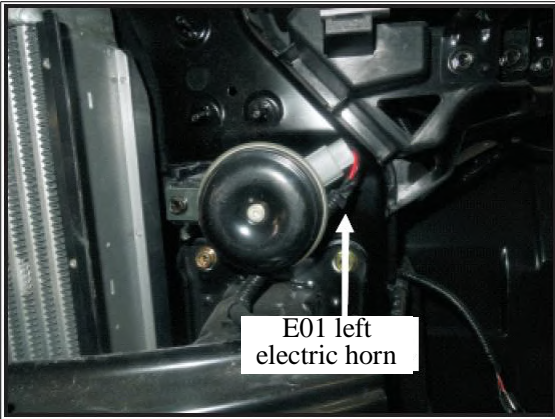

E01

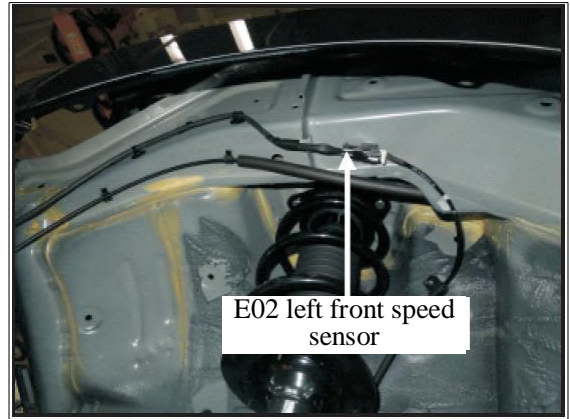

E02



E03

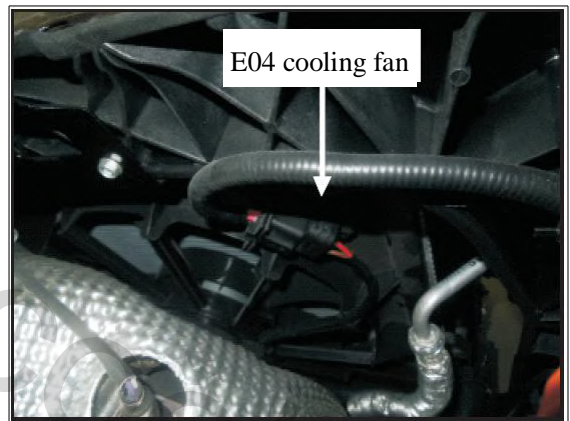

E04



E05

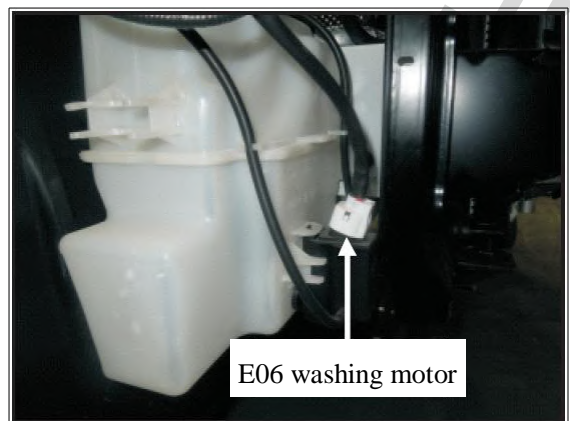

E06

Engine Wire Harness (2)

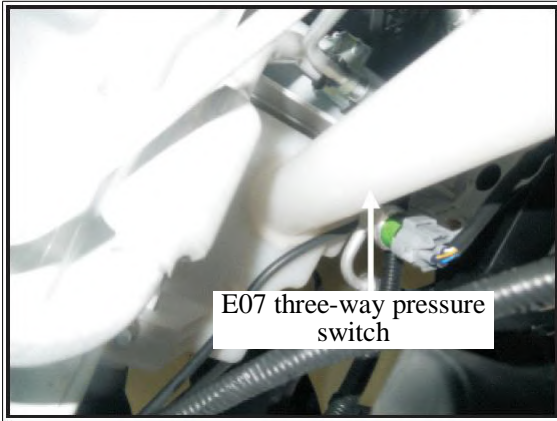

E07

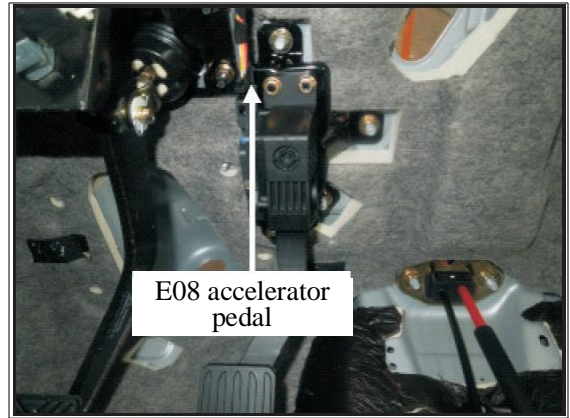

E08

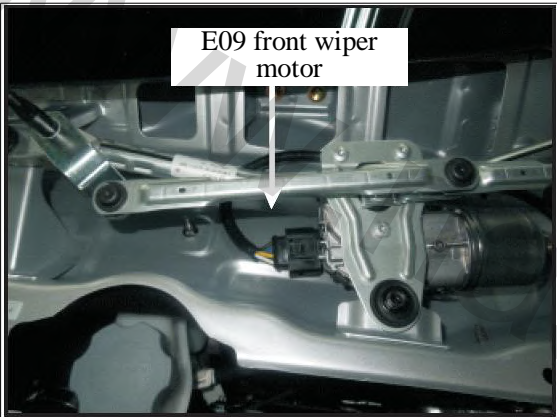

E09

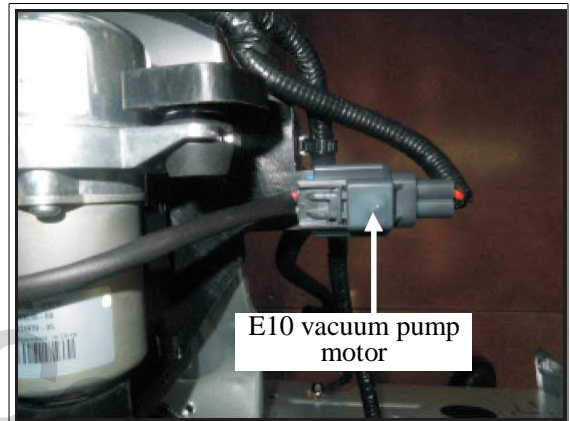

E10

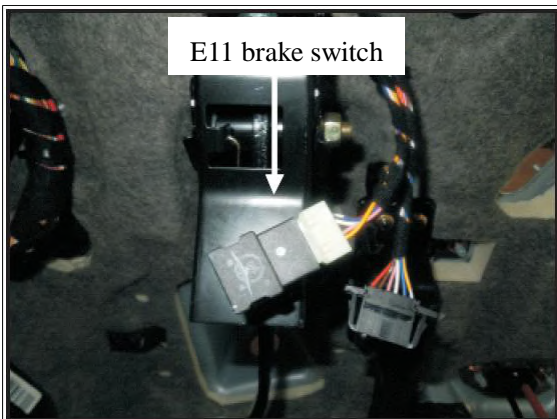

E11

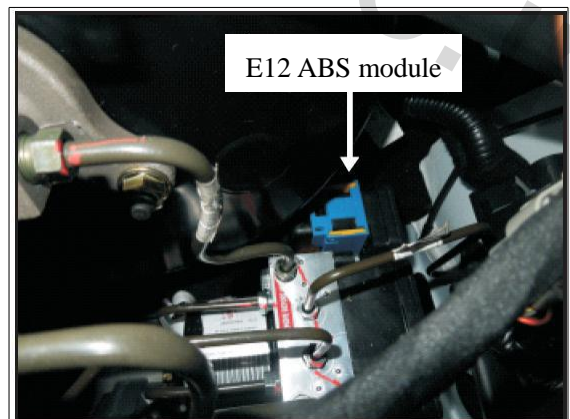

E12

Engine Wire Harness (3)

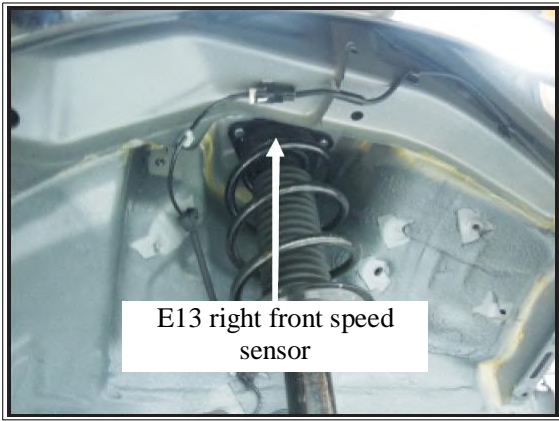

E13

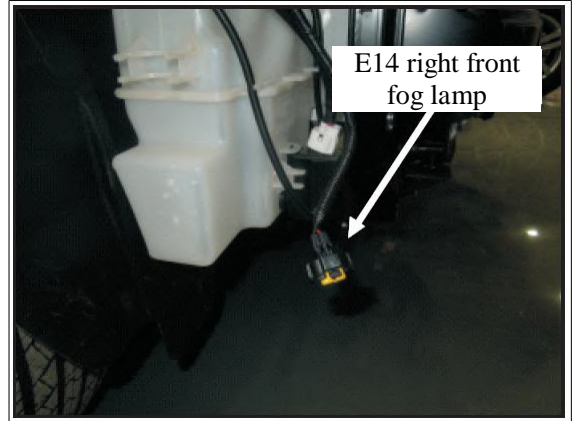

E14

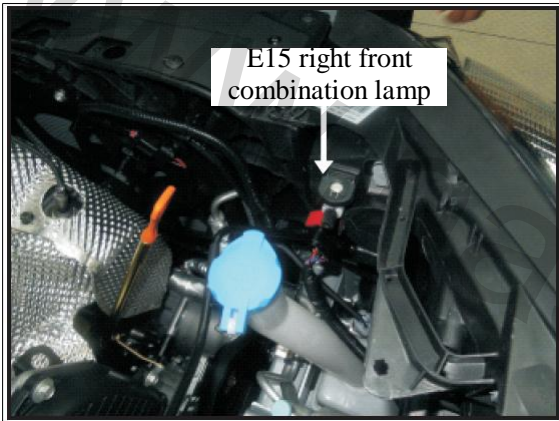

E15



E16

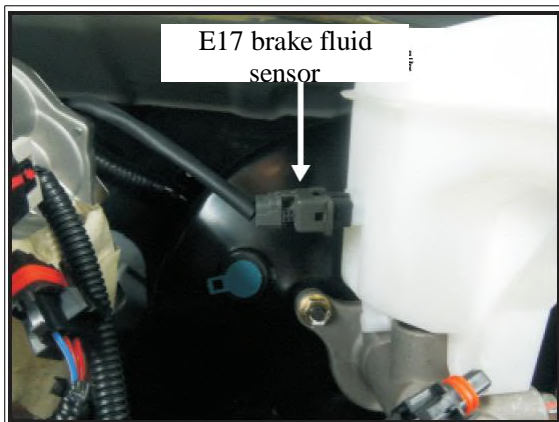

E17

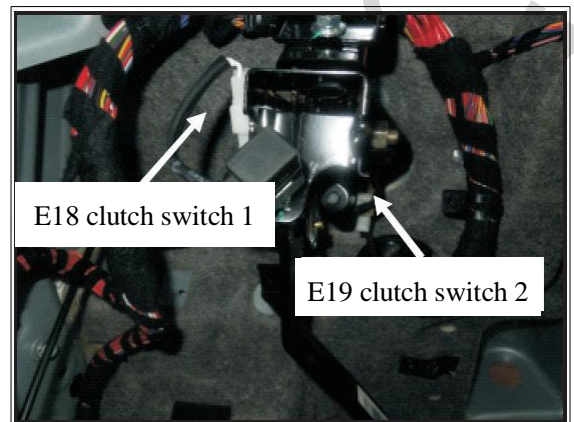

E18 E19

Engine wire harness (4)

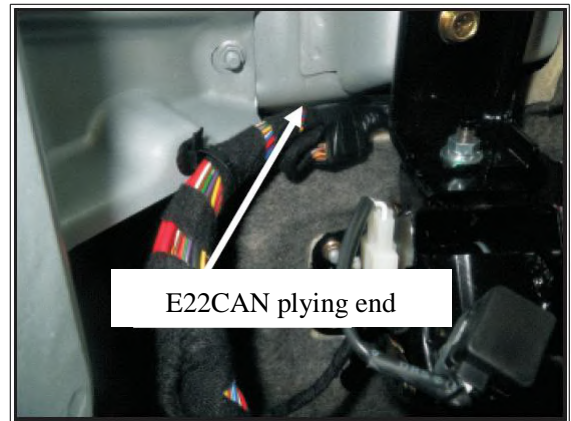
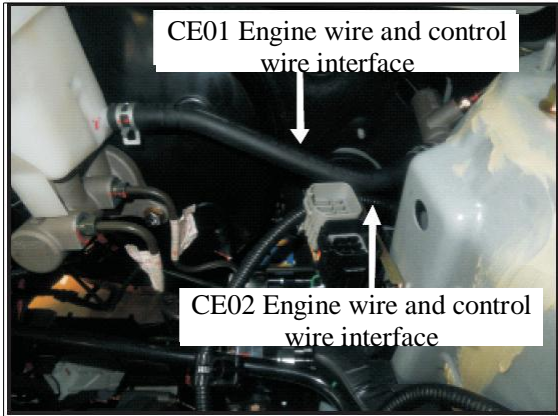

CE01 CE02

E22

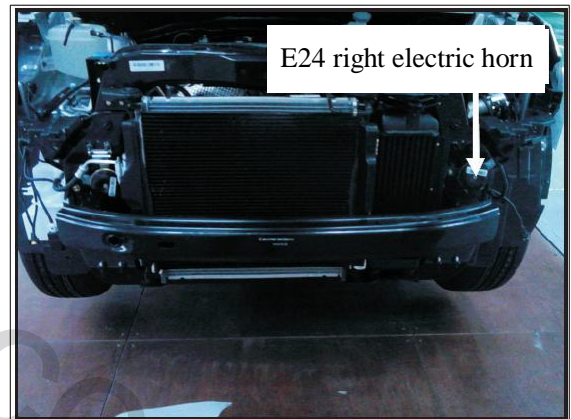
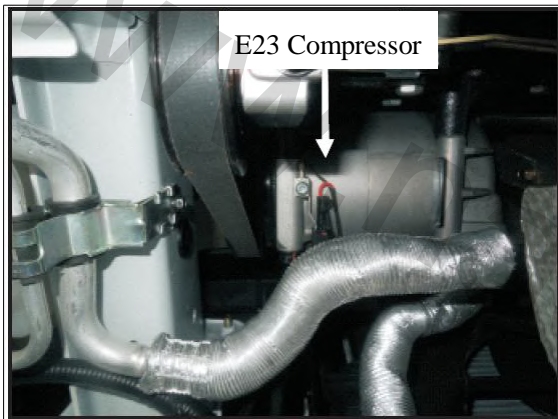

E23

E24

www.sicoelec.ir

Control Wire Harness

Control Wire Harness (1)

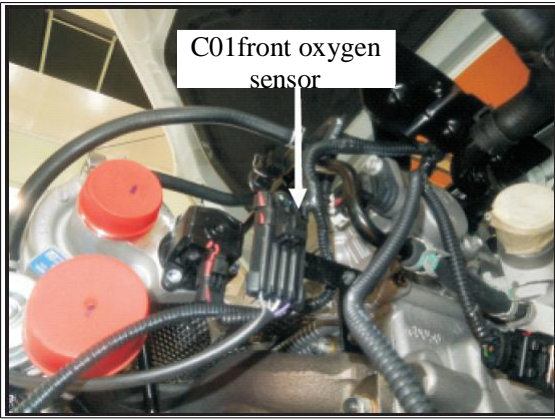

C01

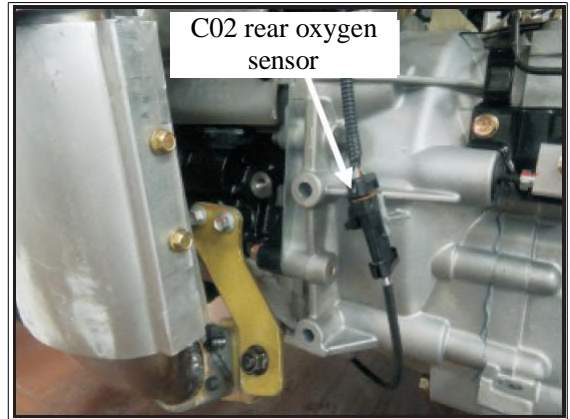

C02

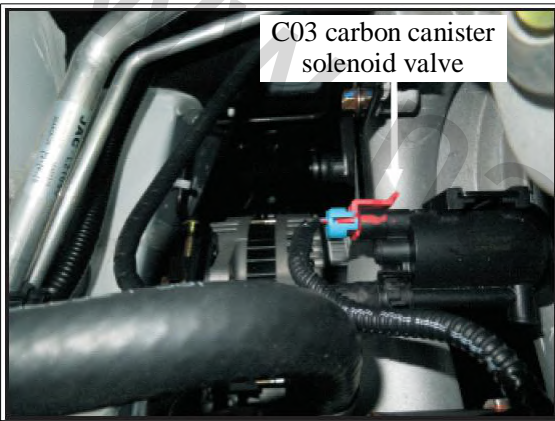

C03

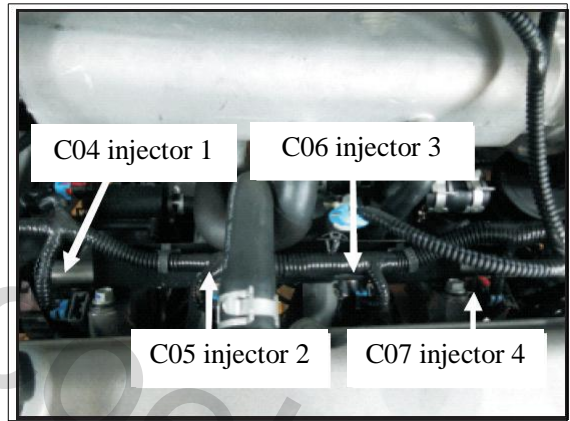

C04 C05 C06 C07

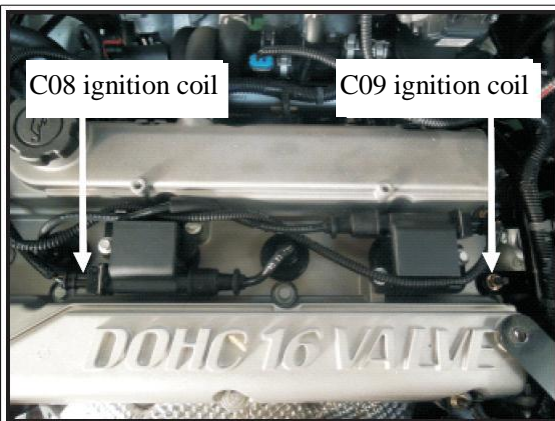

C08 C09



C21

Control Wire Harness (2)

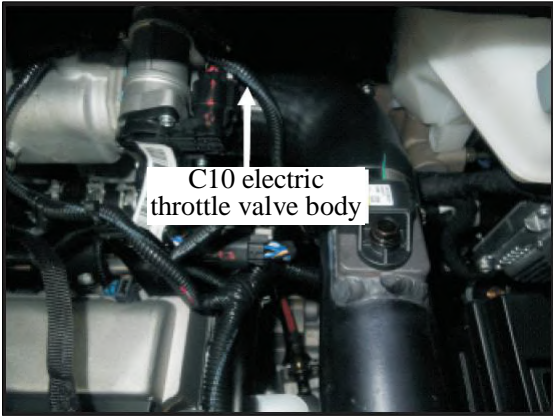

C10

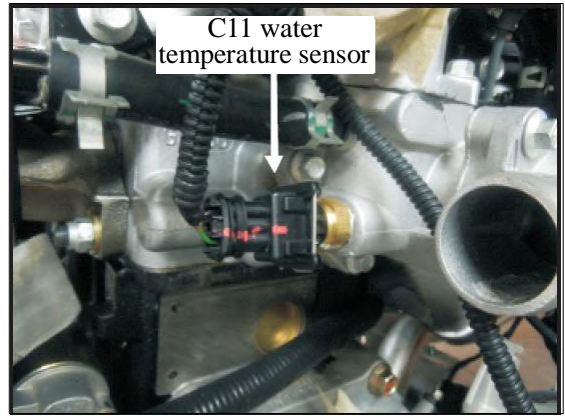

C11

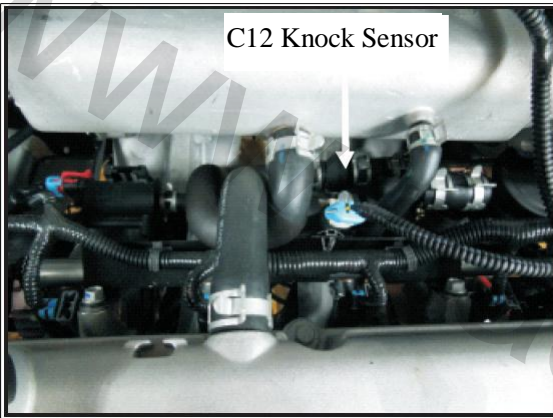

C12

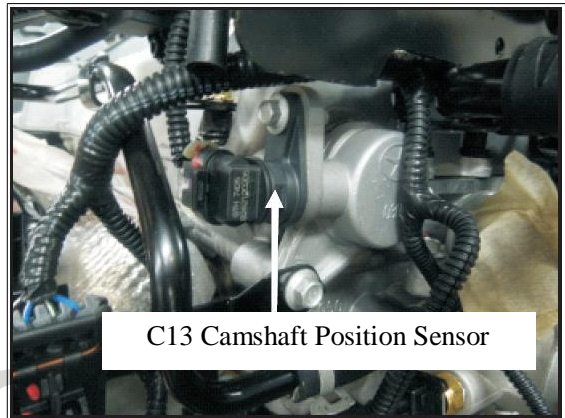

C13

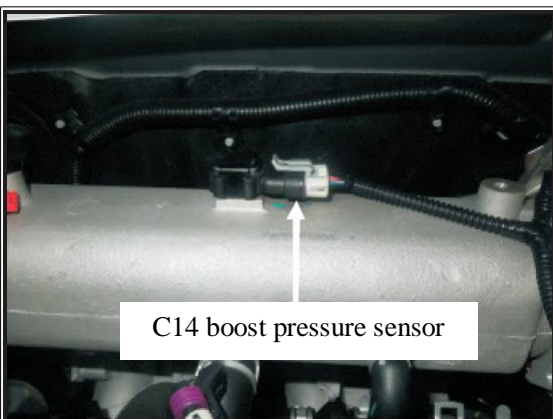

C14

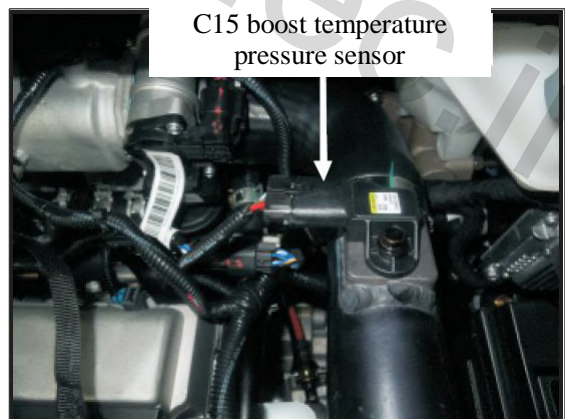

C15

Control Wire Harness (3)

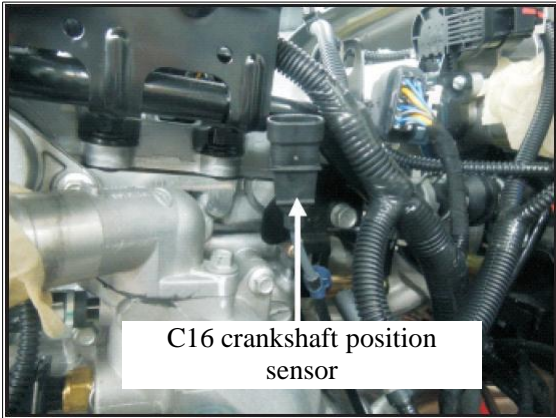

C16

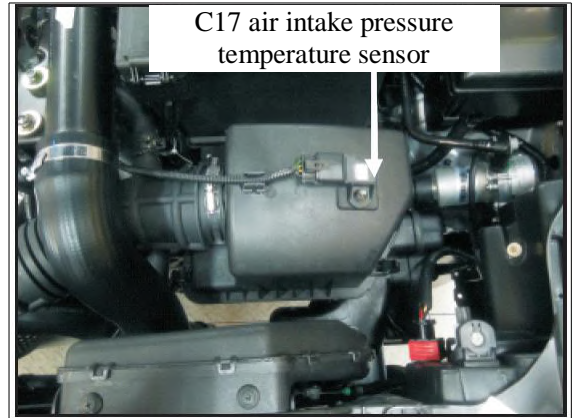

C17

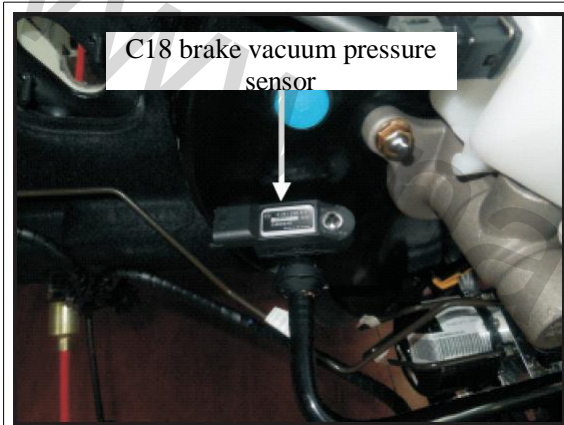

C18

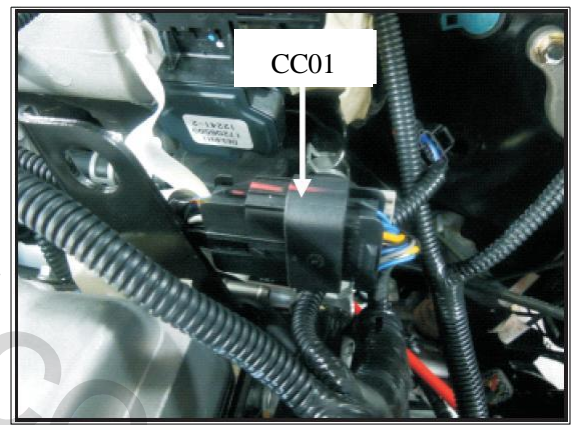

CC01

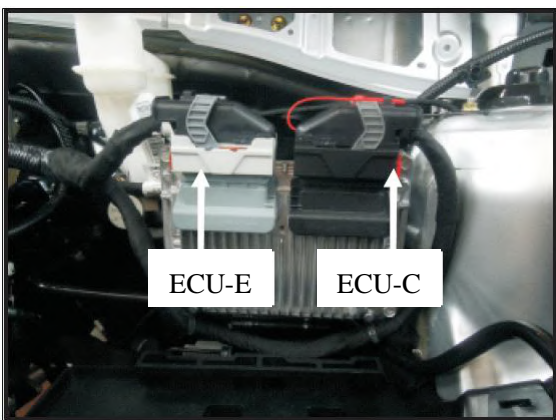

ECU-E ECU-C

Tailgate Wire Harness

Tailgate Wire Harness (1)

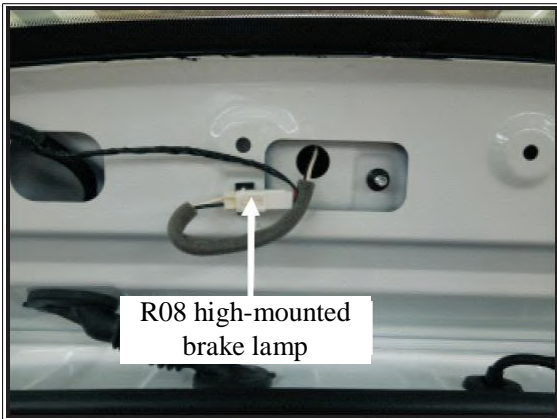

R08

R09

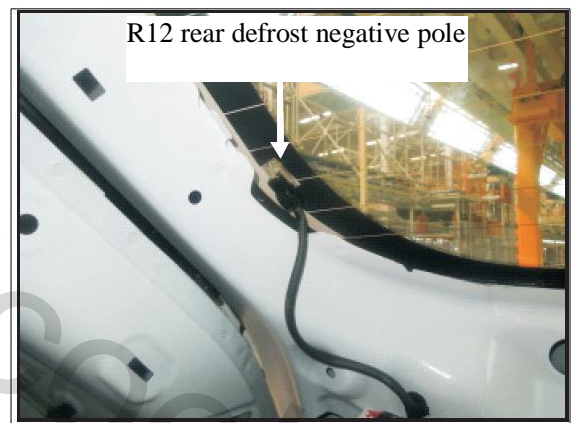

R10

R12

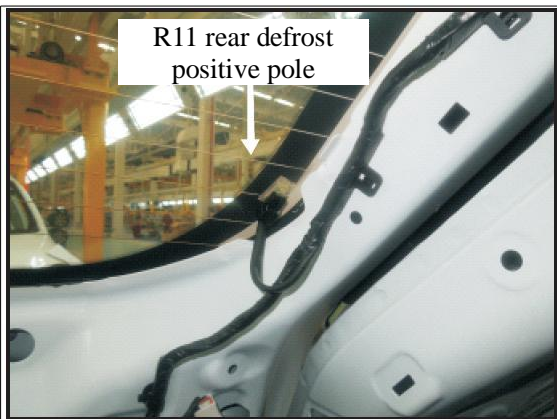

R11

R13

Tailgate Wire Harness (2)

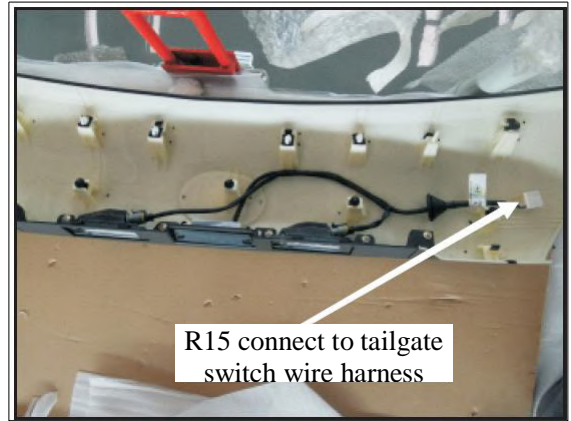

R14

R15

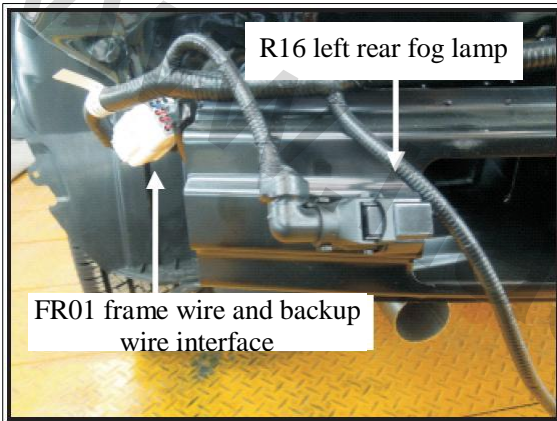

R16 FR01

R17

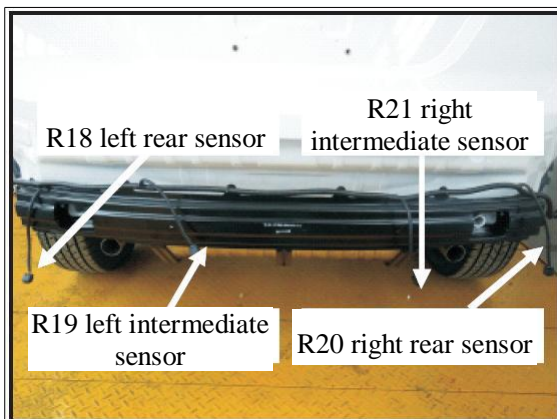

R18 R19 R20 R21

Main wire harness

Main wire harness (1)

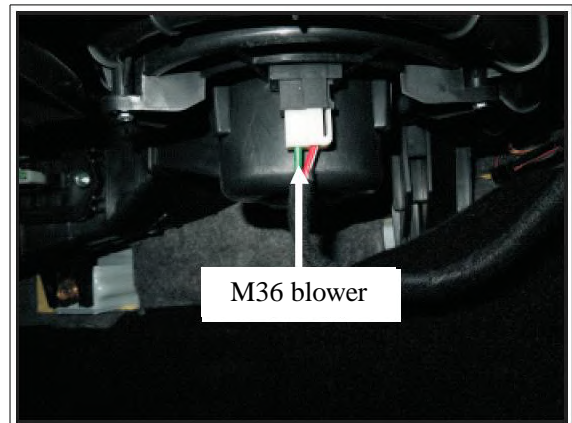
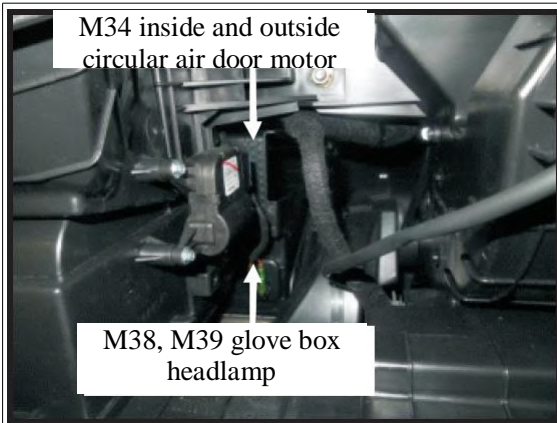

M38 M39 M34

M36

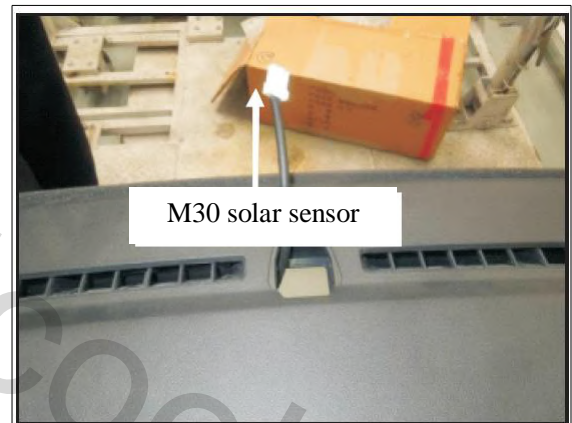
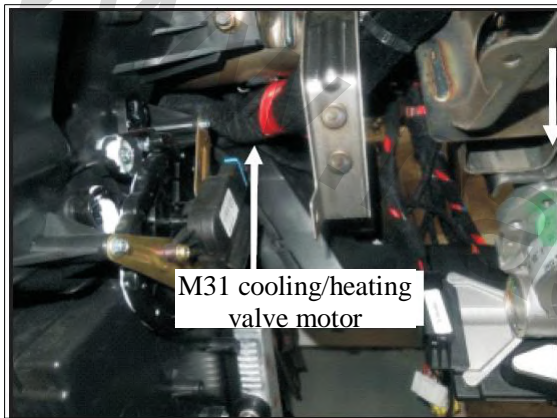

M31

M30

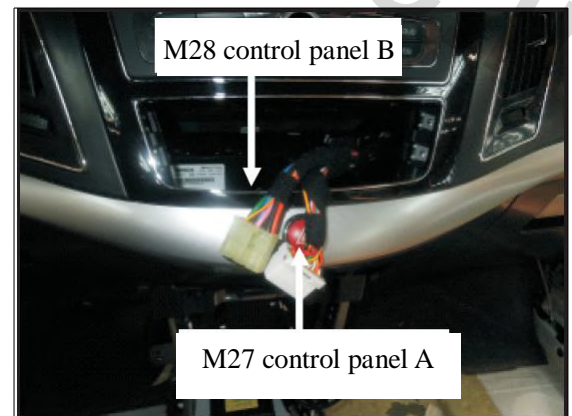
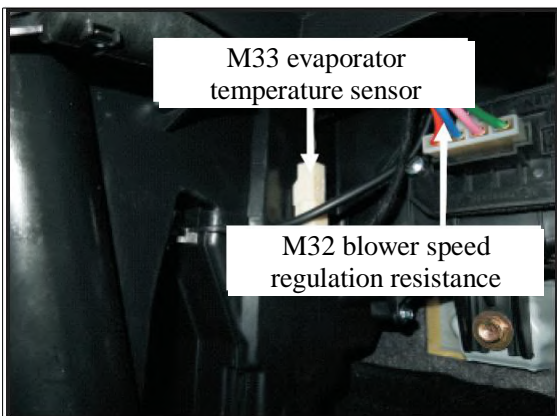

M32 M33

M27 M28

Main Wire Harness (2)

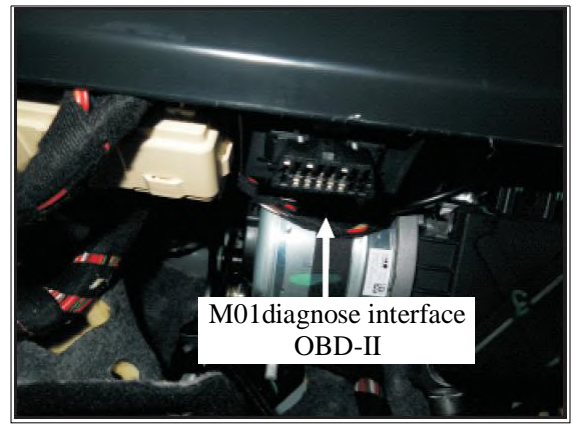
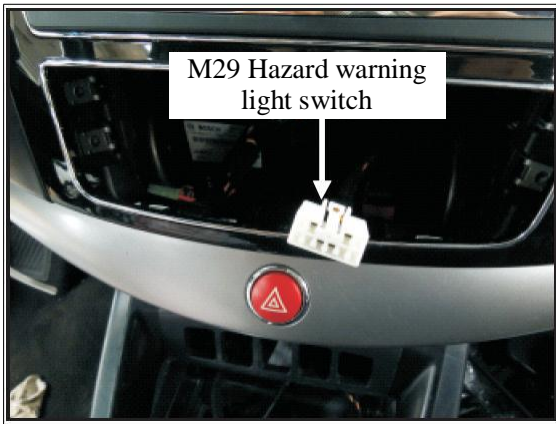

M29

M01

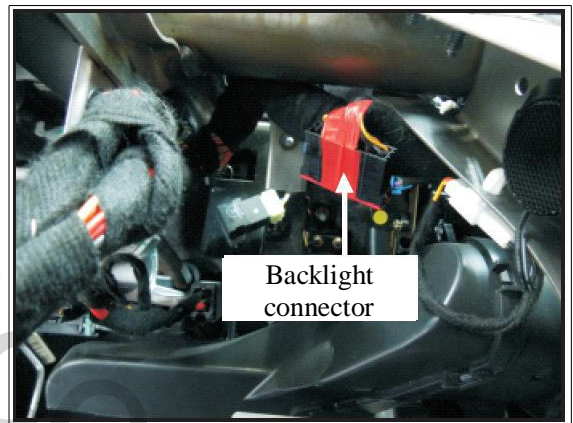
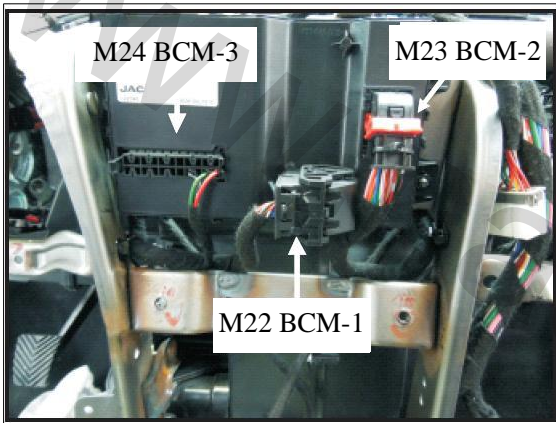

M22 M23 M24

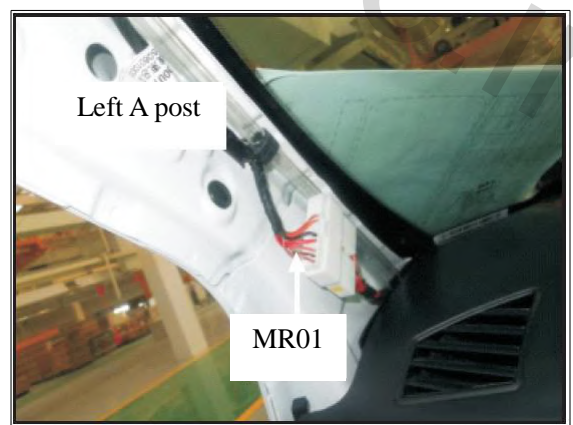
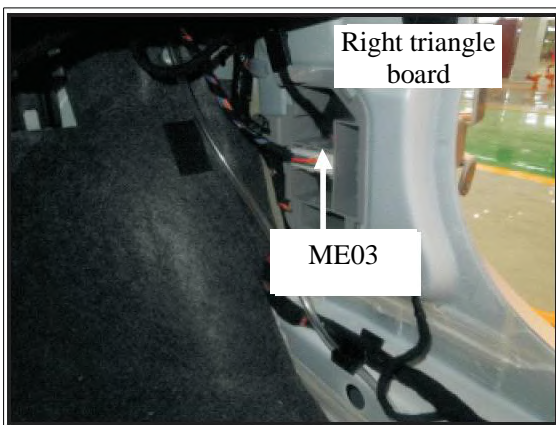

ME03

MR01

Main Wire Harness (3)

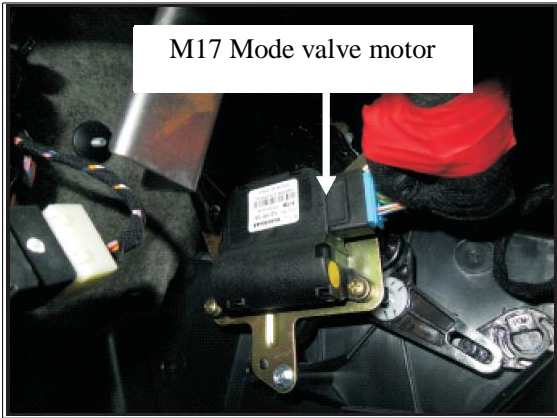

M17



M18

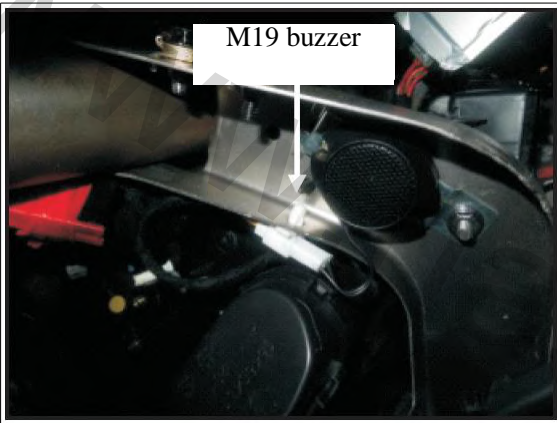

M19

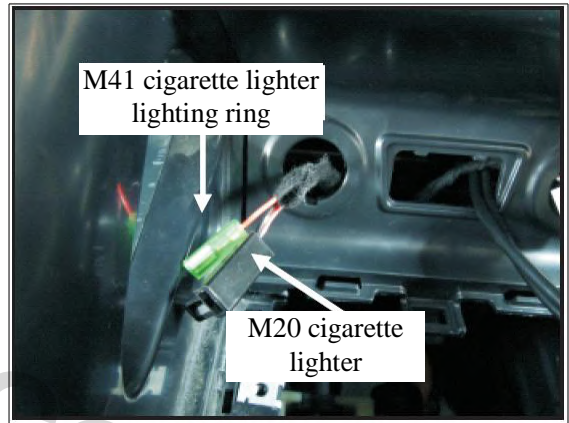

M20 M41

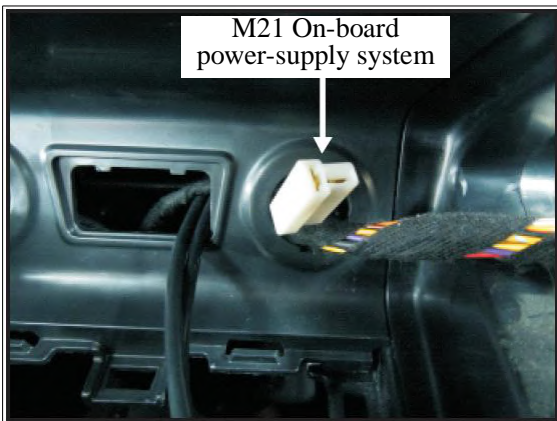

M21

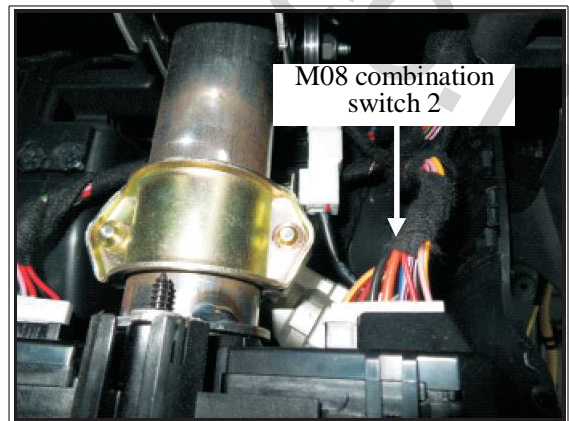

M08

Main Wire Harness (4)

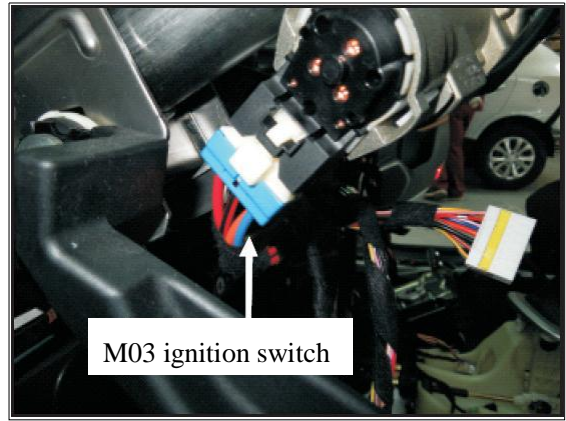

M07

M03

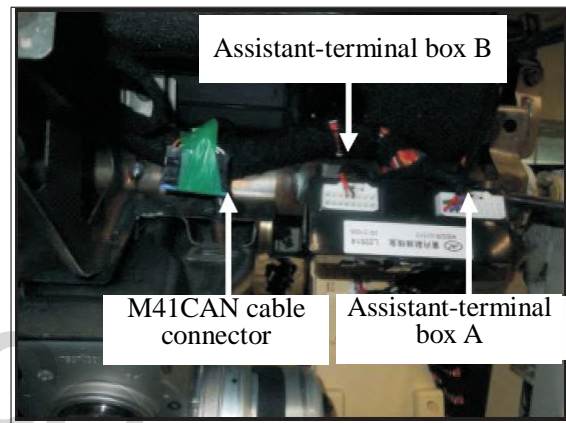
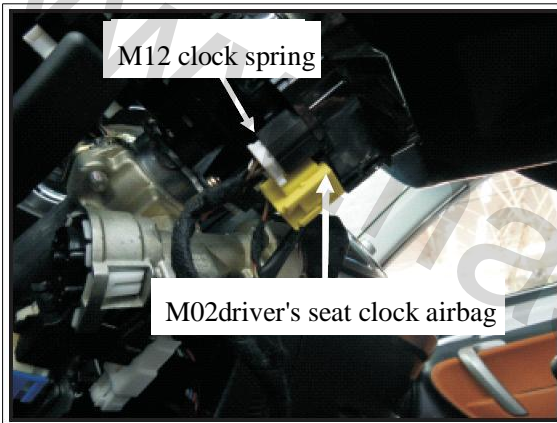

M02

M12

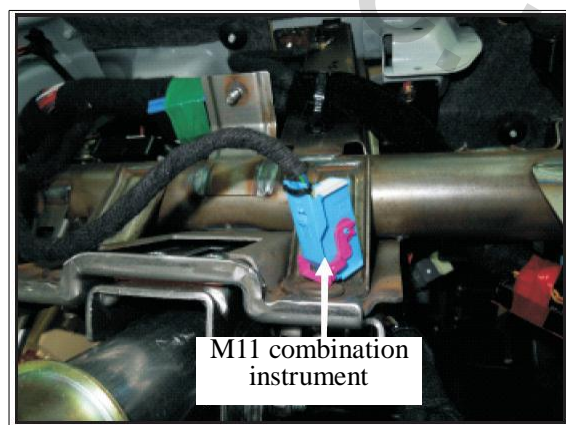
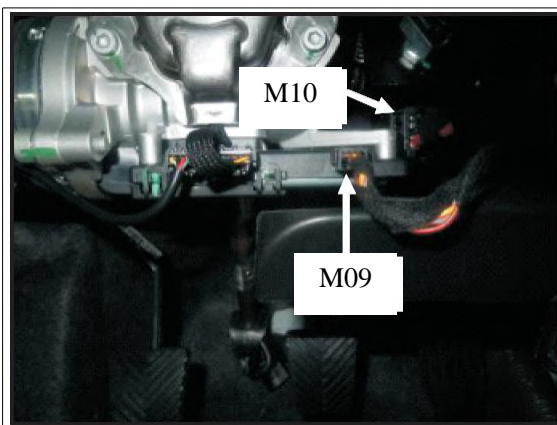

M09 M10

M11

Main wire harness (5)

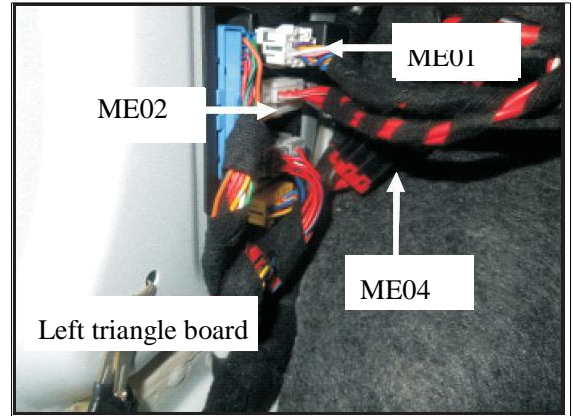
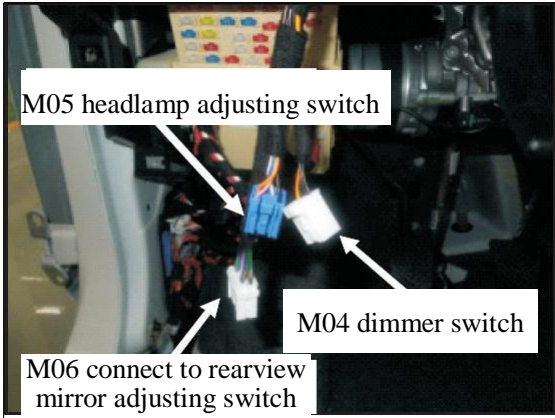

M04 M05 M06

ME01 ME02 ME04

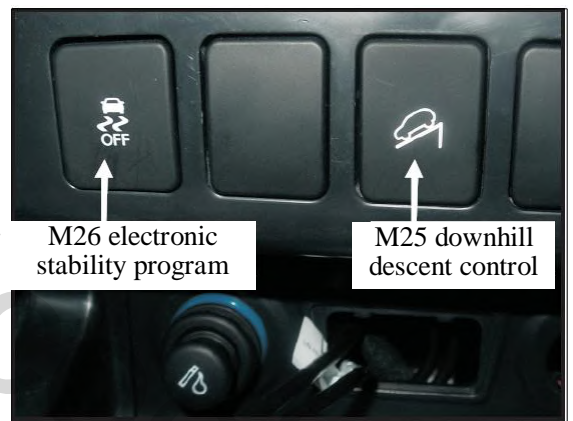
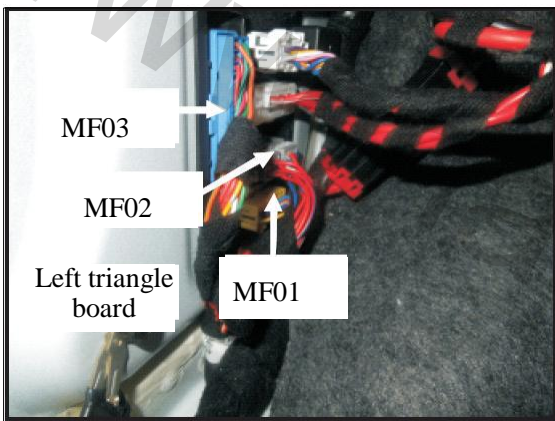

MF01 MF02 MF03

M25 M26