

### Features

- Stand-by output 180 mA;  $5\text{ V} \pm 2\%$
- Adjustable reset switching threshold
- Main output 350 mA; tracked to the stand-by output
- Low quiescent current consumption in standby mode
- Disable function for main output
- Wide operation range: up to 45 V
- Very low dropout
- Power-On-Reset circuit sensing the stand-by voltage
- Early warning comparator for supply undervoltage
- Output protected against short circuit
- Wide temperature range:  $-40\text{ }^{\circ}\text{C}$  to  $150\text{ }^{\circ}\text{C}$
- Over-temperature protection
- Over-load protection

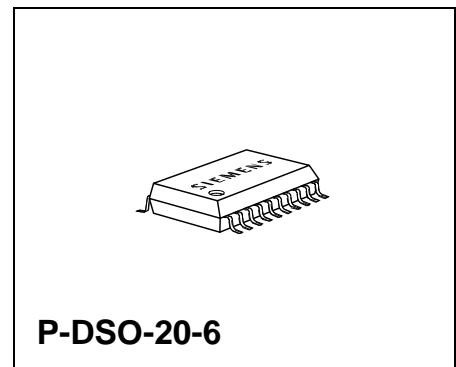
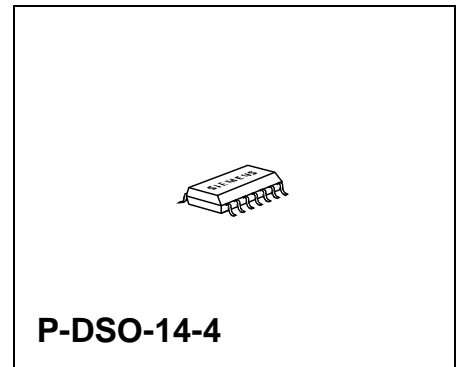

Type	Ordering Code	Package
TLE 4470 GS	Q67006-A9309	P-DSO-14-4 (SMD)
TLE 4470 G	Q67006-A9308	P-DSO-20-6 (SMD)

### Functional Description

The TLE 4470 is a monolithic integrated voltage regulator with two very low-drop outputs, a main output Q2 for loads up to 350 mA and a stand by output Q1 providing a maximum of 180 mA. The device is available in both the P-DSO-14-4 and P-DSO-20-6 packages. It is designed to supply microprocessor systems under the severe conditions of automotive applications and is therefore equipped with additional protection functions against over load, short circuit and over temperature. Of course the TLE 4470 can also be used in other applications where two stabilized voltages are required.

The device operates in the wide temperature range of  $-40\text{ }^{\circ}\text{C}$  to  $150\text{ }^{\circ}\text{C}$ .

The stand by regulator transforms an input voltage  $V_i$  in the range of  $5.6\text{ V} \leq V_i \leq 45\text{ V}$  to  $V_{Q1\text{rated}} = 5\text{ V}$  within an accuracy of 2%, whereas the main regulator is adjustable. By use of an external voltage divider the main output voltage can be set to  $V_{Q2} \geq 5\text{ V}$  for the

TLE 4470 G type (P-DSO-20-6 package).  $V_{Q1}$  is compared to the voltage at pin VA, which is proportional to the output voltage  $V_{Q2}$ . A control amplifier drives the base of the series PNP transistor via a buffer.

The main output voltage  $V_{Q2}$  is tracked to the accuracy of the stand by output.

For the TLE 4470 GS (P-DSO-14-4 package) the output voltage is fixed to 5 V.

To save energy e.g. in battery powered body electronic applications, the main regulator can be switched off via the disable input, which causes the current consumption to drop to 180  $\mu$ A typical.

Two additional features of the TLE 4470 are an early warning comparator (can be used e.g. to monitor the supply voltage  $V_I$ ) and reset generator with an adjustable reset delay time. The TLE 4470 G (P-DSO-20-6 package) has in addition an adjustable reset switching threshold. This feature is useful with microprocessors which guarantee a safe operation down to voltages below the internally set reset threshold of 4.65 V typical.

Two functions are included in the reset generator, a power on reset and an under-voltage reset. The power on reset feature is necessary for a defined start of the microprocessor when switching on the application. The reset LOW signal is generated for a certain delay time after the output voltage  $V_{Q1}$  of the regulator has surpassed the reset threshold. An external delay capacitor sets the delay time. The under voltage reset circuit supervises the stand-by output voltage. In case  $V_{Q1}$  falls below the reset switching threshold the reset output is set LOW after a short reaction time. The reset LOW signal is generated down to an output voltage  $V_{Q1}$  of 1 V.

**Pin Configuration**

(top view)

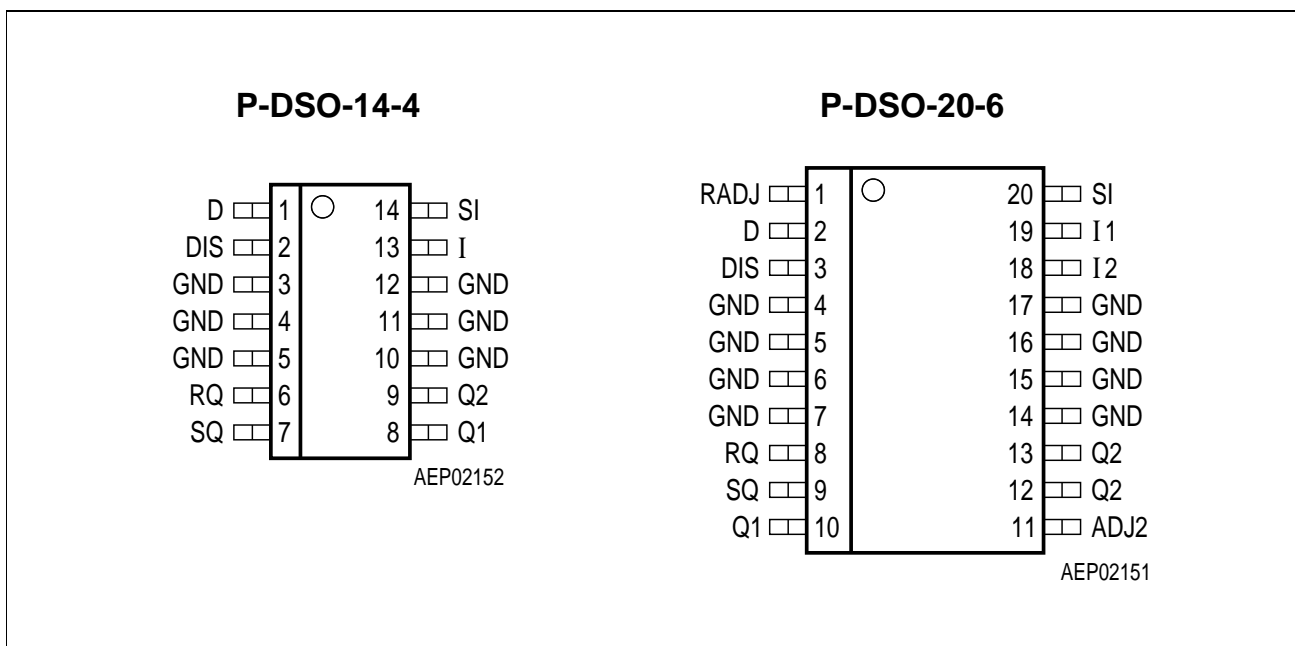

**Figure 1**

---

**Pin Definitions and Functions**
**P-DSO-20-6**

Pin No.	Symbol	Function
1	RADJ	<b>Reset switching threshold adjust</b> ; for setting the reset switching threshold connect to a voltage divider from Q1 to GND. If this input is connected to GND, the reset is triggered at the internal threshold.
2	D	<b>Reset delay</b> ; connect a capacitor $C_D$ to GND for delay time adjustment
3	DIS	<b>Disable input main regulator</b> ; Q2 disabled with high signal
4, 5, 6, 7	GND	<b>Ground</b>
8	RQ	<b>Reset output</b> ; the open collector output is connected to Q1 via an integrated 30 k $\Omega$ resistor
9	SQ	<b>Sense output</b> ; the open collector output is connected to Q1 via an integrated 30 k $\Omega$ resistor
10	Q1	<b>Stand-by regulator output voltage</b> ; block to GND with a capacitor $C_{Q1} \geq 6 \mu\text{F}$ , ESR < 10 $\Omega$ at 10 kHz
11	ADJ2	<b>Main regulator adjust input</b> ; Q2 can be set to higher values by an external divider
12, 13	Q2	<b>Main regulator output voltage</b> ; block to GND with a capacitor $C_{Q2} \geq 10 \mu\text{F}$ , ESR < 10 $\Omega$ at 10 kHz
14, 15, 16, 17	GND	<b>Ground</b>
18	I2	<b>Main regulator input voltage</b> ; block to GND directly at the IC with a ceramic capacitor
19	I1	<b>Stand-by regulator input voltage</b> ; block to GND directly at the IC with a ceramic capacitor
20	SI	<b>Sense comparator input</b>

## P-DSO-14-4

Pin No.	Symbol	Function
1	D	<b>Reset delay</b> ; connect a capacitor $C_D$ to GND for delay time adjustment
2	DIS	<b>Disable input main regulator</b> ; Q2 disabled with high signal
3, 4, 5	GND	<b>Ground</b>
6	RQ	<b>Reset output</b> ; the open collector output is connected to Q1 via an integrated 30 k $\Omega$ resistor
7	SQ	<b>Sense output</b> ; the open collector output is connected to Q1 via an integrated 30 k $\Omega$ resistor
8	Q1	<b>Stand-by regulator output voltage</b> ; block to GND with a capacitor, $C_{Q1} \geq 6 \mu\text{F}$ , ESR < 10 $\Omega$ at 10 kHz
9	Q2	<b>Main regulator output voltage</b> ; 5 V output tracking to Q1, block to GND with a capacitor $C_{Q2} \geq 10 \mu\text{F}$ , ESR < 10 $\Omega$ at 10 kHz
10, 11, 12	GND	<b>Ground</b>
13	I	<b>Main and stand-by regulator input voltage</b> ; block to GND directly at the IC with a ceramic capacitor
14	SI	<b>Sense comparator input</b>

RADJ Reset switching threshold adjust not available in P-DSO-14-4 package. Reset is always triggered at the internal threshold.

ADJ2 Main regulator adjust input is internally connected to  $V_{Q2}$

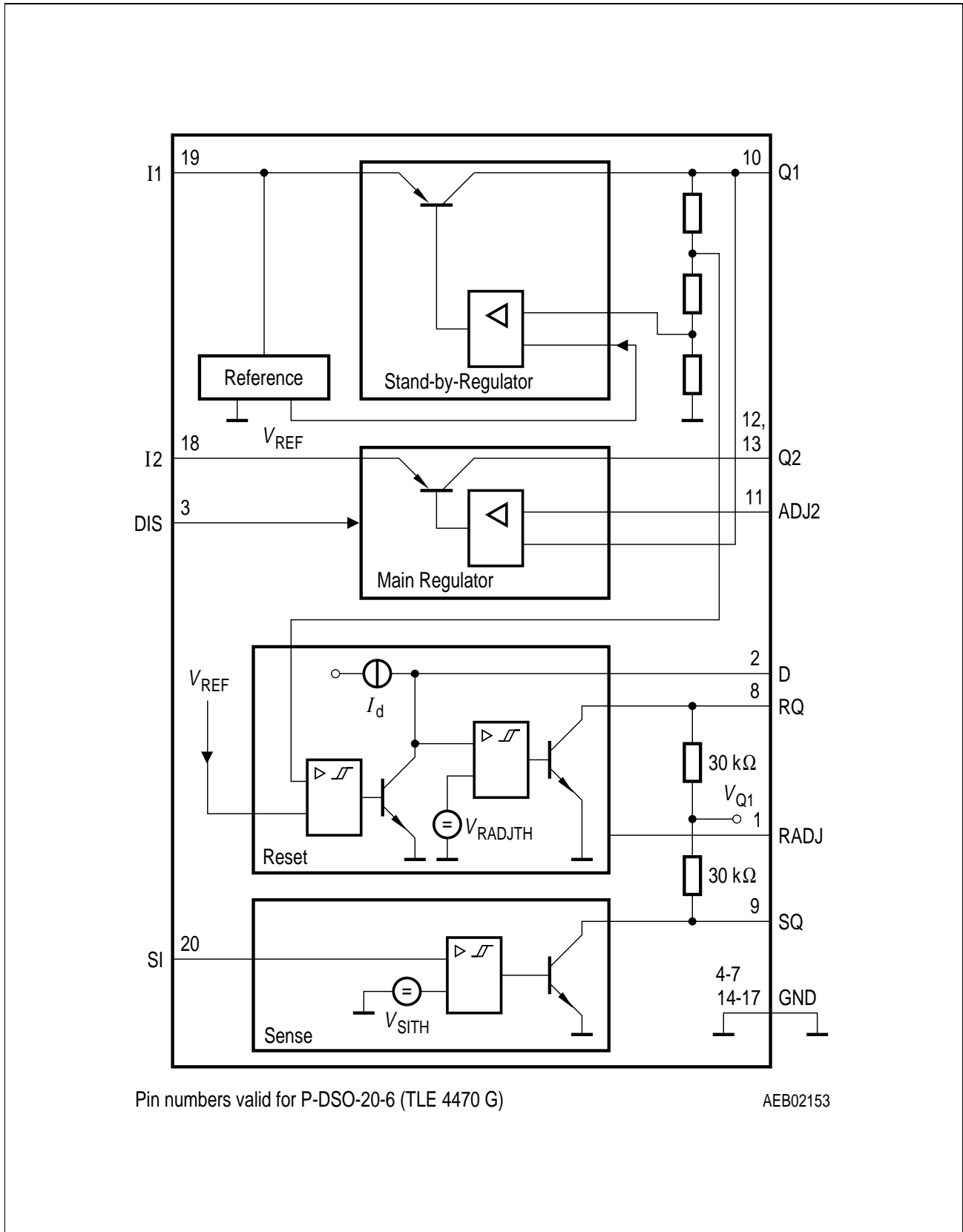

**Figure 2**  
**Block Diagram**

## Absolute Maximum Ratings

$-40\text{ °C} < T_j < 150\text{ °C}$

Parameter	Symbol	Limit Values		Unit	Remarks
		min.	max.		

### Stand-by Regulator Input Voltage $V_{I1}$

Voltage	$V_{I1}$	- 42	45	V	-
Current	$I_{I1}$	-	-	mA	Internally limited

### Main Regulator Input Voltage $V_{I2}$

Voltage	$V_{I2}$	- 42	45	V	-
Current	$I_{I2}$	-	-	mA	Internally limited

### Stand-by Output $V_{Q1}$

Voltage	$V_{Q1}$	- 1	7	V	-
Current	$I_{Q1}$	-	-	mA	Internally limited

### Main Output $V_{Q2}$

Voltage	$V_{Q2}$	- 1	36	V	-
Current	$I_{Q2}$	-	-	mA	Internally limited

### Main Regulator Adjust Input ADJ2

Voltage	$V_{ADJ2}$	- 0.3	18	V	-
Current	$I_{ADJ2}$	-	-	mA	Internally limited

### Sense Output SQ

Voltage	$V_{SQ}$	- 0.3	25	V	-
Current	$I_{SQ}$	- 5	5	mA	-

### Reset Output RQ

Voltage	$V_{RQ}$	- 0.3	25	V	-
Current	$I_{RQ}$	- 5	5	mA	-

**Absolute Maximum Ratings (cont'd)**

$-40\text{ °C} < T_j < 150\text{ °C}$

Parameter	Symbol	Limit Values		Unit	Remarks
		min.	max.		

**Disable Input DIS**

Voltage	$V_{DIS}$	- 42	45	V	-
Current	$I_{DIS}$	- 2	2	mA	-

**Sense Input SI**

Voltage	$V_{SI}$	- 25	18	V	-
Current	$I_{SI}$	- 2	2	mA	-

**Reset Delay D**

Voltage	$V_D$	- 0.3	7	V	-
Current	$I_D$	- 2	2	mA	-

**Reset Switching Threshold Adjust RADJ**

Voltage	$V_{RADJ}$	- 0.3	7	V	-
Current	$I_{RADJ}$	-	-	mA	Internally limited

**Temperatures**

Junction temperature	$T_j$	- 50	150	°C	-
Storage temperature	$T_{stg}$	- 50	150	°C	-

*Note: ESD-Protection according to MIL Std. 883:  $\pm 2\text{ kV}$ .*

*Maximum ratings are absolute ratings; exceeding any one of these values may cause irreversible damage to the integrated circuit.*

## Operating Range

Parameter	Symbol	Limit Values		Unit	Remarks
		min.	max.		
Stand-by regulator input voltage	$V_{I1}$	5.6	45	V	–
Main regulator input voltage	$V_{I2}$	$V_{Qnom} + 0.6\text{ V}$	45	V	–
Stand-by regulator output current	$I_{Q1}$	0	180	mA	–
Main regulator output current	$I_{Q2}$	0	350	mA	–
Disable input voltage	$V_{DIS}$	– 0.3	45	V	–
Sense input voltage	$V_{SI}$	– 0.3	17	V	–
Junction temperature	$T_j$	– 40	150	°C	–

## Thermal Resistances

Junction pin	$R_{thj-pin}$	–	25	K/W	Measured to pin 4
Junction ambient	$R_{thj-a}$	–	65	K/W	–

*Note: In the operating range the functions given in the circuit description are fulfilled.*



**Electrical Characteristics**

$V_{I1} = V_{I2} = 14 \text{ V}$ ;  $V_{DIS} < V_{DISL}$ ;  $-40 \text{ }^\circ\text{C} < T_j < 150 \text{ }^\circ\text{C}$ ; unless otherwise specified

Parameter	Symbol	Limit Values			Unit	Test Condition
		min.	typ.	max.		

**Stand-by Regulator**

**Output 1**

Output voltage	$V_{Q1}$	4.90	5.0	5.10	V	$1 \text{ mA} < I_{Q1} < 100 \text{ mA}$
Output current limitation	$I_{Q1}$	180	280	–	mA	see note 1
Output drop voltage; $V_{DRQ1} = V_{I1} - V_{Q1}$	$V_{DRQ1}$	–	300	500	mV	$I_{Q1} = 100 \text{ mA}$ ; see note 1

**Current Consumption**

Quiescent current; stand-by $I_q = I_{I1} - I_{Q1}$	$I_q$	–	180	250	$\mu\text{A}$	$I_{Q1} = 300 \mu\text{A}$ ; $T_j = 25 \text{ }^\circ\text{C}$ $V_{DIS} > V_{DISH}$
		–	180	300	$\mu\text{A}$	$I_{Q1} = 300 \mu\text{A}$ ; $V_{DIS} > V_{DISH}$
Quiescent current $I_q = I_{I1} - I_{Q1}$	$I_q$	–	4	6	mA	$I_{Q1} = 100 \text{ mA}$

**Regulator Performance**

Load regulation	$\Delta V_{Q1}$	–	15	50	mV	$1 \text{ mA} < I_{Q1} < 150 \text{ mA}$ ;
Load regulation	$\Delta V_{Q1}$	–	5	25	mV	$1 \text{ mA} < I_{Q1} < 100 \text{ mA}$ ;
Line regulation	$\Delta V_{Q1}$	–	5	20	mV	$I_{Q1} = 1 \text{ mA}$ ; $6 \text{ V} < V_{I1} < 28 \text{ V}$
Power-Supply-Ripple-Rejection	$PSRR$	–	60	–	dB	$20 \text{ Hz} < f_r < 20 \text{ kHz}$ ; $V_r = 5 V_{SS}$
Temperature output voltage drift	$\Delta V_{Q1}/\Delta T$	–	0.3	–	mV/K	–
$dV_{I1}/dt$ stability	$V_{Q1}$	4.5	–	5.5	V	no reset occurs; note 3
Value of output capacitance	$C_{Q1}$	6	–	–	$\mu\text{F}$	–
ESR of output capacitance	$R_{ESRQ1}$	–	–	10	$\Omega$	at 10 kHz

**Electrical Characteristics (cont'd)**

$V_{I1} = V_{I2} = 14 \text{ V}$ ;  $V_{DIS} < V_{DISL}$ ;  $-40 \text{ }^\circ\text{C} < T_j < 150 \text{ }^\circ\text{C}$ ; unless otherwise specified

Parameter	Symbol	Limit Values			Unit	Test Condition
		min.	typ.	max.		

**Main-Regulator**

**Output 2**

Output voltage tracking accuracy	$V_{Q2} - V_{Q1}$	- 25	5	25	mV	$5 \text{ mA} < I_{Q2} < 100 \text{ mA}$ ; $6 \text{ V} < V_{I2} < 40 \text{ V}$
Output voltage tracking accuracy	$V_{Q2} - V_{Q1}$	- 25	5	25	mV	$5 \text{ mA} < I_{Q2} < 250 \text{ mA}$ ; $7 \text{ V} < V_{I2} < 28 \text{ V}$ see note 2
Adjust input current	$I_{ADJ2}$	- 1	-	1	$\mu\text{A}$	-
Output current limitation	$I_{Q2}$	350	500	-	mA	see note 1
Output drop voltage $V_{DRQ2} = V_{I2} - V_{Q2}$	$V_{DRQ2}$	-	300	600	mV	$I_{Q2} = 200 \text{ mA}$ ; see note 1

**Current Consumption**

Quiescent current; $I_q = I_1 - I_Q$	$I_q$	-	7	15	mA	$I_{Q2} = 200 \text{ mA}$ $I_{Q1} = 300 \mu\text{A}$
Quiescent current; $I_q = I_1 - I_Q$	$I_q$	-	250	500	$\mu\text{A}$	$I_{Q2} = I_{Q1} = 300 \mu\text{A}$ ; $T_j = 25 \text{ }^\circ\text{C}$

**Regulator Performance**

Load regulation	$\Delta V_{Q2}$	-	5	25	mV	$5 \text{ mA} < I_{Q2} < 200 \text{ mA}$ ;
Line regulation	$\Delta V_{Q2}$	-	5	20	mV	$I_{Q2} = 5 \text{ mA}$ ; $6 \text{ V} < V_{I2} < 28 \text{ V}$
Power-Supply-Ripple-Rejection	$PSRR$	-	60	-	dB	$20 \text{ Hz} < f_r < 20 \text{ kHz}$ ; $V_r = 5 \text{ V}_{SS}$
Temperature output voltage drift	$\Delta V_{Q2}/\Delta T$	-	0.5	-	mV/K	-
$dV_{I2}/dt$ stability	$V_{Q2}$	4.5	-	5.5	V	no reset occurs; note 2
Value of output capacitance	$C_{Q2}$	10	-	-	$\mu\text{F}$	-

**Electrical Characteristics (cont'd)**

$V_{I1} = V_{I2} = 14 \text{ V}$ ;  $V_{DIS} < V_{DISL}$ ;  $-40 \text{ }^\circ\text{C} < T_j < 150 \text{ }^\circ\text{C}$ ; unless otherwise specified

Parameter	Symbol	Limit Values			Unit	Test Condition
		min.	typ.	max.		
ESR of output capacitance	$R_{ESRQ2}$	–	–	10	$\Omega$	at 10 kHz

**Disable Input DIS**

H-input voltage threshold	$V_{DISH}$	1.8	2.0	2.3	V	–
L-input voltage threshold	$V_{DISL}$	1.4	1.7	2.0	V	Output 2 active
H-input current	$I_{DISH}$	– 2	– 1	1	$\mu\text{A}$	$2.3 \text{ V} < V_{DIS} < 7 \text{ V}$
L-input current	$I_{DISL}$	– 6	– 2	– 0.5	$\mu\text{A}$	$0 \text{ V} < V_{DIS} < 1.4 \text{ V}$

**Reset Timing D and Output RQ**

Reset switching threshold	$V_{RT}$	4.5	4.65	4.8	V	RADJ connected to GND
Reset adjust threshold	$V_{RADJTH}$	1.25	1.35	1.45	V	$V_{Q1} > 3.5 \text{ V}$
Reset output low voltage	$V_{RQL}$	–	0.15	0.3	V	$R_{RQ} = 10 \text{ k}\Omega$ external connected to $V_{Q1}$ ; $V_{Q1} \geq 1 \text{ V}$
Reset high voltage	$V_{RQH}$	4.5	–	–	V	–
Reset pull up resistor	$R_{RQ}$	20	30	45	$\text{k}\Omega$	Internal connected to $V_{Q1}$
Reset charging current	$I_d$	3	5	9	$\mu\text{A}$	$V_D = 1 \text{ V}$
Upper timing threshold	$V_{DU}$	1.5	1.8	2.2	V	–
Lower timing threshold	$V_{DL}$	0.3	0.4	0.55	V	–
Reset delay time	$t_d$	12	15	20	ms	$C_D = 47 \text{ nF}$
Reset reaction time	$t_{RR}$	–	0.5	2.0	$\mu\text{s}$	$C_D = 47 \text{ nF}$

**Electrical Characteristics (cont'd)**

$V_{I1} = V_{I2} = 14 \text{ V}$ ;  $V_{DIS} < V_{DISL}$ ;  $-40 \text{ }^\circ\text{C} < T_j < 150 \text{ }^\circ\text{C}$ ; unless otherwise specified

Parameter	Symbol	Limit Values			Unit	Test Condition
		min.	typ.	max.		

**Sense Input SI and Output SQ**

Sense threshold voltage	$V_{SITH}$	1.28	1.35	1.45	V	$V_{SI}$ decreasing
Sense threshold hysteresis	$V_{SIHY}$	25	60	100	mV	–
Sense output low voltage	$V_{SQL}$	–	0.15	0.4	V	$R_{SQ} = 10 \text{ k}\Omega$ external connected to $V_{Q1}$ $V_{SI} = 1.1 \text{ V}$ ; $V_{I1} > 4.5 \text{ V}$
Sense output high voltage	$V_{SQH}$	4.5	–	–	V	$V_{SI} > 1.5 \text{ V}$
Sense pull up resistor	$R_{SQ}$	20	30	45	k $\Omega$	Internal connected to $V_{Q1}$

*Note 1: Measured when the output voltage  $V_Q$  has dropped 100 mV from the nominal value.*

*Note 2:  $V_{Q2}$  connected to ADJ2*

*Note 3: Square wave at  $V_1$ : 8 V to 18 V;  $f = 10 \text{ kHz}$ ;  $t_r = t_f \leq 100 \text{ ns}$*

Application Information

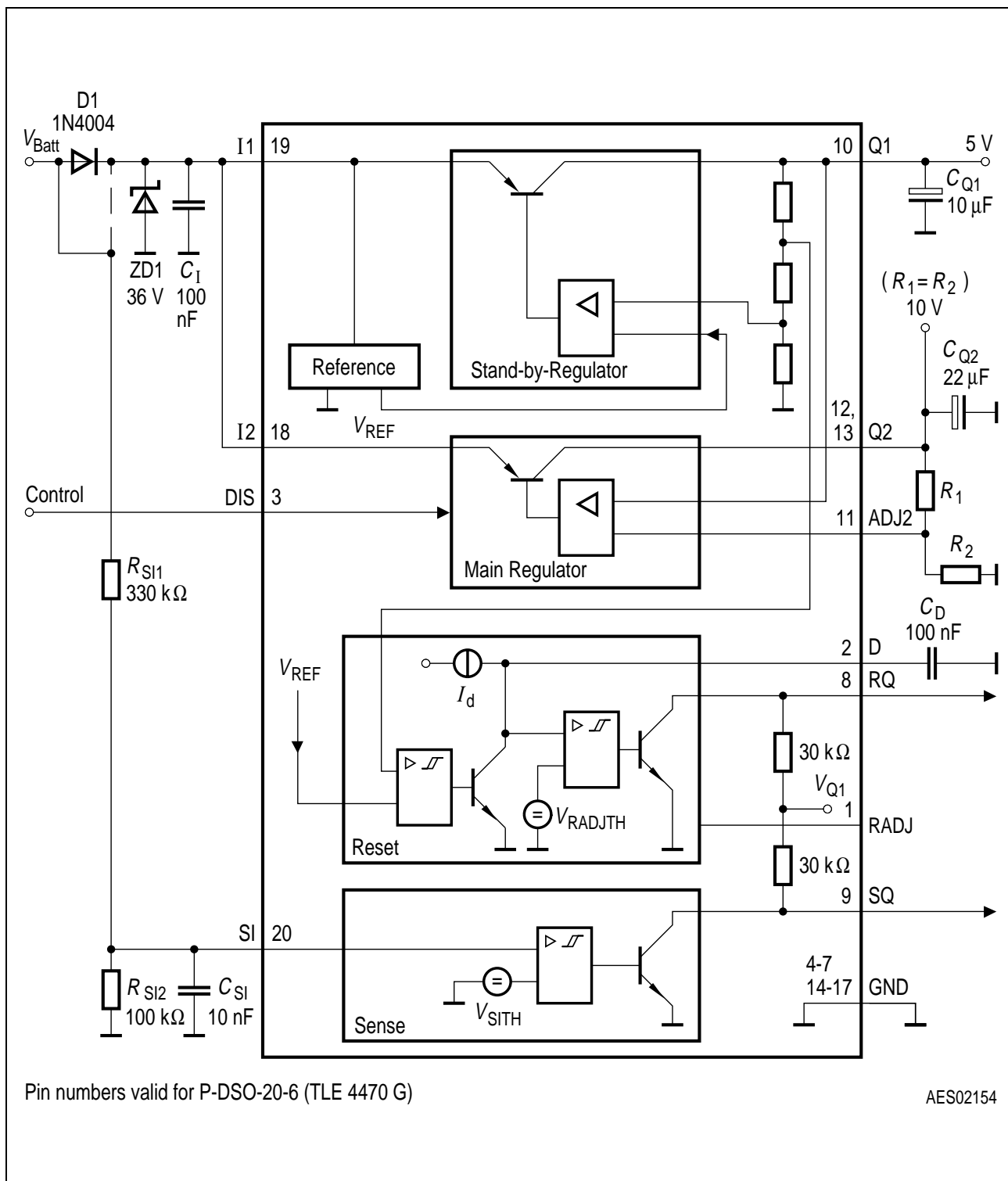

Figure 3  
Application Circuit

### Input, Output

The input capacitor  $C_1$  is necessary for compensating line influences. Using a resistor of approx.  $1 \Omega$  in series with  $C_1$ , the LC circuit of input inductivity and input capacitance can be damped. To stabilize the regulation circuits of the stand-by and main regulator, output capacitors  $C_{Q1}$  and  $C_{Q2}$  are necessary. Stability is guaranteed at values  $C_{Q1} \geq 6 \mu\text{F}$  &  $C_{Q2} \geq 10 \mu\text{F}$ , both with an ESR  $\leq 10 \Omega$  within the operating temperature range.

For the TLE 4470 G (P-DSO-20-6) the output voltage  $V_{Q2}$  of the main regulator can be adjusted to  $5 \text{ V} \leq V_{Q2\text{rated}} \leq 20 \text{ V}$  by connecting an external voltage divider to the voltage adjust pin VA. For  $V_{Q2} = 5 \text{ V}$  the voltage adjust pin has to be connected directly to the main output.

For calculating  $V_Q$  or  $R_1$  &  $R_2$  respectively the following equations can be used:

$$V_Q = V_{\text{ref}} \times (R_1 + R_2) / R_2$$

or

$$R_1 = R \times (V_Q / V_{\text{ref}})$$

$$R_2 = R \times R_1 / (R_1 - R)$$

Definitions:  $R = R_1 // R_2$ ;  $R \approx 100 \text{ k}\Omega$

$V_{\text{ref}}$  = Output voltage of stand by regulator, typical  $5 \text{ V}$

### Disable

The main regulator of the TLE 4470 can be switched OFF by a voltage of  $2.3 \text{ V}$  at pin DIS. Reducing this voltage below  $1.4 \text{ V}$  will switch ON the main regulator again.

### Reset Timing

The power-on reset delay time is defined by the charging time of an external capacitor  $C_d$  which can be calculated as follows:

$$C_d = (\Delta t_d \times I_d) / \Delta V$$

Definitions:  $C_d$  = delay capacitor

$\Delta t_d$  = delay time

$I_d$  = charge current, typical  $5 \mu\text{A}$

$\Delta V = V_{\text{dt}}$ , typical  $1.8 \text{ V}$

$V_{\text{dt}}$  = upper delay switching threshold at  $C_d$  for reset delay time

The reset reaction time  $t_{\text{rr}}$  is the time it takes the voltage regulator to set the reset out LOW after the output voltage has dropped below the reset threshold. It is typically  $2 \mu\text{s}$  for delay capacitor of  $100 \text{ nF}$ . For other values for  $C_d$  the reaction time can be estimated using the following equation:

$$t_{\text{rr}} \approx 20 \text{ s/F} \times C_d$$

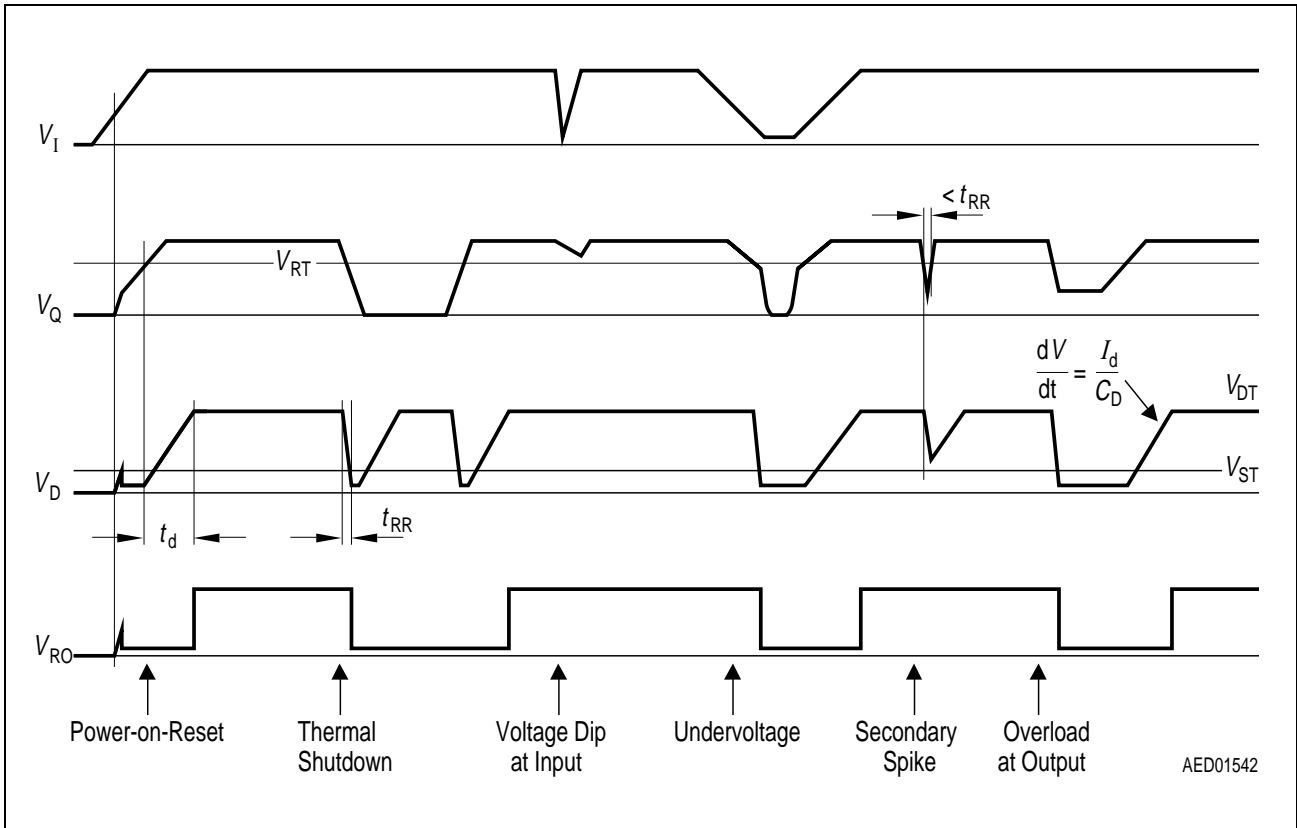

**Figure 4**  
**Reset Timing**

**Reset Switching Threshold**

The internally set reset threshold is 4.65 V. When using the TLE 4470 G (P-DSO-20-6) this threshold can be adjusted to  $3.5\text{ V} < V_{RTH} < 4.6\text{ V}$  by connecting an external voltage divider to pin RADJ. If this pin is not needed, it can be left open or even better connected to GND.

$$R_1 = R_2 \times (V_{RT} - V_{ref}) / V_{ref}$$

Definitions:  $V_{RT}$  = Reset threshold  
 $V_{ref}$  = comparator reference voltage, typical 1.35 V  
 (Reset adjust input current  $\approx 50\text{ nA}$ )

The reset output pin is internally connected to the stand-by output Q1 via a 30 kΩ pull-up resistor. The reset LOW signal at pin RQ is guaranteed down to an output voltage  $V_{Q1}$  of 1 V typical.





Typical Performance Characteristics

Drop Voltage  $V_{dr}$  versus Output 1 Current  $I_{Q1}$

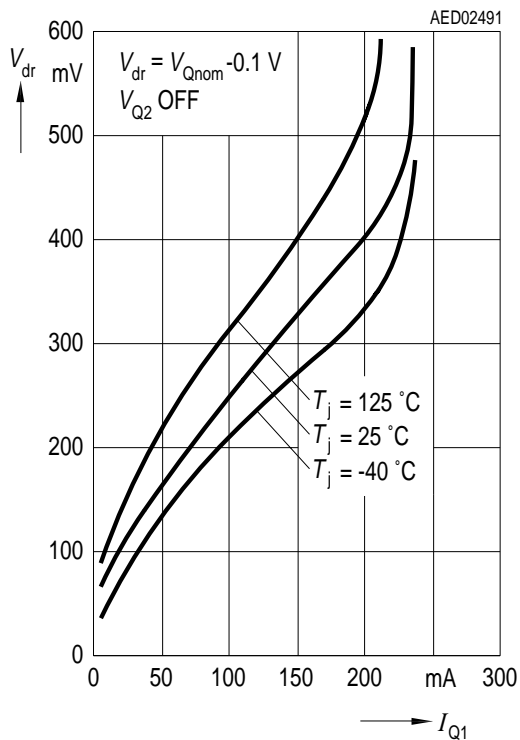

Output Voltage  $V_{Q1}/V_{Q2}$  versus Output Current  $I_{Q1}$

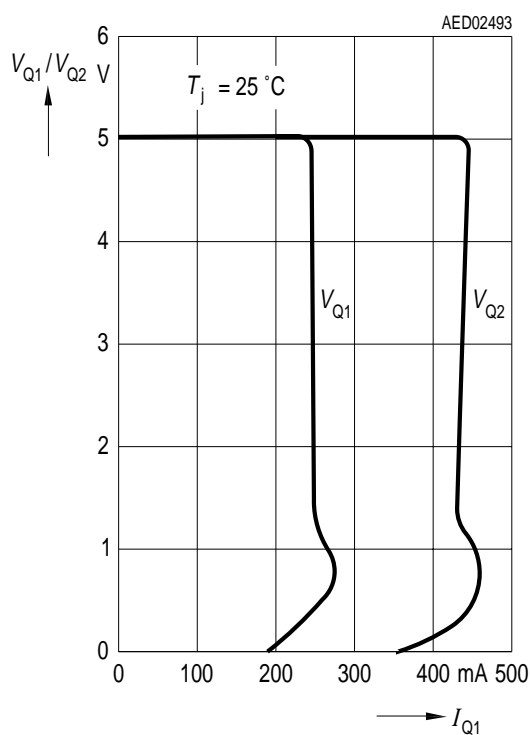

Drop Voltage  $V_{dr}$  versus Output 2 Current  $I_{Q2}$

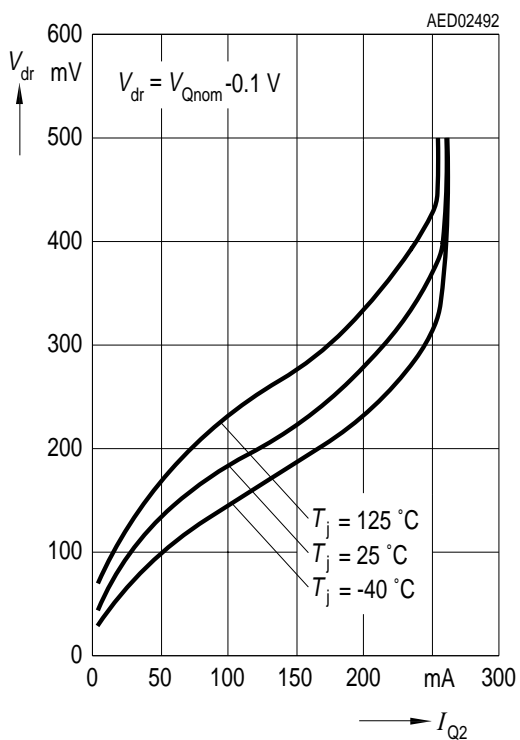

Output 1 Voltage  $V_{Q1}$  versus Temperature  $T_j$

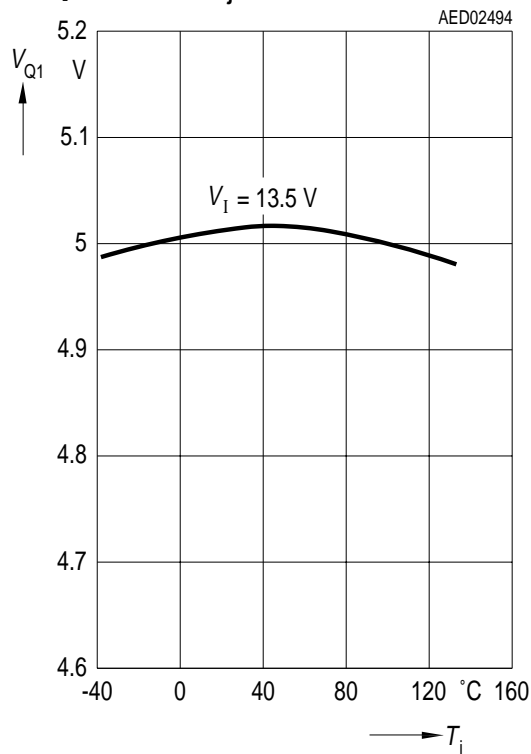

**Output Voltage  $V_{Q1}$ ,  $V_{Q2}$  versus Input Voltage  $V_I$  ( $V_{I1} = V_{I2}$ )**

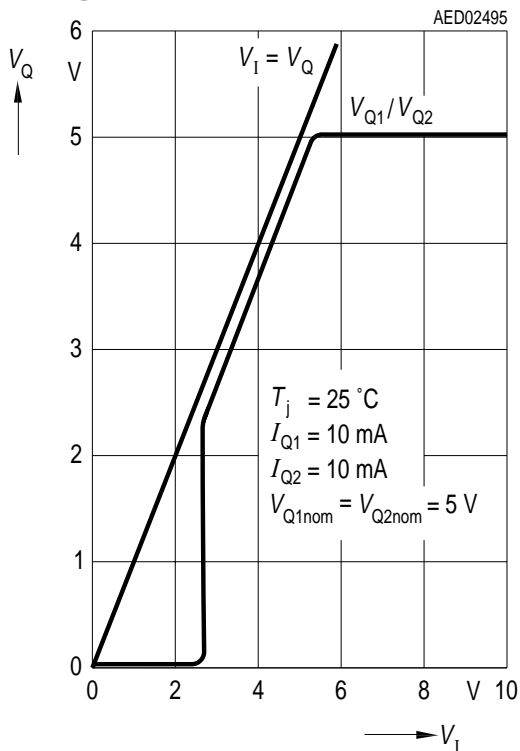

**Current Consumption  $I_q$  versus Output 1 Current  $I_{Q1}$  (low load)**

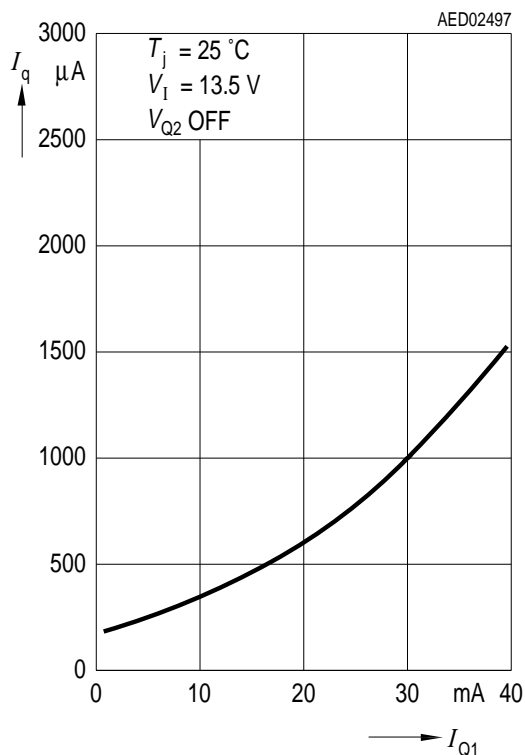

**Current Consumption  $I_q$  versus Input Voltage  $V_I$**

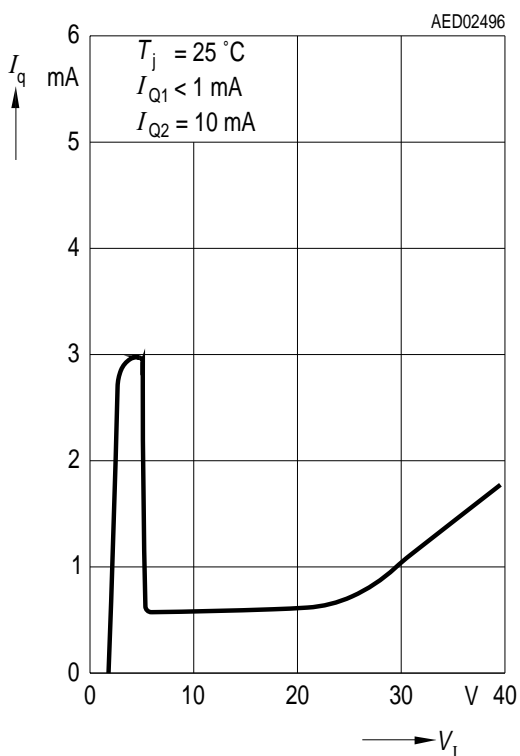

**Current Consumption  $I_q$  versus Output 1 Current  $I_{Q1}$  (high load)**

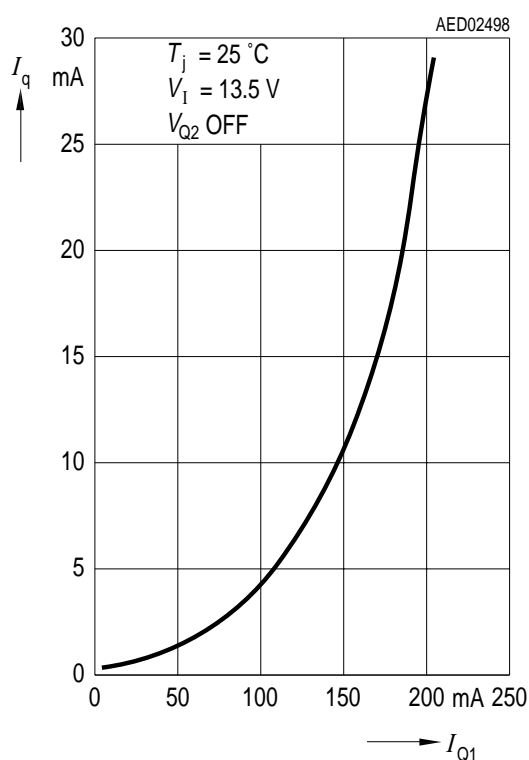

**Current Consumption  $I_q$  versus Output 2 Current  $I_{Q2}$  (low load)**

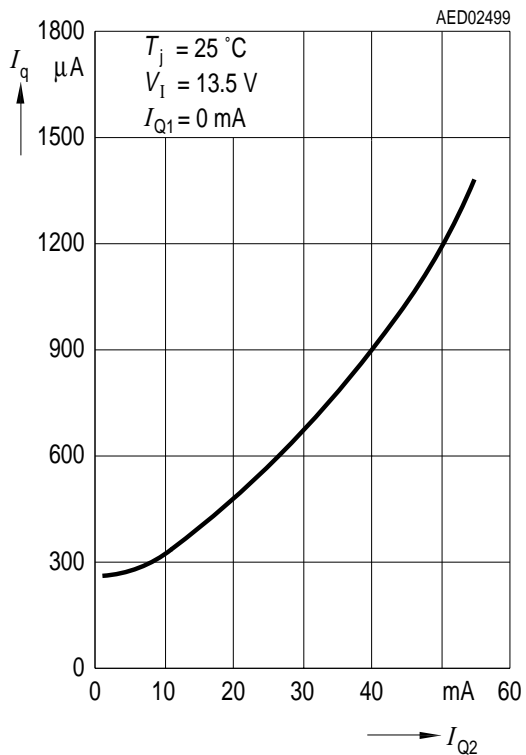

**Reset Adjust Threshold  $V_{RADJTH}$  versus Temperature  $T_j$**

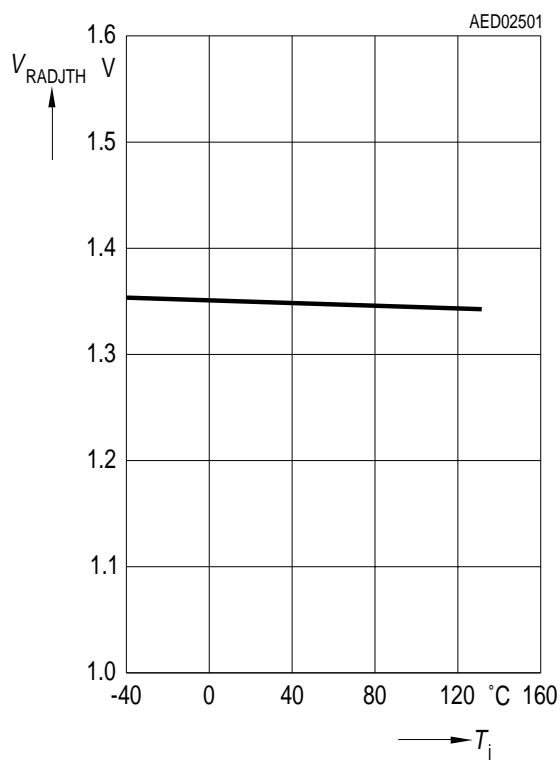

**Current Consumption  $I_q$  versus Output 2 Current  $I_{Q2}$  (high load)**

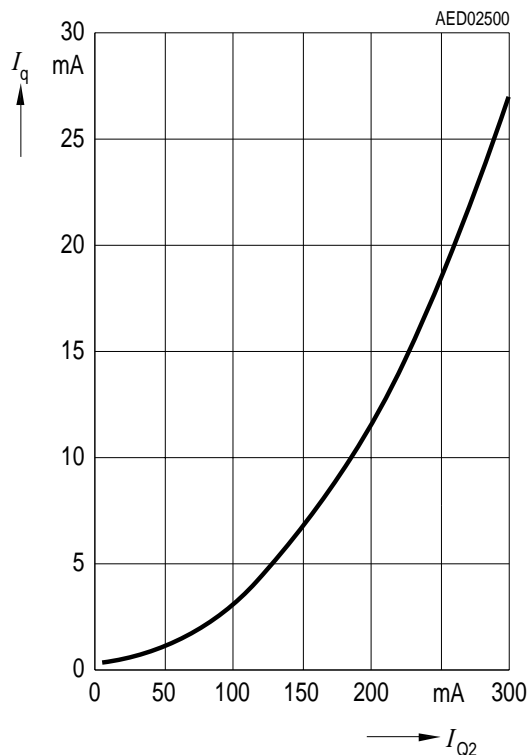

**Switching Voltage  $V_{DU}$ ,  $V_{DL}$  versus Temperature  $T_j$**

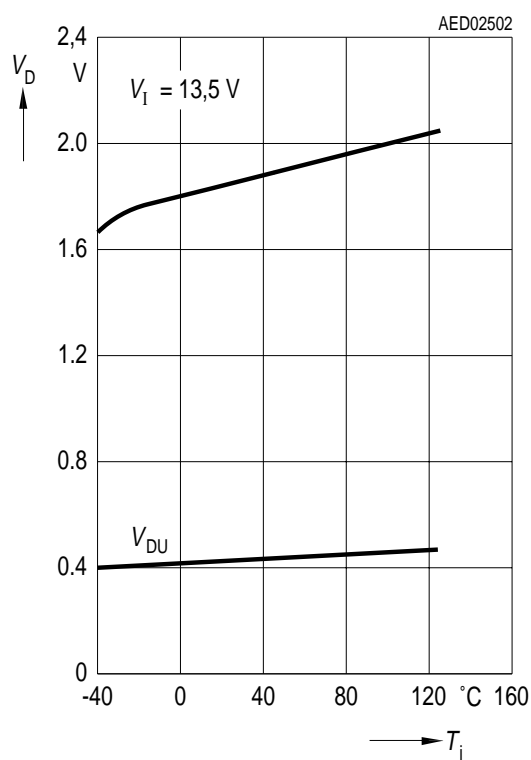

Charge Current  $I_d$  versus Temperature  $T_j$

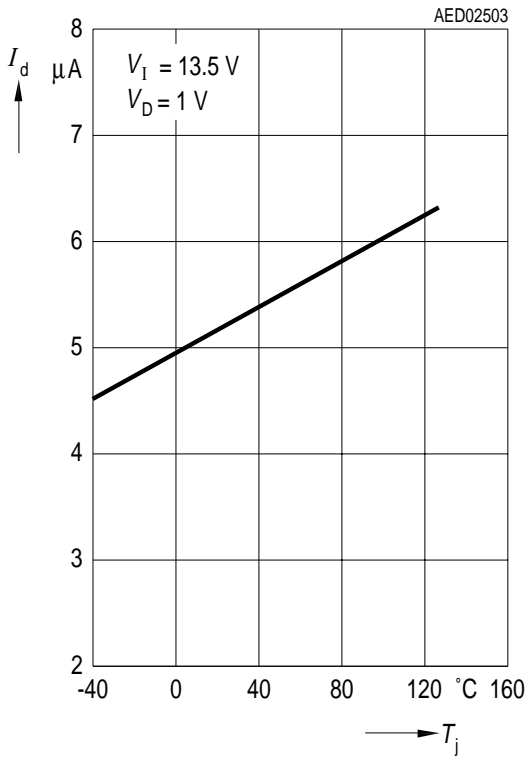

Sense Threshold  $V_{SITH}$  versus Temperature  $T_j$

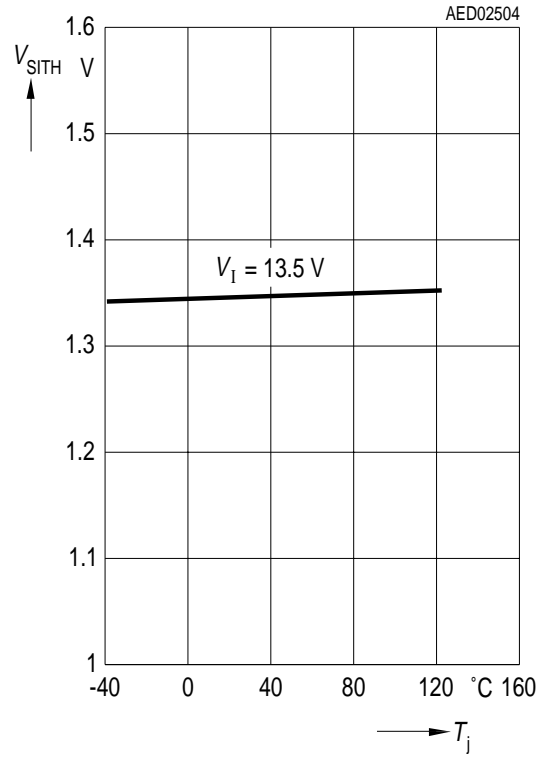

Package Outlines

**P-DSO-14-4**  
(Plastic Dual Small Outline)

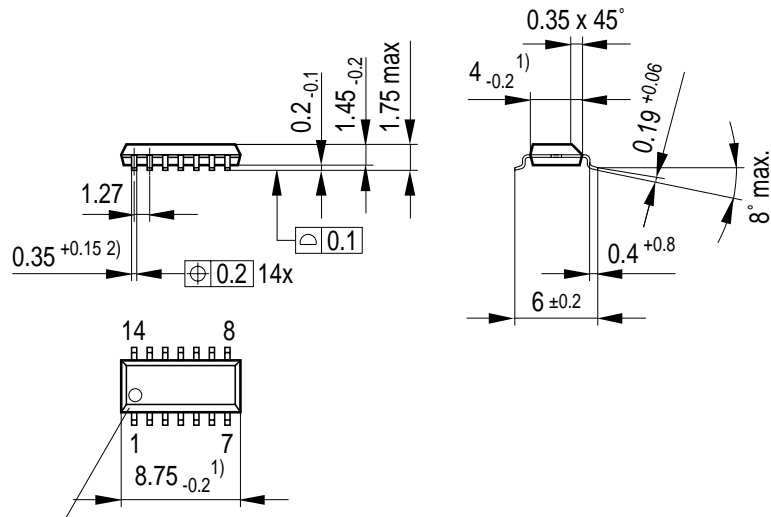

Index Marking

- 1) Does not include plastic or metal protrusion of 0.15 max. per side
- 2) Does not include dambar protrusion of 0.05 max. per side

GPS05093

**Sorts of Packing**

Package outlines for tubes, trays etc. are contained in our Data Book "Package Information".

**SMD = Surface Mounted Device**

Dimensions in mm

**P-DSO-20-6**  
(Plastic Dual Small Outline)

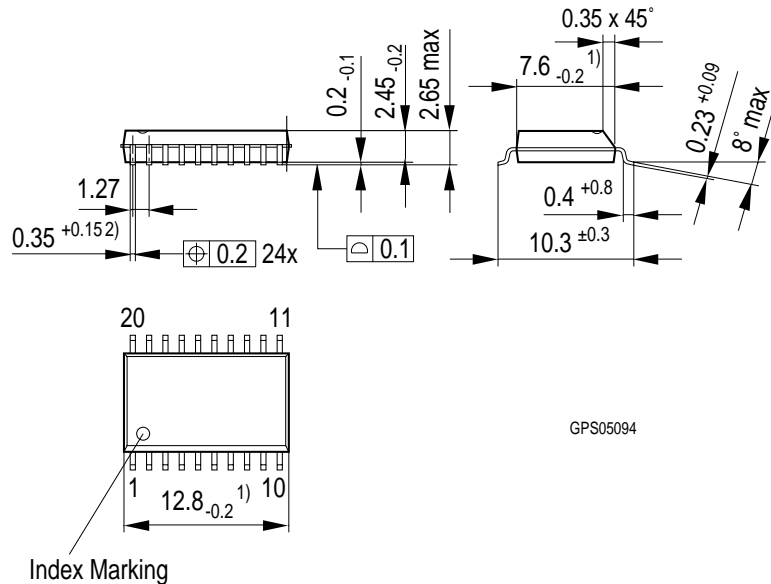

GPS05094

- 1) Does not include plastic or metal protrusions of 0.15 max per side
- 2) Does not include dambar protrusion of 0.05 max per side

**Sorts of Packing**

Package outlines for tubes, trays etc. are contained in our Data Book "Package Information".

**SMD = Surface Mounted Device**

Dimensions in mm