



# VNN7NV04 / VNS7NV04 VND7NV04 / VND7NV04-1

## “OMNIFET II”: FULLY AUTOPROTECTED POWER MOSFET

TYPE	$R_{DS(on)}$	$I_{lim}$	$V_{clamp}$
VNN7NV04	60 mΩ	6 A	40 V
VNS7NV04			
VND7NV04			
VND7NV04-1			

- LINEAR CURRENT LIMITATION
- THERMAL SHUT DOWN
- SHORT CIRCUIT PROTECTION
- INTEGRATED CLAMP
- LOW CURRENT DRAWN FROM INPUT PIN
- DIAGNOSTIC FEEDBACK THROUGH INPUT PIN
- ESD PROTECTION
- DIRECT ACCESS TO THE GATE OF THE POWER MOSFET (ANALOG DRIVING)
- COMPATIBLE WITH STANDARD POWER MOSFET

### DESCRIPTION

The VNN7NV04, VNS7NV04, VND7NV04 VND7NV04-1, are monolithic devices designed in STMicroelectronics VIPower M0-3 Technology, intended for replacement of standard Power

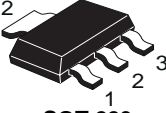

SOT-223

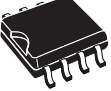

SO-8

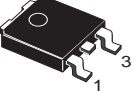

TO252 (DPAK)

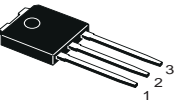

TO251 (IPAK)

ORDER CODES		
PACKAGE	TUBE	T&R
SOT-223	VNN7NV04	VNN7NV0413TR
SO-8	VNS7NV04	VNS7NV0413TR
TO-252 (DPAK)	VND7NV04	VND7NV0413TR
TO-251 (IPAK)	VND7NV04-1	-

MOSFETS from DC up to 50KHz applications. Built in thermal shutdown, linear current limitation and overvoltage clamp protects the chip in harsh environments.

Fault feedback can be detected by monitoring the voltage at the input pin.

### BLOCK DIAGRAM

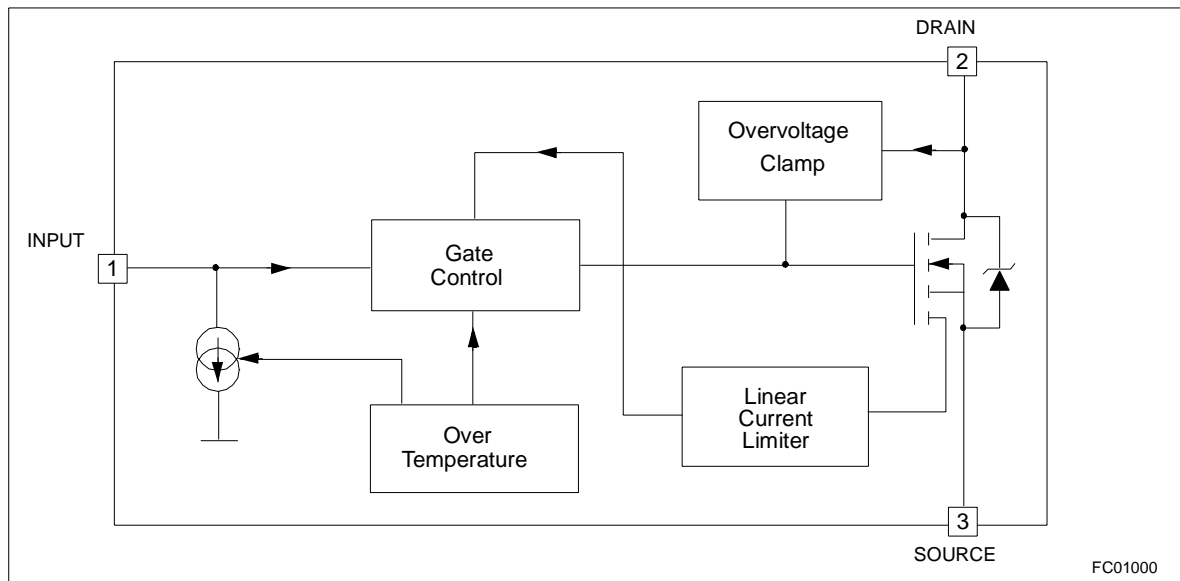

**ABSOLUTE MAXIMUM RATING**

Symbol	Parameter	Value			Unit
		SOT-223	SO-8	DPAK/IPAK	
$V_{DS}$	Drain-source Voltage ( $V_{IN}=0V$ )	Internally Clamped			V
$V_{IN}$	Input Voltage	Internally Clamped			V
$I_{IN}$	Input Current	+/-20			mA
$R_{IN\ MIN}$	Minimum Input Series Impedance	150			$\Omega$
$I_D$	Drain Current	Internally Limited			A
$I_R$	Reverse DC Output Current	-10.5			A
$V_{ESD1}$	Electrostatic Discharge ( $R=1.5K\Omega$ , $C=100pF$ )	4000			V
$V_{ESD2}$	Electrostatic Discharge on output pin only ( $R=330\Omega$ , $C=150pF$ )	16500			V
$P_{tot}$	Total Dissipation at $T_c=25^\circ C$	7	4.6	60	W
$E_{MAX}$	Maximum Switching Energy ( $L=0.7mH$ ; $R_L=0\Omega$ ; $V_{bat}=13.5V$ ; $T_{jstart}=150^\circ C$ ; $I_L=9A$ )	40		40	mJ
$E_{MAX}$	Maximum Switching Energy ( $L=0.6mH$ ; $R_L=0\Omega$ ; $V_{bat}=13.5V$ ; $T_{jstart}=150^\circ C$ ; $I_L=9A$ )		37		mJ
$T_j$	Operating Junction Temperature	Internally limited			$^\circ C$
$T_c$	Case Operating Temperature	Internally limited			$^\circ C$
$T_{stg}$	Storage Temperature	-55 to 150			$^\circ C$

**CONNECTION DIAGRAM (TOP VIEW)**

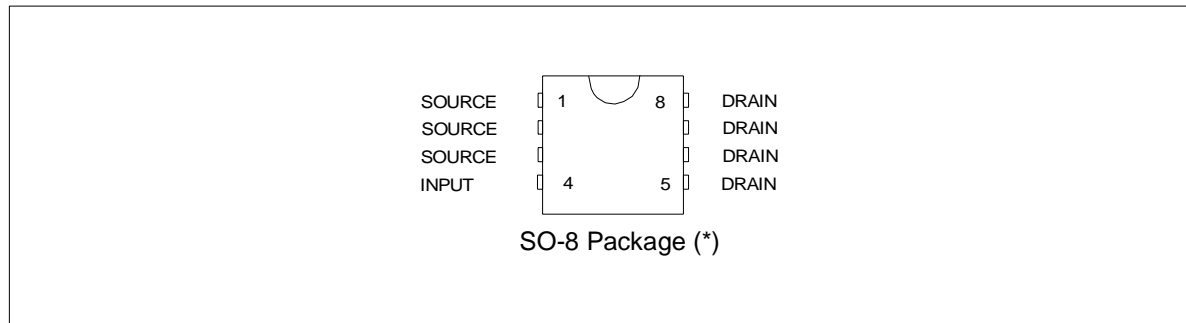

(\*) For the pins configuration related to SOT-223, DPAK, IPAK see outlines at page 1.

**CURRENT AND VOLTAGE CONVENTIONS**

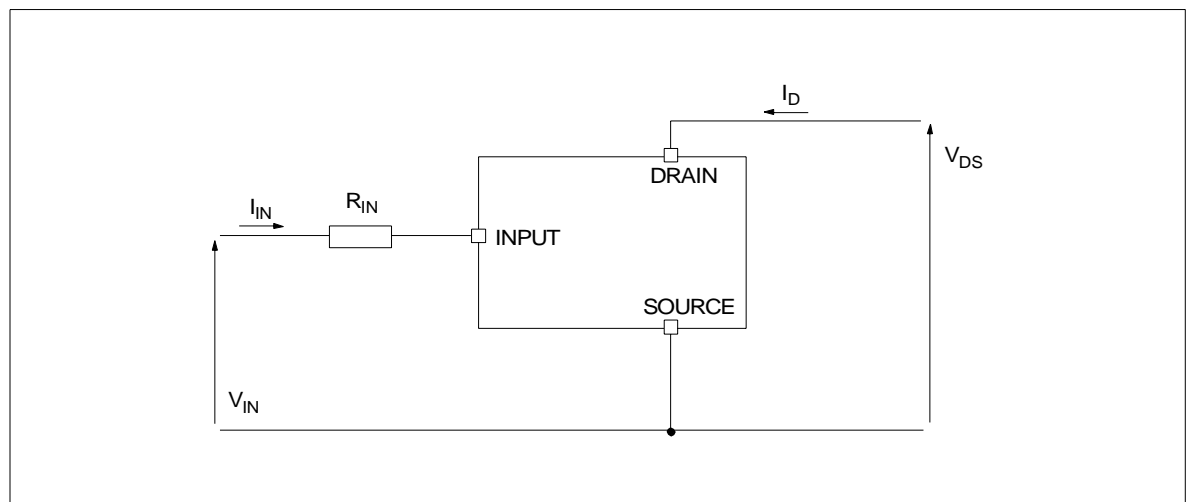

**THERMAL DATA**

Symbol	Parameter	Value				Unit
		SOT-223	SO-8	DPAK	IPAK	
R <sub>thj-case</sub>	Thermal Resistance Junction-case MAX	18		2.1	2.1	°C/W
R <sub>thj-lead</sub>	Thermal Resistance Junction-lead MAX		27			°C/W
R <sub>thj-amb</sub>	Thermal Resistance Junction-ambient MAX	96 (*)	90 (*)	65 (*)	102	°C/W

(\*) When mounted on a standard single-sided FR4 board with 0.5cm<sup>2</sup> of Cu (at least 35 μm thick) connected to all DRAIN pins.

**ELECTRICAL CHARACTERISTICS (-40°C < T<sub>j</sub> < 150°C, unless otherwise specified)**

**OFF**

Symbol	Parameter	Test Conditions	Min	Typ	Max	Unit
V <sub>CLAMP</sub>	Drain-source Clamp Voltage	V <sub>IN</sub> =0V; I <sub>D</sub> =3.5A	40	45	55	V
V <sub>CLTH</sub>	Drain-source Clamp Threshold Voltage	V <sub>IN</sub> =0V; I <sub>D</sub> =2mA	36			V
V <sub>INTH</sub>	Input Threshold Voltage	V <sub>DS</sub> =V <sub>IN</sub> ; I <sub>D</sub> =1mA	0.5		2.5	V
I <sub>ISS</sub>	Supply Current from Input Pin	V <sub>DS</sub> =0V; V <sub>IN</sub> =5V		100	150	μA
V <sub>INCL</sub>	Input-Source Clamp Voltage	I <sub>IN</sub> =1mA I <sub>IN</sub> =-1mA	6 -1.0	6.8	8 -0.3	V
I <sub>DSS</sub>	Zero Input Voltage Drain Current (V <sub>IN</sub> =0V)	V <sub>DS</sub> =13V; V <sub>IN</sub> =0V; T <sub>j</sub> =25°C V <sub>DS</sub> =25V; V <sub>IN</sub> =0V			30 75	μA

**ON**

Symbol	Parameter	Test Conditions	Min	Typ	Max	Unit
R <sub>DS(on)</sub>	Static Drain-source On Resistance	V <sub>IN</sub> =5V; I <sub>D</sub> =3.5A; T <sub>j</sub> =25°C V <sub>IN</sub> =5V; I <sub>D</sub> =3.5A			60 120	mΩ

## VNN7NV04 / VNS7NV04 / VND7NV04 / VND7NV04-1

### ELECTRICAL CHARACTERISTICS (continued) ( $T_j=25^\circ\text{C}$ , unless otherwise specified)

#### DYNAMIC

Symbol	Parameter	Test Conditions	Min	Typ	Max	Unit
$g_{fs}^*$	Forward Transconductance	$V_{DD}=13\text{V}; I_D=3.5\text{A}$		9		S
$C_{OSS}$	Output Capacitance	$V_{DS}=13\text{V}; f=1\text{MHz}; V_{IN}=0\text{V}$		220		pF

#### SWITCHING

Symbol	Parameter	Test Conditions	Min	Typ	Max	Unit
$t_{d(on)}$	Turn-on Delay Time	$V_{DD}=15\text{V}; I_D=3.5\text{A}$		100	300	ns
$t_r$	Rise Time			470	1500	ns
$t_{d(off)}$	Turn-off Delay Time	$V_{gen}=5\text{V}; R_{gen}=R_{IN\ MIN}=150\Omega$ (see figure 1)		500	1500	ns
$t_f$	Fall Time			350	1000	ns
$t_{d(on)}$	Turn-on Delay Time	$V_{DD}=15\text{V}; I_D=3.5\text{A}$		0.75	2.3	$\mu\text{s}$
$t_r$	Rise Time			4.6	14.0	$\mu\text{s}$
$t_{d(off)}$	Turn-off Delay Time	$V_{gen}=5\text{V}; R_{gen}=2.2\text{K}\Omega$ (see figure 1)		5.4	16.0	$\mu\text{s}$
$t_f$	Fall Time			3.6	11.0	$\mu\text{s}$
$(di/dt)_{on}$	Turn-on Current Slope	$V_{DD}=15\text{V}; I_D=3.5\text{A}$ $V_{gen}=5\text{V}; R_{gen}=R_{IN\ MIN}=150\Omega$		6.5		A/ $\mu\text{s}$
$Q_i$	Total Input Charge	$V_{DD}=12\text{V}; I_D=3.5\text{A}; V_{IN}=5\text{V}$ $I_{gen}=2.13\text{mA}$ (see figure 5)		18		nC

#### SOURCE DRAIN DIODE

Symbol	Parameter	Test Conditions	Min	Typ	Max	Unit
$V_{SD}^*$	Forward On Voltage	$I_{SD}=3.5\text{A}; V_{IN}=0\text{V}$		0.8		V
$t_{rr}$	Reverse Recovery Time	$I_{SD}=3.5\text{A}; di/dt=20\text{A}/\mu\text{s}$		220		ns
$Q_{rr}$	Reverse Recovery Charge	$V_{DD}=30\text{V}; L=200\mu\text{H}$		0.28		$\mu\text{C}$
$I_{RRM}$	Reverse Recovery Current	(see test circuit, figure 2)		2.5		A

#### PROTECTIONS ( $-40^\circ\text{C} < T_j < 150^\circ\text{C}$ , unless otherwise specified)

Symbol	Parameter	Test Conditions	Min	Typ	Max	Unit
$I_{lim}$	Drain Current Limit	$V_{IN}=5\text{V}; V_{DS}=13\text{V}$	6	9	12	A
$t_{dlim}$	Step Response Current Limit	$V_{IN}=5\text{V}; V_{DS}=13\text{V}$		4.0		$\mu\text{s}$
$T_{jsh}$	Overtemperature Shutdown		150	175	200	$^\circ\text{C}$
$T_{jrs}$	Overtemperature Reset		135			$^\circ\text{C}$
$I_{gf}$	Fault Sink Current	$V_{IN}=5\text{V}; V_{DS}=13\text{V}; T_j=T_{jsh}$		15		mA
$E_{as}$	Single Pulse Avalanche Energy	starting $T_j=25^\circ\text{C}; V_{DD}=24\text{V}$ $V_{IN}=5\text{V}; R_{gen}=R_{IN\ MIN}=150\Omega; L=24\text{mH}$ (see figures 3 & 4)	200			mJ

(\*) Pulsed: Pulse duration = 300 $\mu\text{s}$ , duty cycle 1.5%

## PROTECTION FEATURES

During normal operation, the INPUT pin is electrically connected to the gate of the internal power MOSFET through a low impedance path.

The device then behaves like a standard power MOSFET and can be used as a switch from DC to 50KHz. The only difference from the user's standpoint is that a small DC current  $I_{SS}$  (typ. 100 $\mu$ A) flows into the INPUT pin in order to supply the internal circuitry.

The device integrates:

- **OVERVOLTAGE CLAMP PROTECTION:** internally set at 45V, along with the rugged avalanche characteristics of the Power MOSFET stage give this device unrivalled ruggedness and energy handling capability. This feature is mainly important when driving inductive loads.

- **LINEAR CURRENT LIMITER CIRCUIT:** limits the drain current  $I_D$  to  $I_{lim}$  whatever the INPUT pin voltage. When the current limiter is active, the device operates in the linear region, so power dissipation may exceed the capability of the heatsink. Both case and junction temperatures increase, and if this phase lasts long enough, junction temperature may reach the overtemperature threshold  $T_{jsh}$ .

- **OVERTEMPERATURE AND SHORT CIRCUIT PROTECTION:** these are based on sensing the chip temperature and are not dependent on the input voltage. The location of the sensing element on the chip in the power stage area ensures fast, accurate detection of the junction temperature. Overtemperature cut-out occurs in the range 150 to 190 °C, a typical value being 170 °C. The device is automatically restarted when the chip temperature falls of about 15°C below shut-down temperature.

- **STATUS FEEDBACK:** in the case of an overtemperature fault condition ( $T_j > T_{jsh}$ ), the device tries to sink a diagnostic current  $I_{gf}$  through the INPUT pin in order to indicate fault condition. If driven from a low impedance source, this current may be used in order to warn the control circuit of a device shutdown. If the drive impedance is high enough so that the INPUT pin driver is not able to supply the current  $I_{gf}$ , the INPUT pin will fall to 0V. **This will not however affect the device operation: no requirement is put on the current capability of the INPUT pin driver except to be able to supply the normal operation drive current  $I_{SS}$ .**

Additional features of this device are ESD protection according to the Human Body model and the ability to be driven from a TTL Logic circuit.

Figure 1: Switching Time Test Circuit for Resistive Load

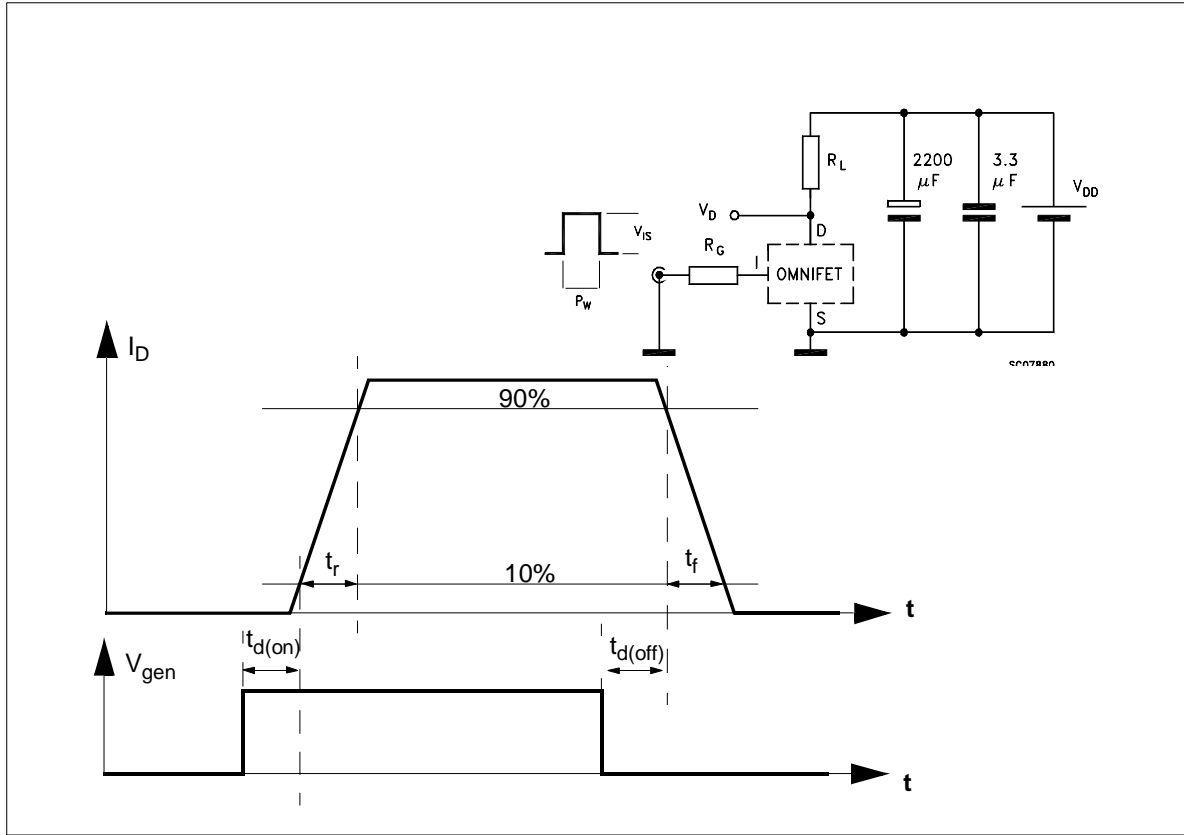
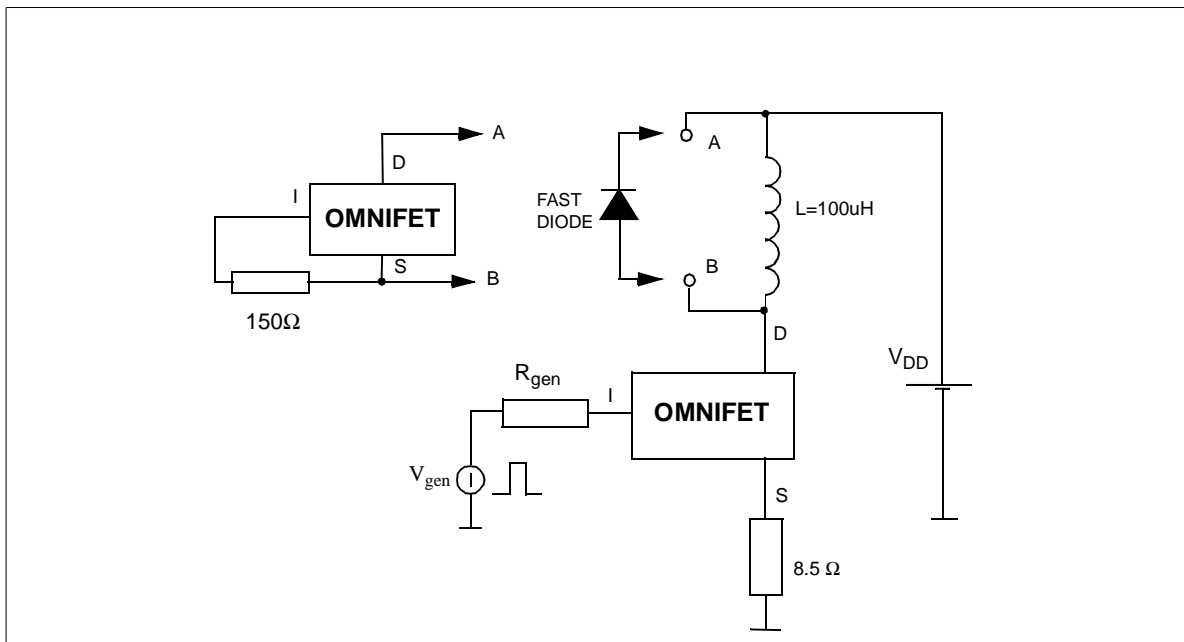
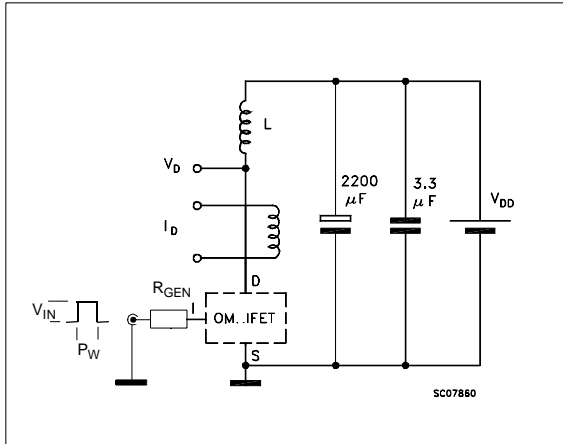

Figure 2: Test Circuit for Diode Recovery Times



**Figure 3:** Unclamped Inductive Load Test Circuits



**Figure 4:** Unclamped Inductive Waveforms

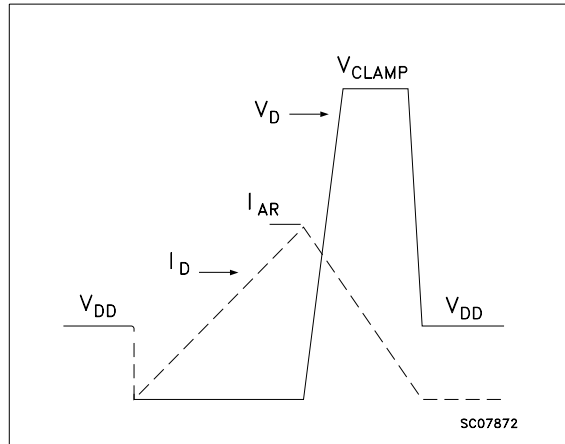

**Figure 5:** Input Charge Test Circuit

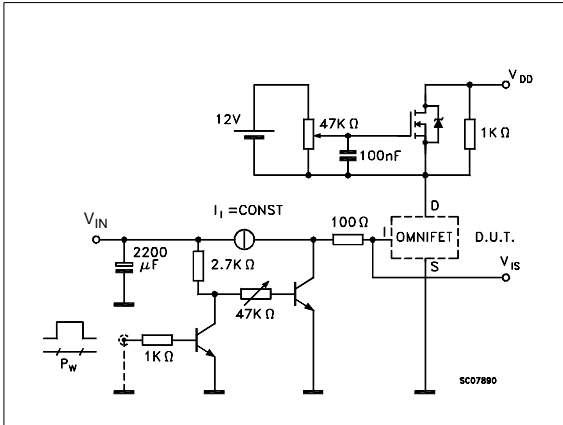

Source-Drain Diode Forward Characteristics

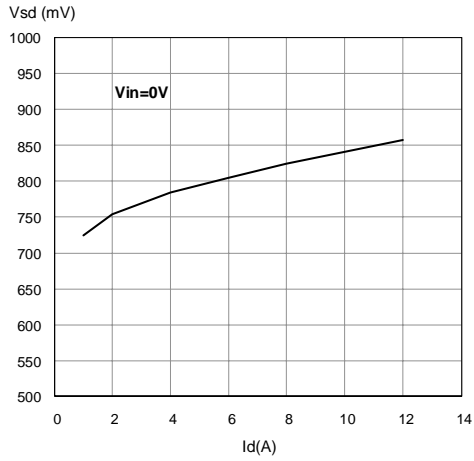

Static Drain Source On Resistance

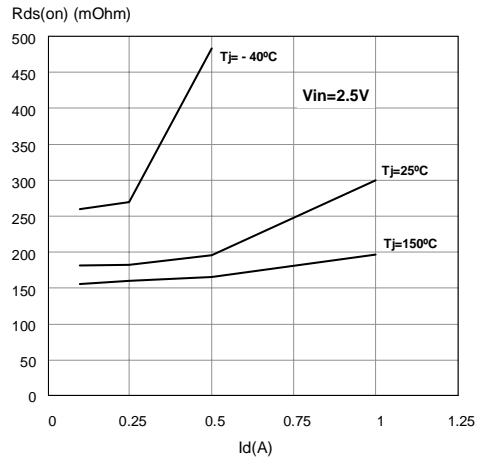

Derating Curve

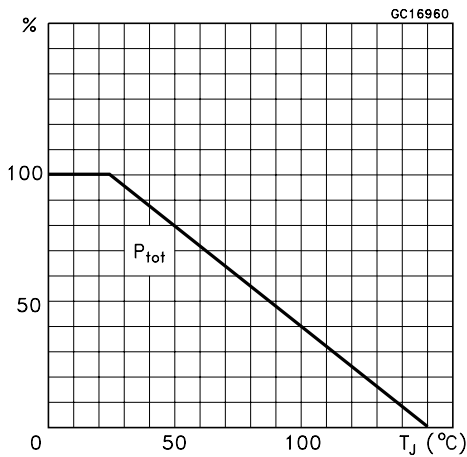

Static Drain-Source On resistance Vs. Input Voltage

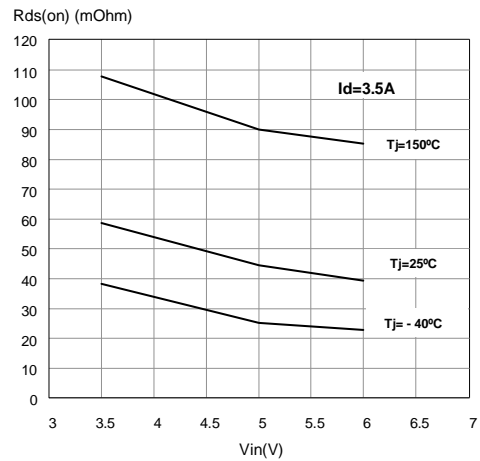

Static Drain-Source On resistance Vs. Input Voltage

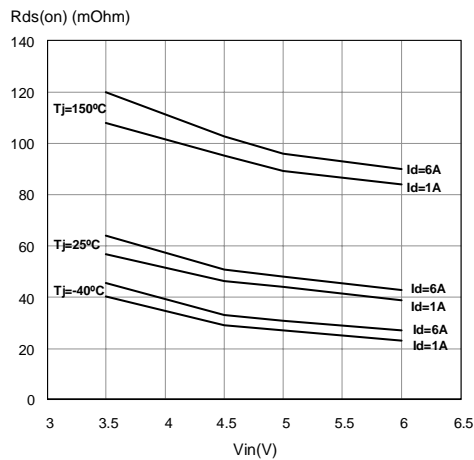

Transconductance

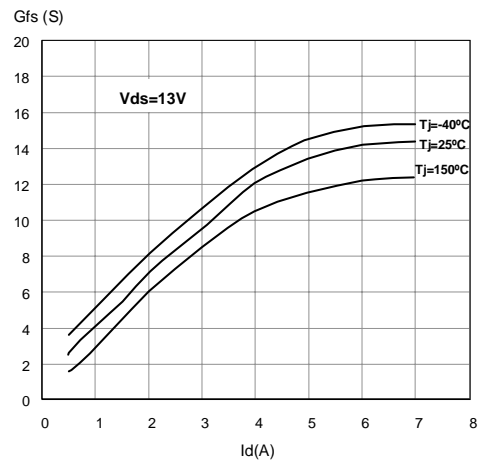



Static Drain-Source On Resistance Vs. Id

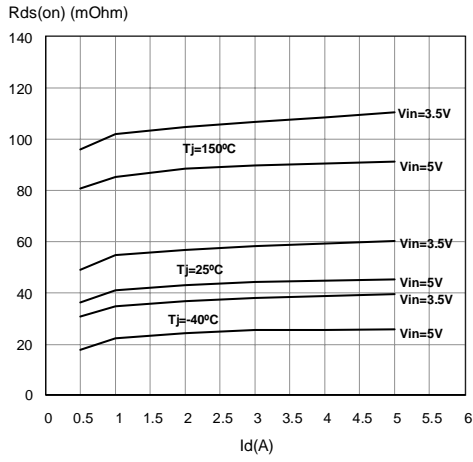

Transfer Characteristics

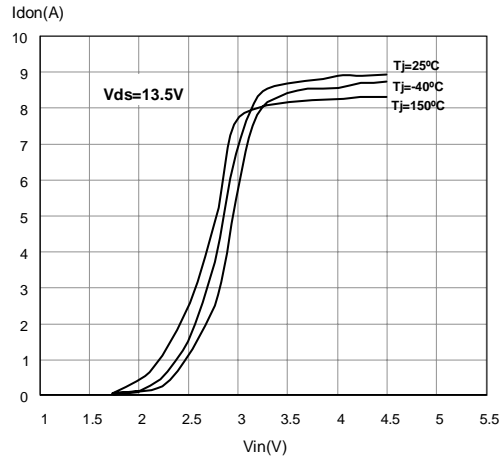

Turn On Current Slope

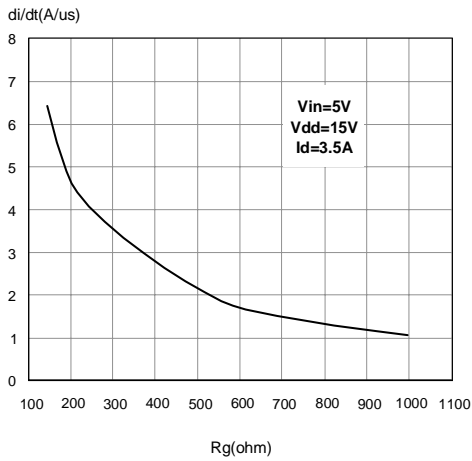

Turn On Current Slope

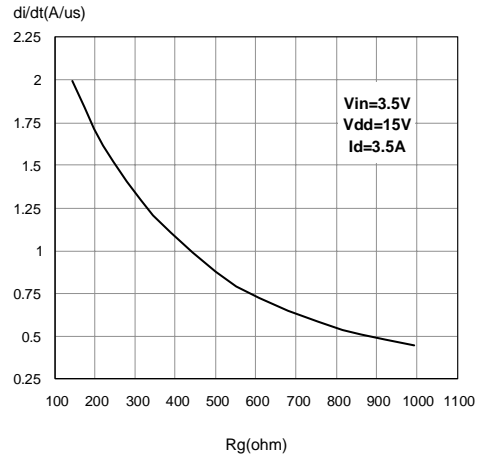

Input Voltage Vs. Input Charge

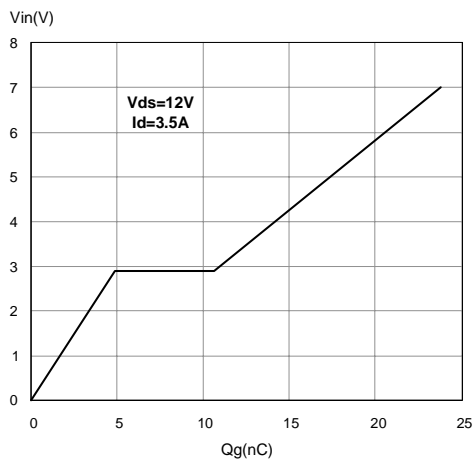

Turn off drain source voltage slope

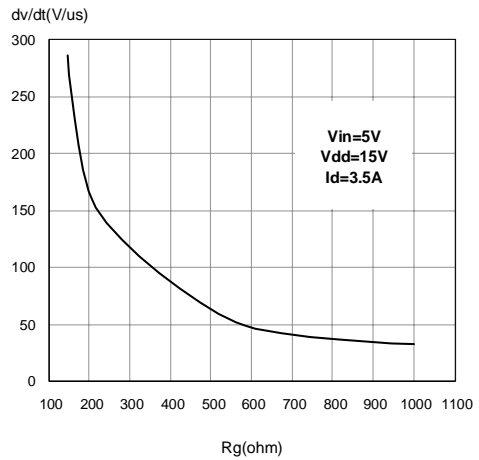

Turn Off Drain-Source Voltage Slope

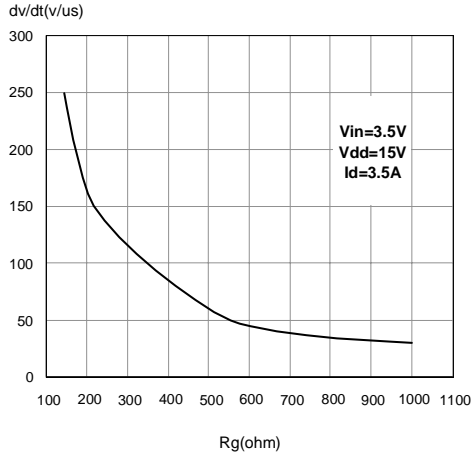

Capacitance Variations

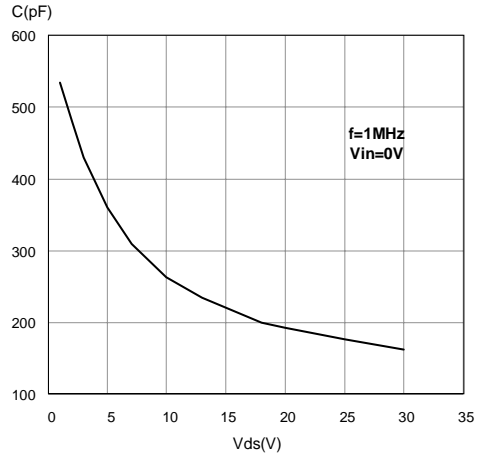

Switching Time Resistive Load

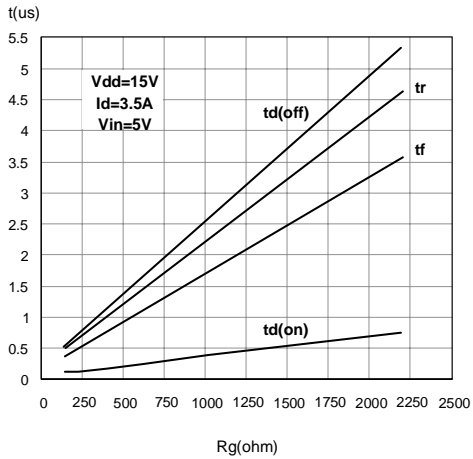

Switching Time Resistive Load

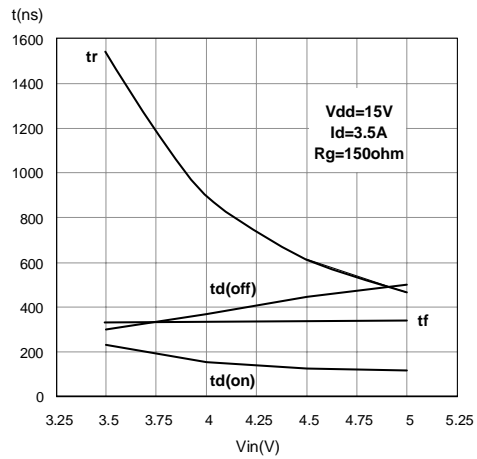

Output Characteristics

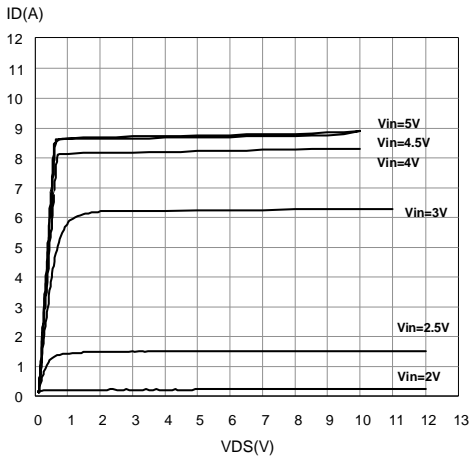

Normalized On Resistance Vs. Temperature

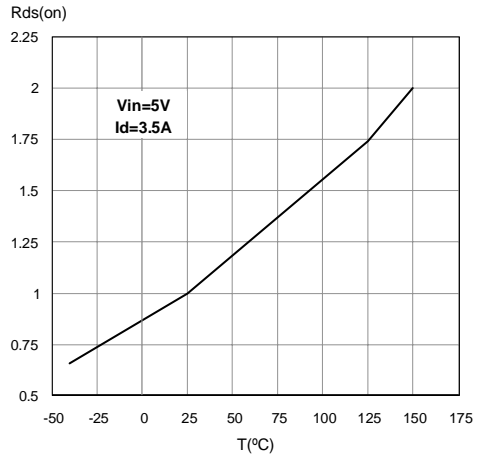

Normalized Input Threshold Voltage Vs. Temperature Current Limit Vs. Junction Temperature

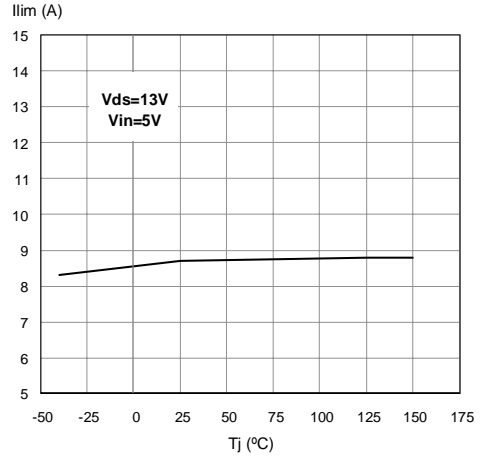
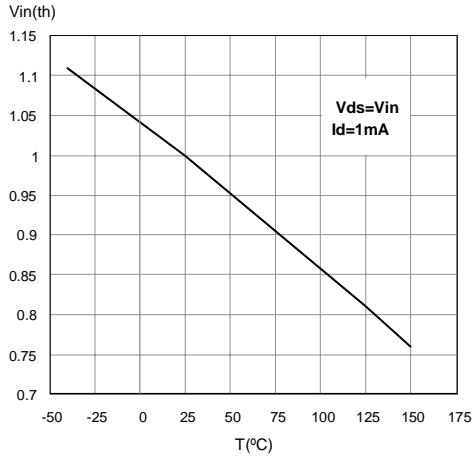

Step Response Current Limit

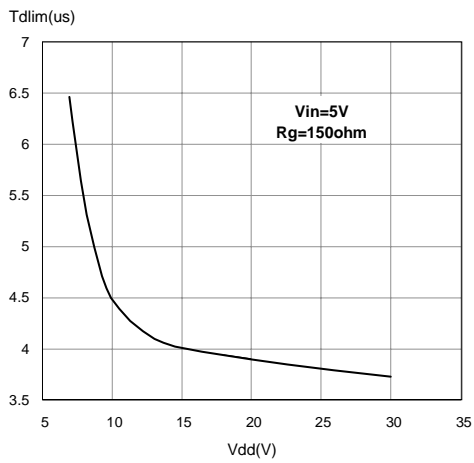

SO-8 Maximum turn off current versus load inductance

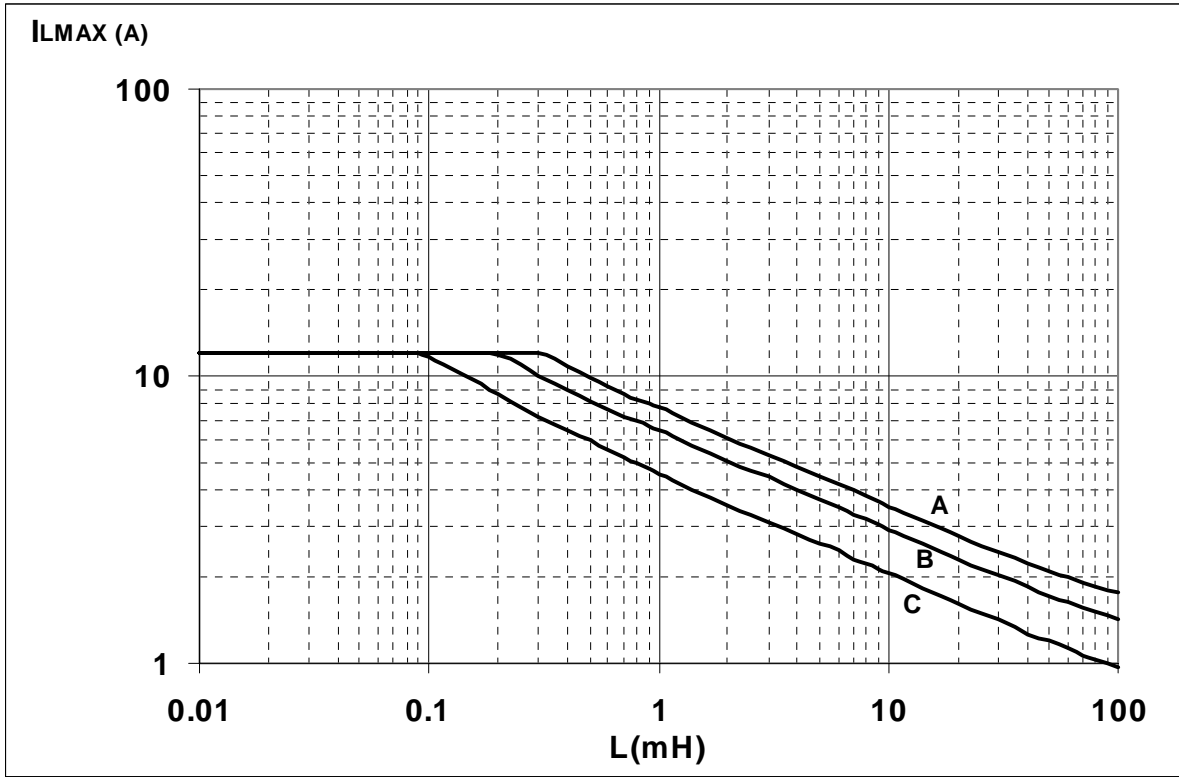

- A = Single Pulse at  $T_{Jstart}=150^{\circ}C$
- B= Repetitive pulse at  $T_{Jstart}=100^{\circ}C$
- C= Repetitive Pulse at  $T_{Jstart}=125^{\circ}C$

Conditions:

$V_{CC}=13.5V$

Values are generated with  $R_L=0\Omega$

In case of repetitive pulses,  $T_{Jstart}$  (at beginning of each demagnetization) of every pulse must not exceed the temperature specified above for curves B and C.

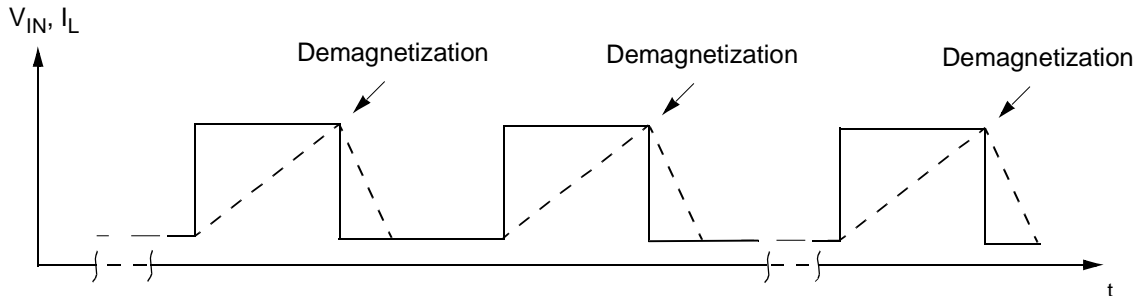

DPAK Maximum turn off current versus load inductance

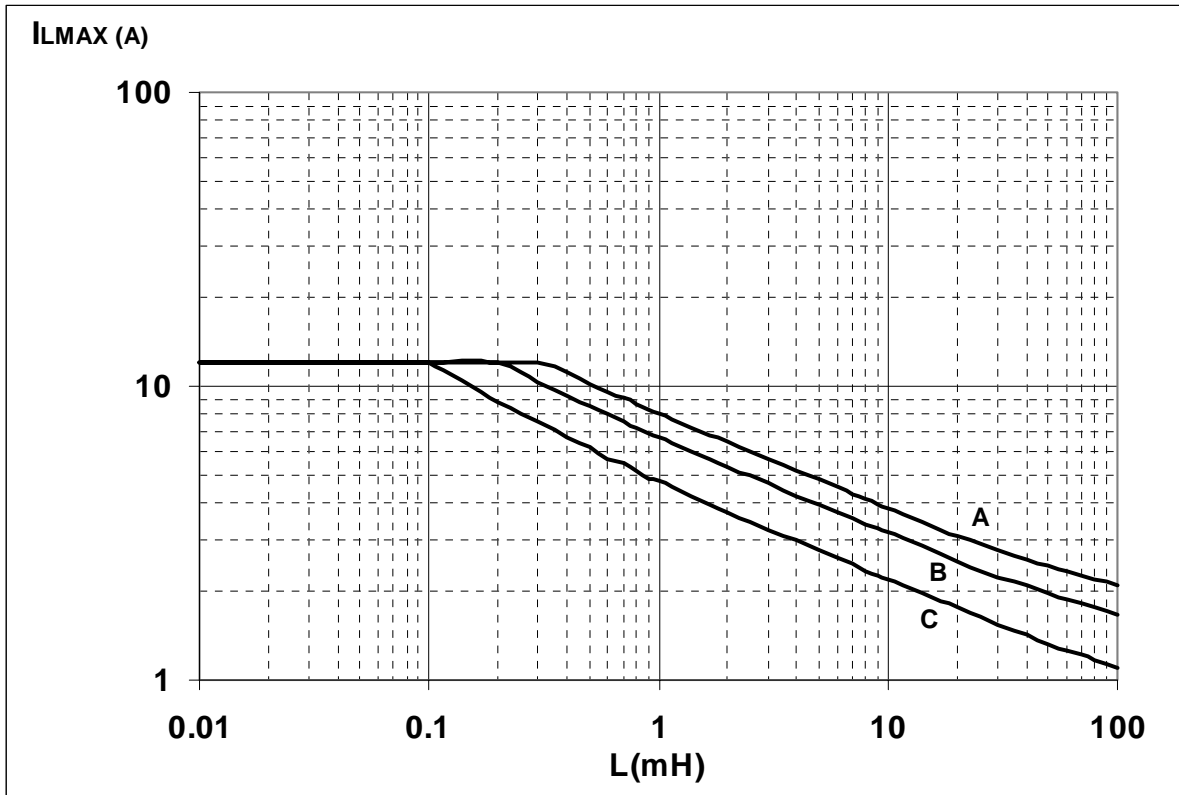

- A = Single Pulse at  $T_{Jstart}=150^{\circ}C$
- B= Repetitive pulse at  $T_{Jstart}=100^{\circ}C$
- C= Repetitive Pulse at  $T_{Jstart}=125^{\circ}C$

Conditions:

$V_{CC}=13.5V$

Values are generated with  $R_L=0\Omega$

In case of repetitive pulses,  $T_{Jstart}$  (at beginning of each demagnetization) of every pulse must not exceed the temperature specified above for curves B and C.

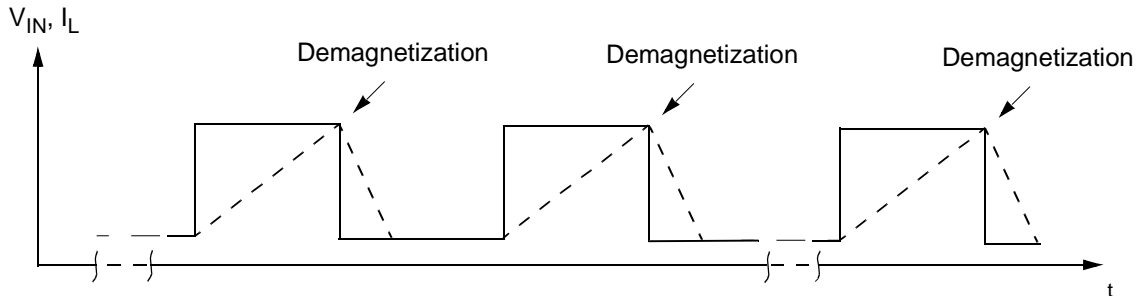

SOT-223 Maximum turn off current versus load inductance

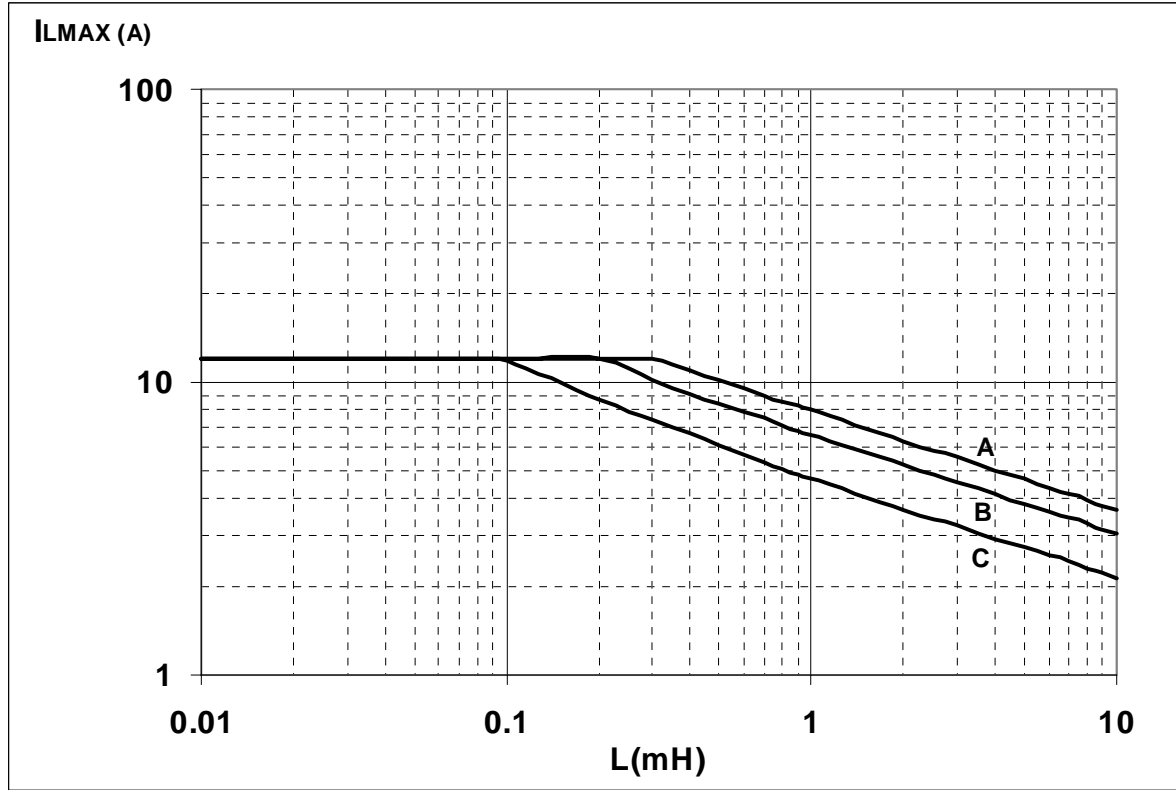

- A = Single Pulse at  $T_{Jstart}=150^{\circ}C$
- B= Repetitive pulse at  $T_{Jstart}=100^{\circ}C$
- C= Repetitive Pulse at  $T_{Jstart}=125^{\circ}C$

Conditions:

$V_{CC}=13.5V$

Values are generated with  $R_L=0\Omega$

In case of repetitive pulses,  $T_{Jstart}$  (at beginning of each demagnetization) of every pulse must not exceed the temperature specified above for curves B and C.

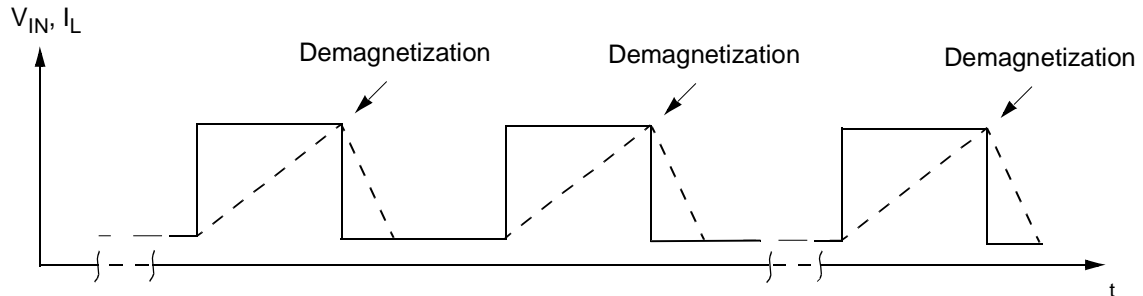

**SO-8 THERMAL DATA**

**SO-8 PC Board**

UNSxNU04      0.14cm<sup>2</sup>



UNSxNU04      0.6cm<sup>2</sup>



UNSxNU04      1.6cm<sup>2</sup>

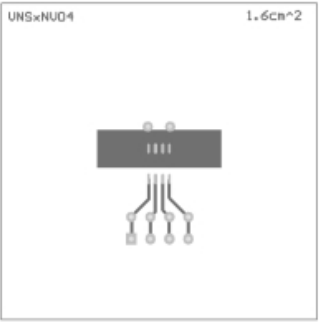

Layout condition of  $R_{th}$  and  $Z_{th}$  measurements (PCB FR4 area= 58mm x 58mm, PCB thickness=2mm, Cu thickness=35 $\mu$ m, Copper areas: 0.14cm<sup>2</sup>, 0.6cm<sup>2</sup>, 1.6cm<sup>2</sup>).

**$R_{thj-amb}$  Vs PCB copper area in open box free air condition**

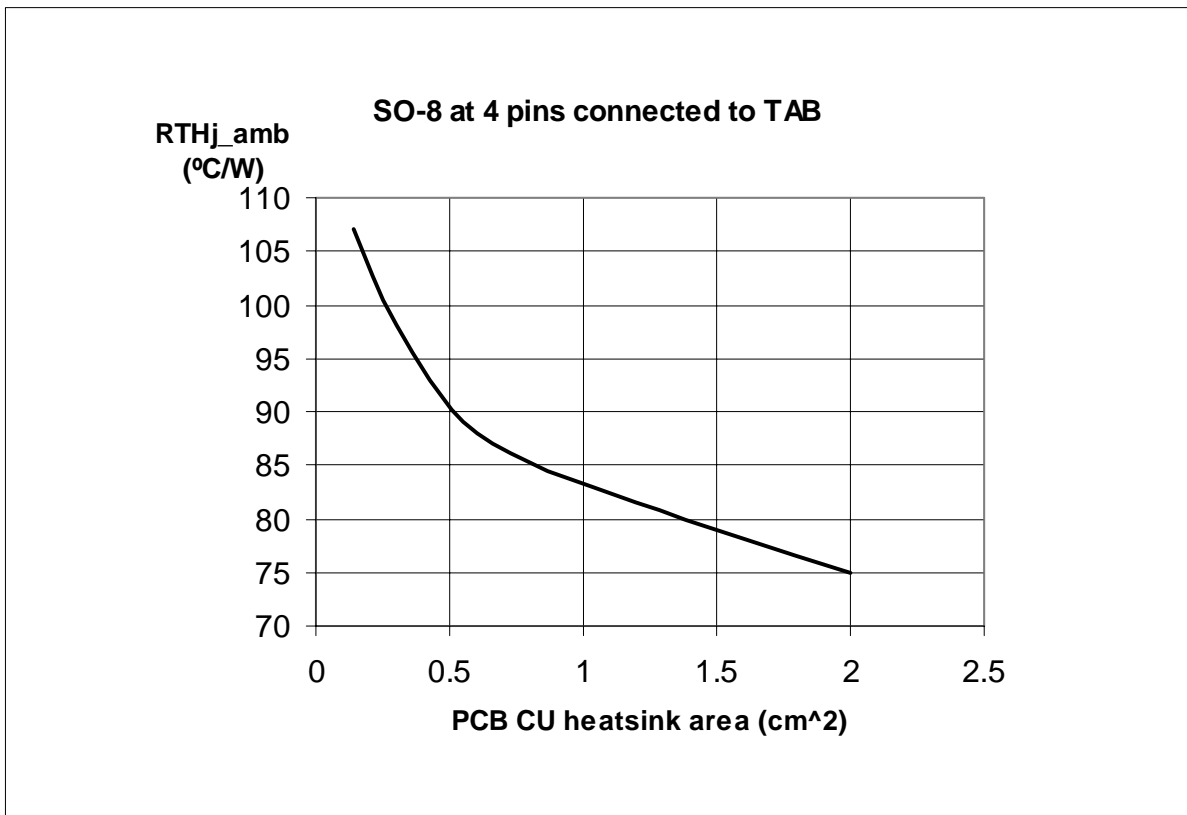

**SOT-223 THERMAL DATA**

**SOT-223 PC Board**

SOT223      0.11cm<sup>2</sup>



SOT223      1cm<sup>2</sup>

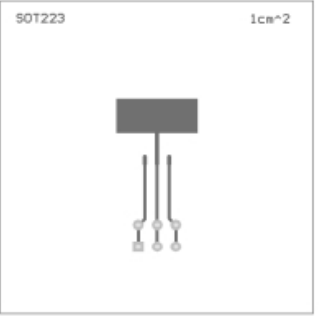

SOT223      2cm<sup>2</sup>

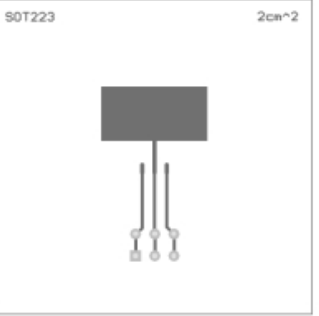

Layout condition of  $R_{th}$  and  $Z_{th}$  measurements (PCB FR4 area= 58mm x 58mm, PCB thickness=2mm, Cu thickness=35μm, Copper areas: 0.11cm<sup>2</sup>, 1cm<sup>2</sup>, 2cm<sup>2</sup>).

**$R_{thj-amb}$  Vs PCB copper area in open box free air condition**

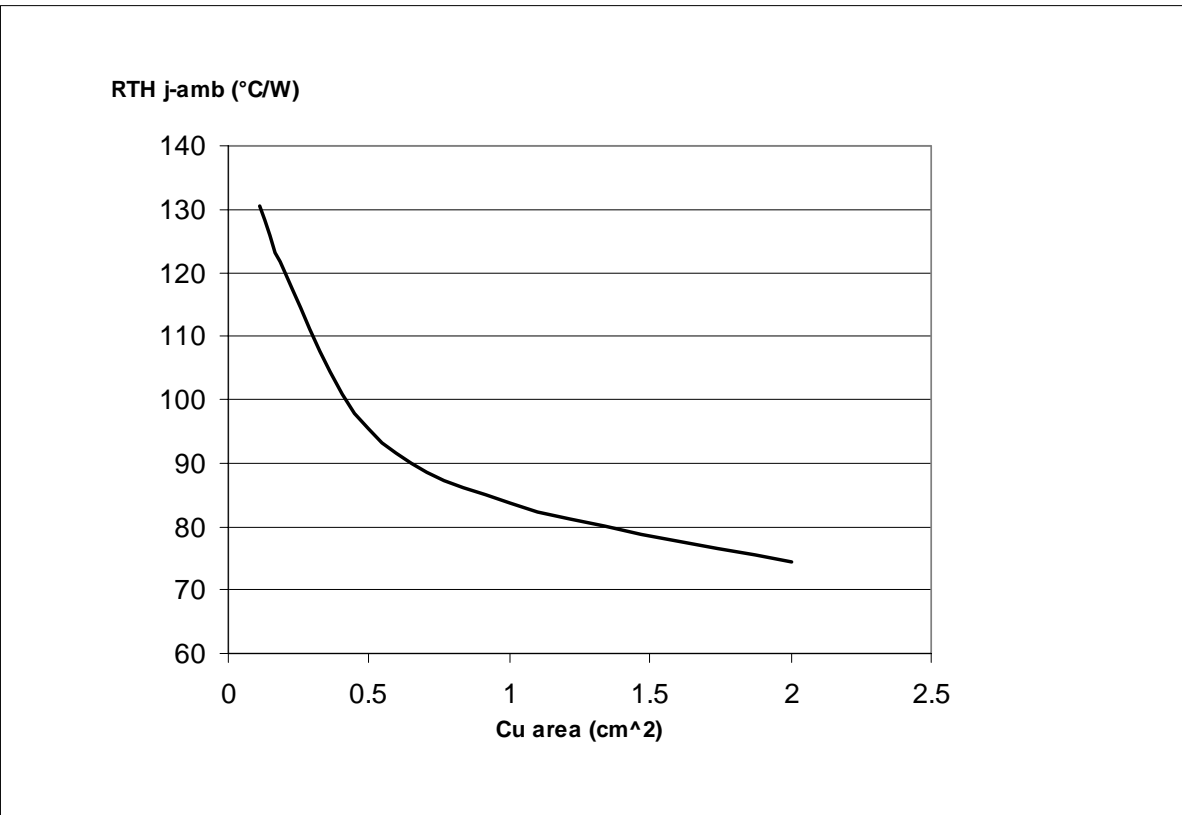



**DPAK THERMAL DATA**

**DPAK PC Board**

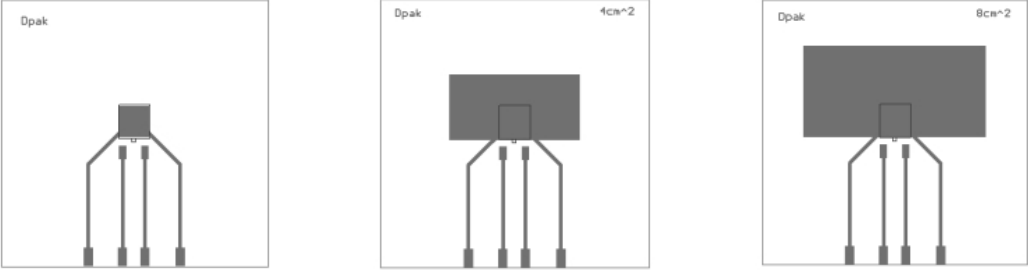

Layout condition of  $R_{th}$  and  $Z_{th}$  measurements (PCB FR4 area= 60mm x 60mm, PCB thickness=2mm, Cu thickness=35 $\mu$ m, Copper areas: from minimum pad lay-out to 8cm<sup>2</sup>).

**$R_{thj-amb}$  Vs PCB copper area in open box free air condition**

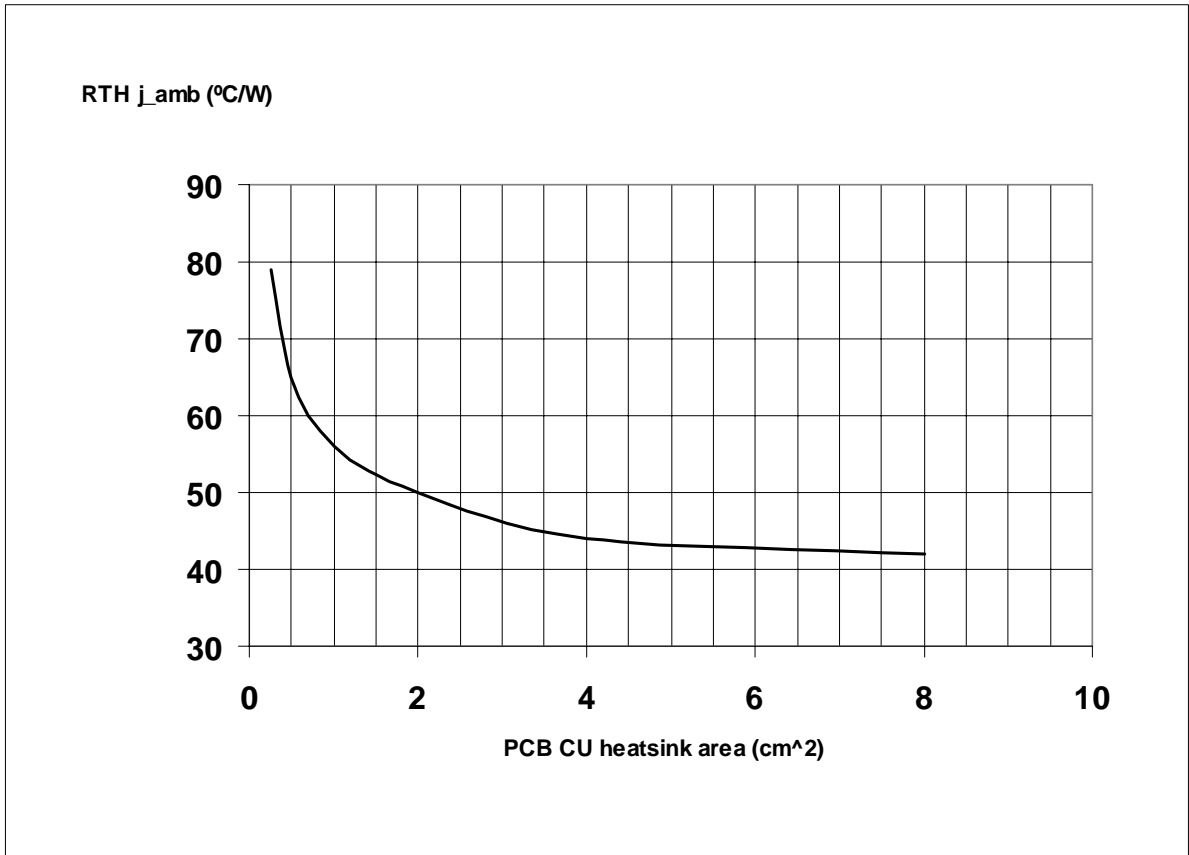

DPAK Thermal Impedance Junction Ambient Single Pulse

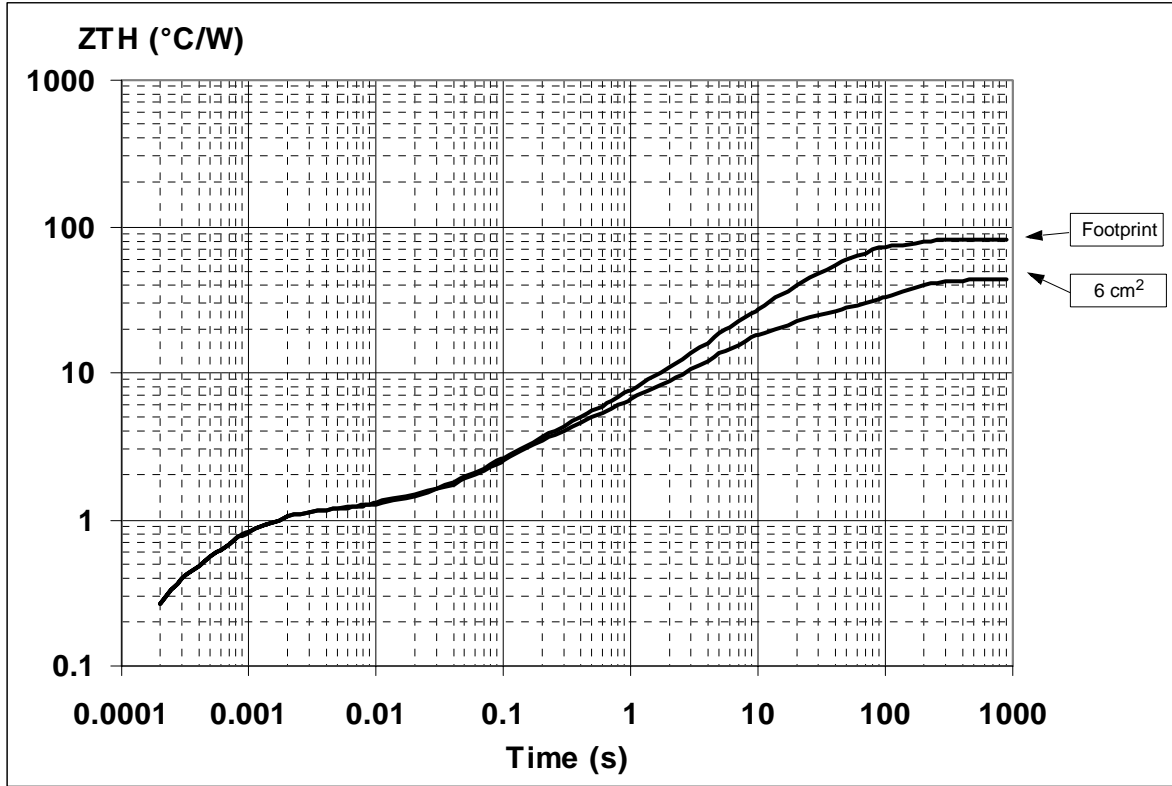

Thermal fitting model of an OMNIFET II in DPAK

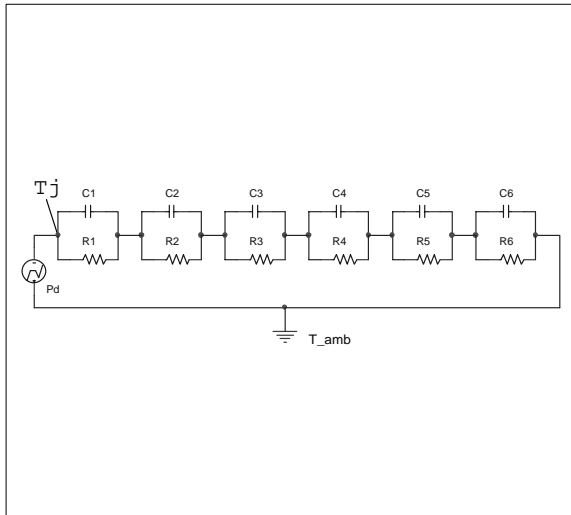

Pulse calculation formula

$$Z_{TH\delta} = R_{TH} \cdot \delta + Z_{THtp}(1 - \delta)$$

where  $\delta = t_p/T$

Thermal Parameter

Area/island (cm <sup>2</sup> )	Footprint	6
R1 (°C/W)	0.1	
R2 (°C/W)	0.35	
R3 (°C/W)	1.20	
R4 (°C/W)	2	
R5 (°C/W)	15	
R6 (°C/W)	61	24
C1 (W.s/°C)	0.0006	
C2 (W.s/°C)	0.0021	
C3 (W.s/°C)	0.05	
C4 (W.s/°C)	0.3	
C5 (W.s/°C)	0.45	
C6 (W.s/°C)	0.8	5

SO-8 Thermal Impedance Junction Ambient Single Pulse

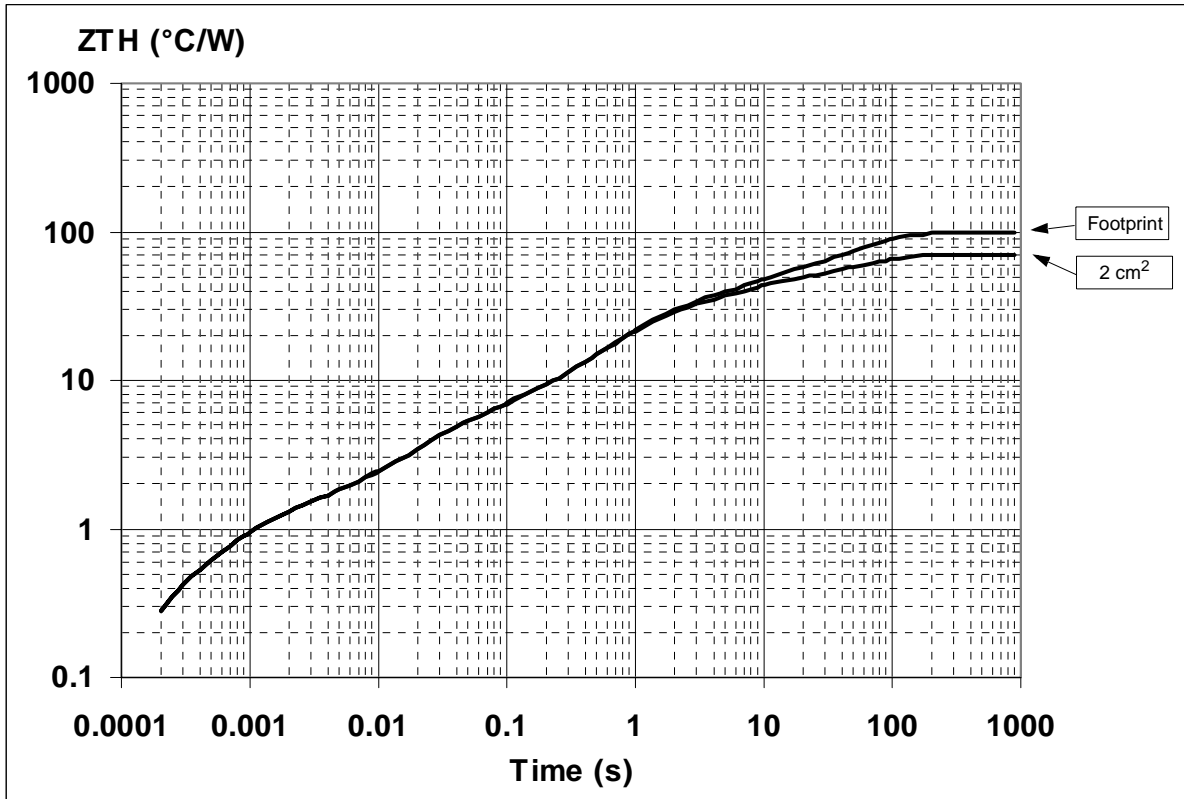

Thermal fitting model of an OMNIFET II in SO-8

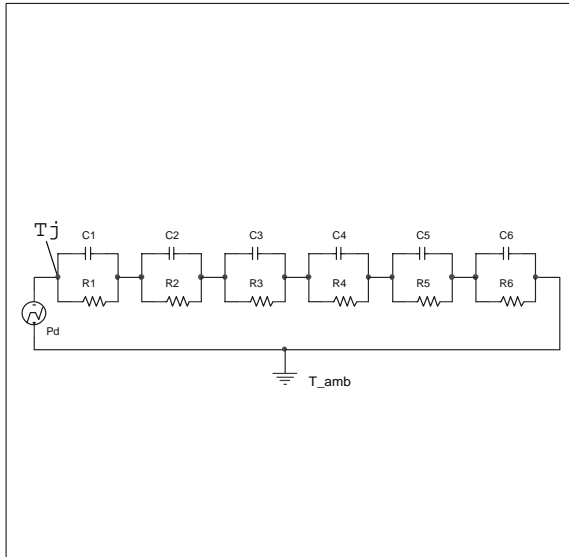

Pulse calculation formula

$$Z_{TH\delta} = R_{TH} \cdot \delta + Z_{THtp}(1 - \delta)$$

where  $\delta = t_p/T$

Thermal Parameter

Area/island (cm <sup>2</sup> )	Footprint	2
R1 (°C/W)	0.2	
R2 (°C/W)	0.9	
R3 (°C/W)	3.5	
R4 (°C/W)	21	
R5 (°C/W)	16	
R6 (°C/W)	58	28
C1 (W.s/°C)	3.00E-04	
C2 (W.s/°C)	9.00E-04	
C3 (W.s/°C)	7.50E-03	
C4 (W.s/°C)	0.045	
C5 (W.s/°C)	0.35	
C6 (W.s/°C)	1.05	2

SOT-223 Thermal Impedance Junction Ambient Single Pulse

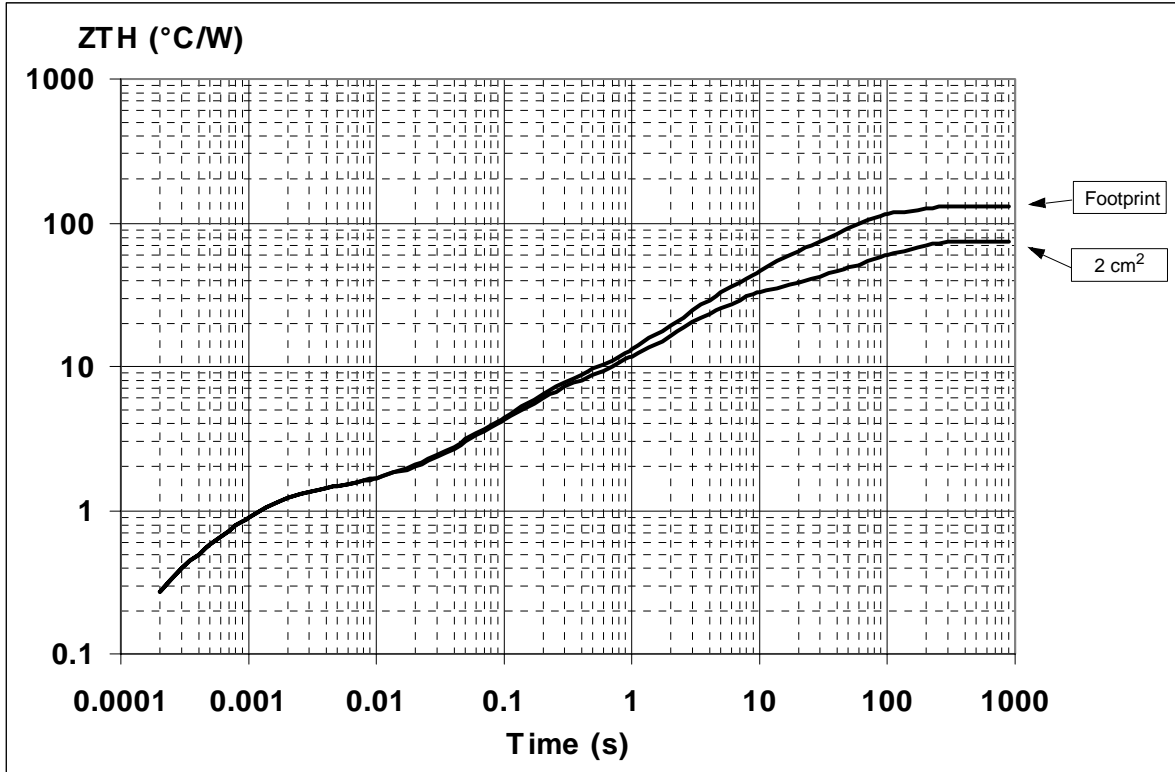

Thermal fitting model of an OMNIFET II in SOT-223

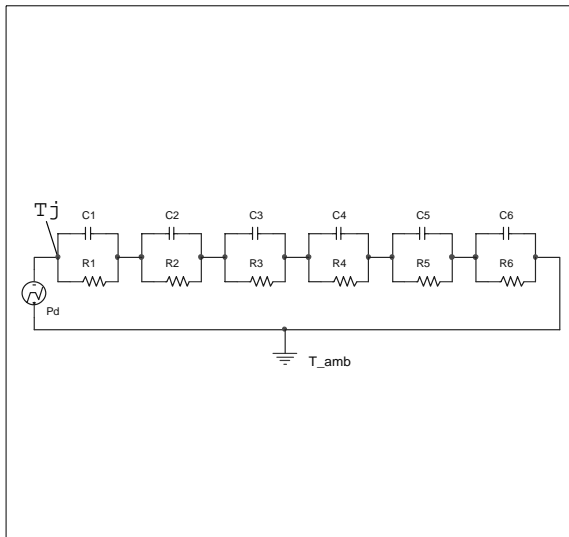

Pulse calculation formula

$$Z_{TH\delta} = R_{TH} \cdot \delta + Z_{THtp}(1 - \delta)$$

where  $\delta = t_p/T$

Thermal Parameter

Area/island (cm <sup>2</sup> )	Footprint	2
R1 (°C/W)	0.2	
R2 (°C/W)	1.1	
R3 (°C/W)	4.5	
R4 (°C/W)	24	
R5 (°C/W)	0.1	
R6 (°C/W)	100	45
C1 (W.s/°C)	3.00E-04	
C2 (W.s/°C)	9.00E-04	
C3 (W.s/°C)	3.00E-02	
C4 (W.s/°C)	0.16	
C5 (W.s/°C)	1000	
C6 (W.s/°C)	0.5	2

**TO-251 (IPAK) MECHANICAL DATA**

DIM.	mm.			inch		
	MIN.	TYP	MAX.	MIN.	TYP.	MAX.
A	2.2		2.4	0.086		0.094
A1	0.9		1.1	0.035		0.043
A3	0.7		1.3	0.027		0.051
B	0.64		0.9	0.025		0.031
B2	5.2		5.4	0.204		0.212
B3			0.85			0.033
B5		0.3			0.012	
B6			0.95			0.037
C	0.45		0.6	0.017		0.023
C2	0.48		0.6	0.019		0.023
D	6		6.2	0.236		0.244
E	6.4		6.6	0.252		0.260
G	4.4		4.6	0.173		0.181
H	15.9		16.3	0.626		0.641
L	9		9.4	0.354		0.370
L1	0.8		1.2	0.031		0.047
L2		0.8	1		0.031	0.039

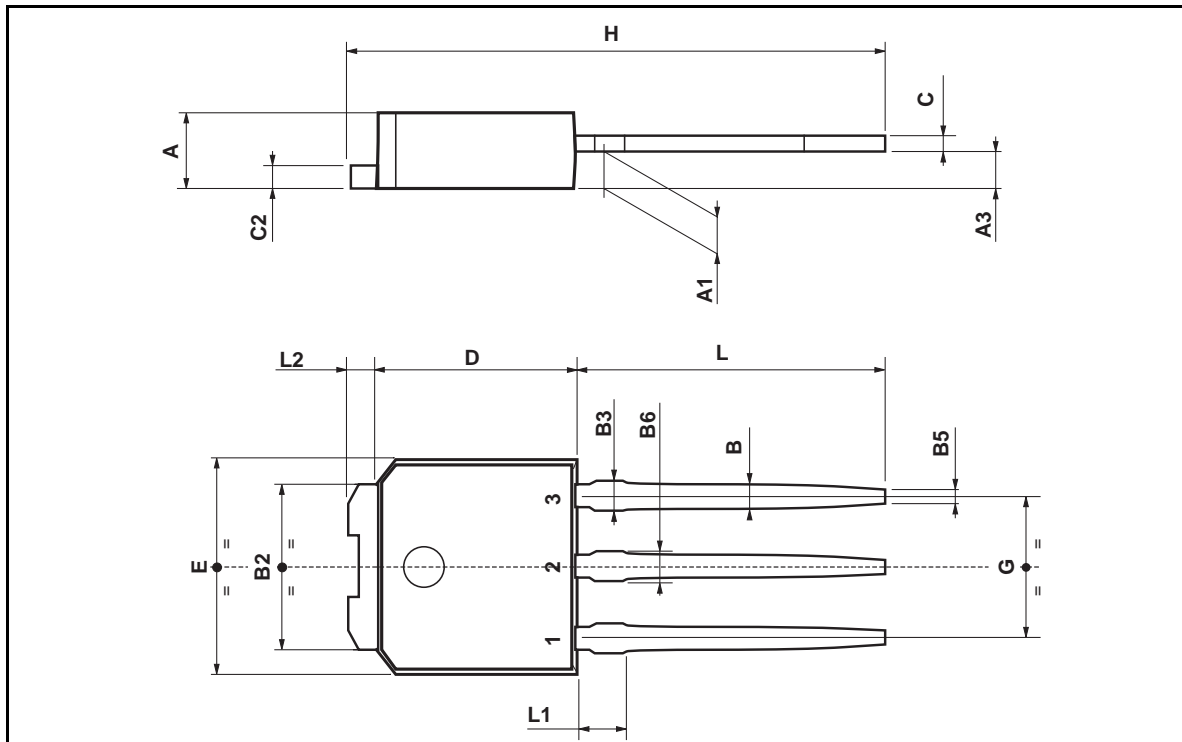

**TO-252 (DPAK) MECHANICAL DATA**

DIM.	mm.			inch		
	MIN.	TYP	MAX.	MIN.	TYP.	MAX.
A	2.2		2.4	0.086		0.094
A1	0.9		1.1	0.035		0.043
A2	0.03		0.23	0.001		0.009
B	0.64		0.9	0.025		0.035
B2	5.2		5.4	0.204		0.212
C	0.45		0.6	0.017		0.023
C2	0.48		0.6	0.019		0.023
D	6		6.2	0.236		0.244
E	6.4		6.6	0.252		0.260
G	4.4		4.6	0.173		0.181
H	9.35		10.1	0.368		0.397
L2		0.8			0.031	
L4	0.6		1	0.023		0.039
R		0.2			0.008	
V2	0°	8°		0°	8°	

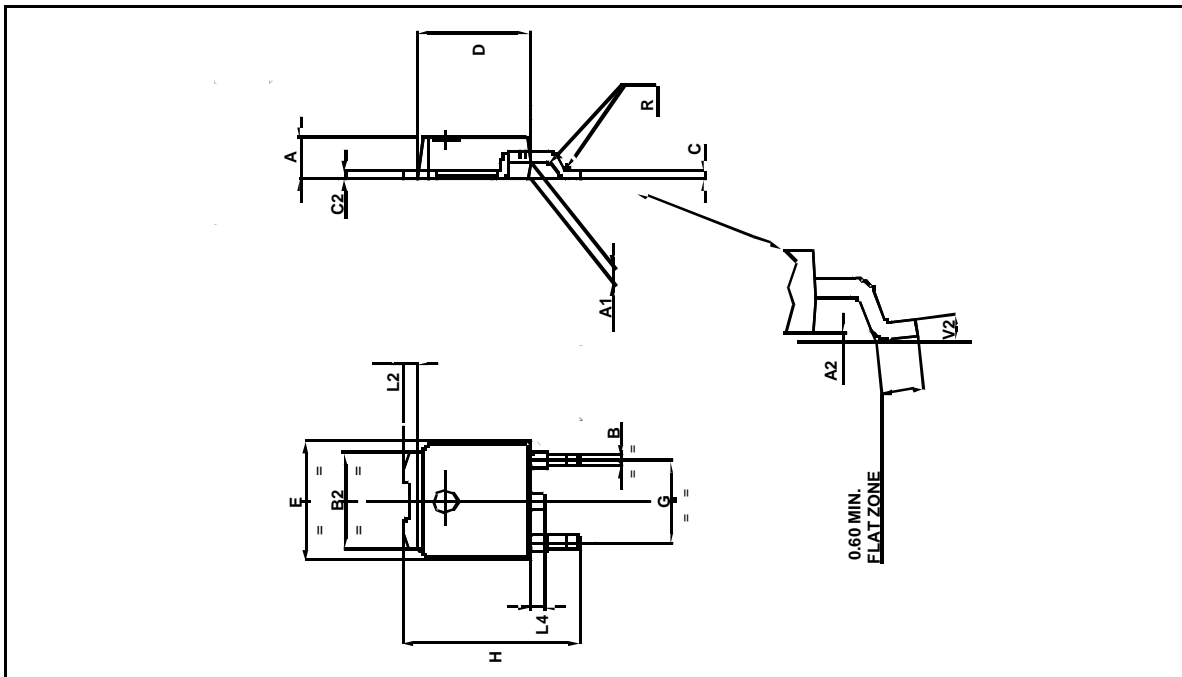

**SOT-223 MECHANICAL DATA**

DIM.	mm.			inch		
	MIN.	TYP	MAX.	MIN.	TYP.	MAX.
A			1.8			0.071
B	0.6	0.7	0.85	0.024	0.027	0.033
B1	2.9	3	3.15	0.114	0.118	0.124
c	0.24	0.26	0.35	0.009	0.01	0.014
D	6.3	6.5	6.7	0.248	0.256	0.264
e		2.3			0.09	
e1		4.6			0.181	
E	3.3	3.5	3.7	0.13	0.138	0.146
H	6.7	7	7.3	0.264	0.276	0.287
V	10 (max)					
A1	0.02		0.1	0.0008		0.004

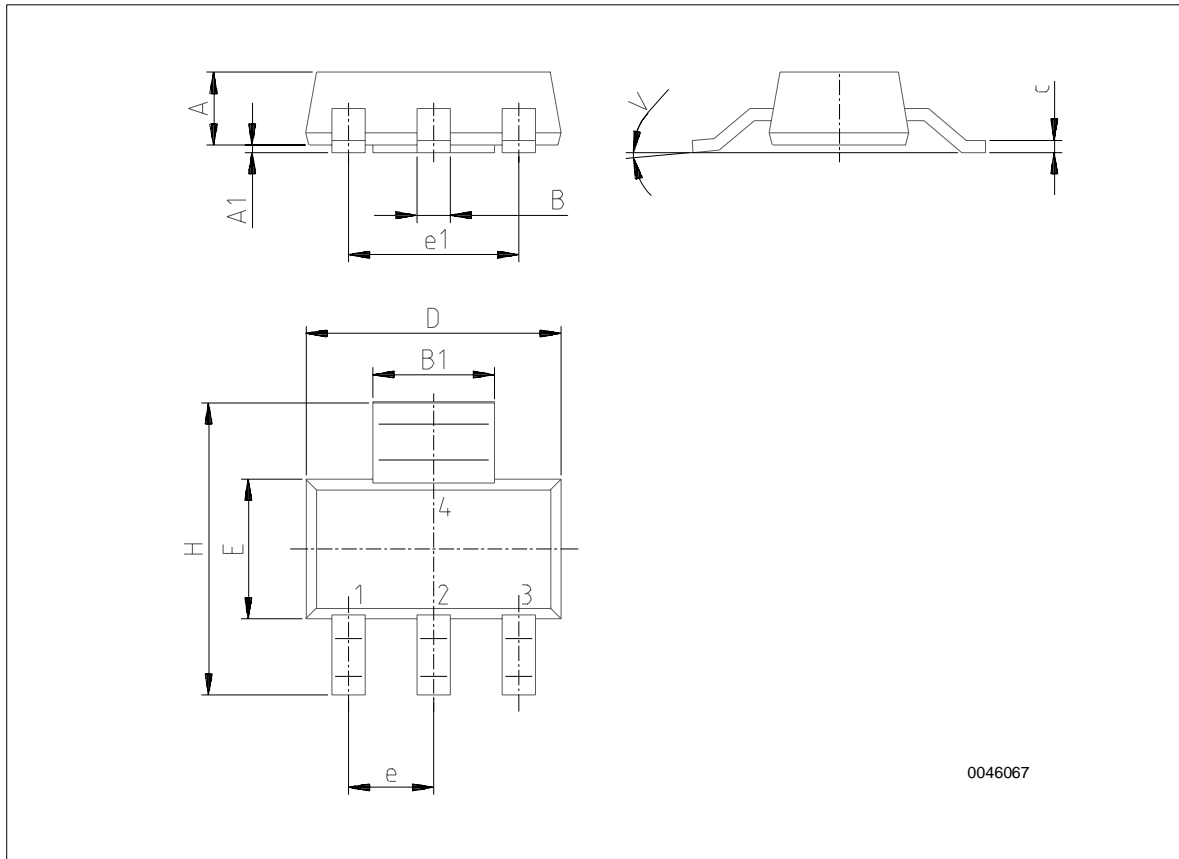

0046067

**SO-8 MECHANICAL DATA**

DIM.	mm.			inch		
	MIN.	TYP.	MAX.	MIN.	TYP.	MAX.
A			1.75			0.068
a1	0.1		0.25	0.003		0.009
a2			1.65			0.064
a3	0.65		0.85	0.025		0.033
b	0.35		0.48	0.013		0.018
b1	0.19		0.25	0.007		0.010
C	0.25		0.5	0.010		0.019
c1	45 (typ.)					
D	4.8		5.0	0.188		0.196
E	5.8		6.2	0.228		0.244
e		1.27			0.050	
e3		3.81			0.150	
F	3.8		4.0	0.14		0.157
L	0.4		1.27	0.015		0.050
M			0.6			0.023
F	8 (max.)					

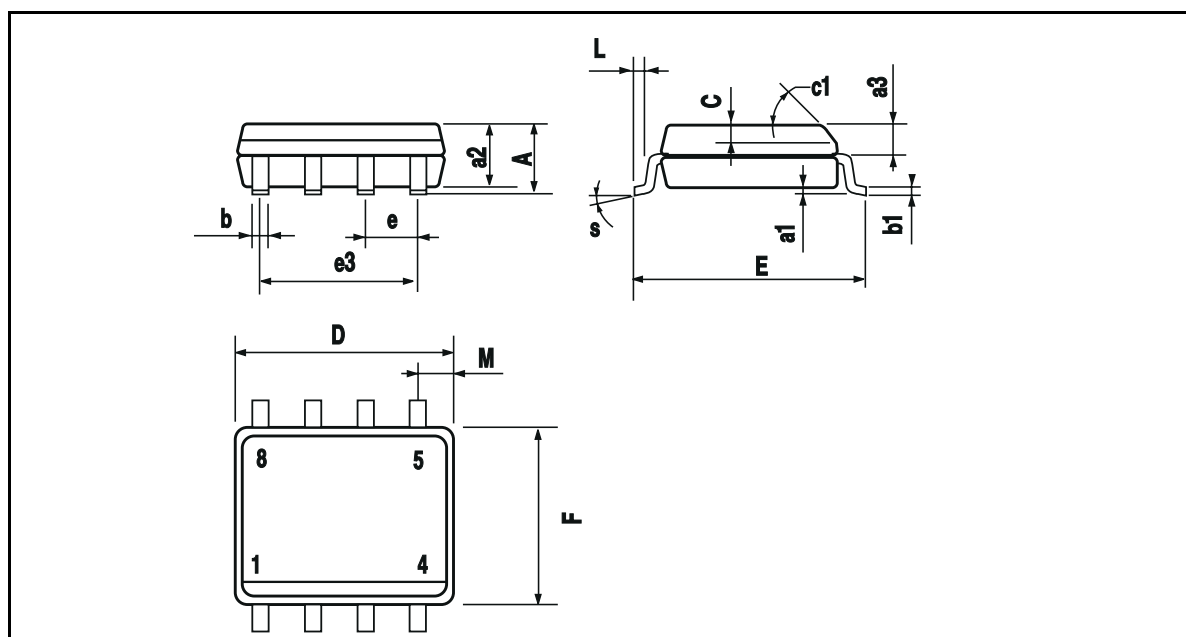



**SOT-223 TAPE AND REEL SHIPMENT (suffix "13TR")**

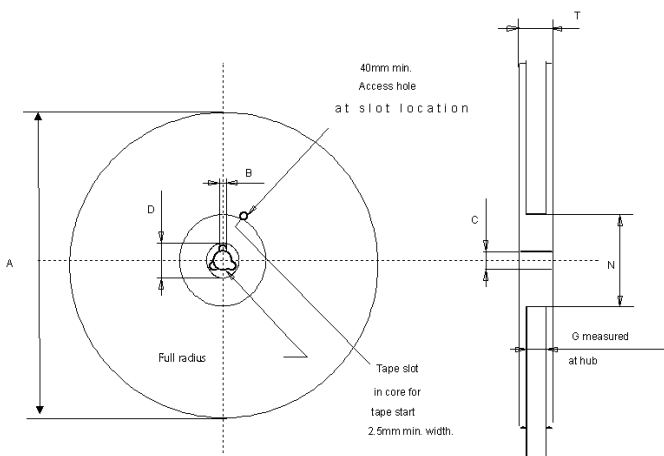

**REEL DIMENSIONS**

Base Q.ty	1000
Bulk Q.ty	1000
A (max)	330
B (min)	1.5
C ( $\pm 0.2$ )	13
F	20.2
G (+ 2 / -0)	12.4
N (min)	60
T (max)	18.4

**TAPE DIMENSIONS**

According to Electronic Industries Association (EIA) Standard 481 rev. A, Feb. 1986

Tape width	W	12
Tape Hole Spacing	P0 ( $\pm 0.1$ )	4
Component Spacing	P	8
Hole Diameter	D ( $\pm 0.1/-0$ )	1.5
Hole Diameter	D1 (min)	1.5
Hole Position	F ( $\pm 0.05$ )	5.5
Compartment Depth	K (max)	4.5
Hole Spacing	P1 ( $\pm 0.1$ )	2

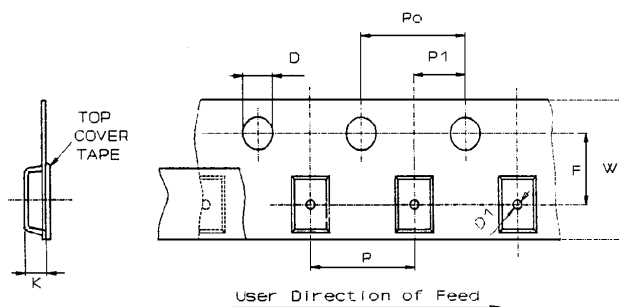

All dimensions are in mm.

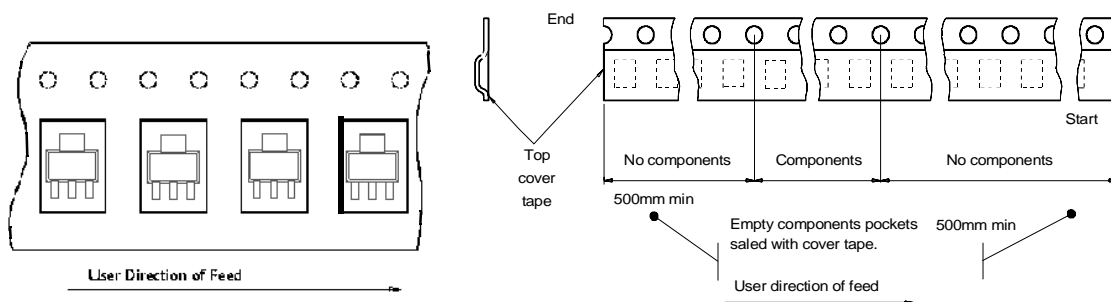

VNN7NV04 / VNS7NV04 / VND7NV04 / VND7NV04-1

SO-8 TUBE SHIPMENT (no suffix)

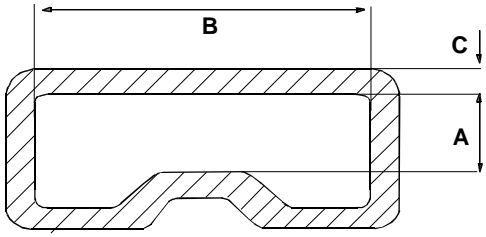

<b>Base Q.ty</b>	100
<b>Bulk Q.ty</b>	2000
<b>Tube length (± 0.5)</b>	532
<b>A</b>	3.2
<b>B</b>	6
<b>C (± 0.1)</b>	0.6

All dimensions are in mm.

TAPE AND REEL SHIPMENT (suffix "13TR")

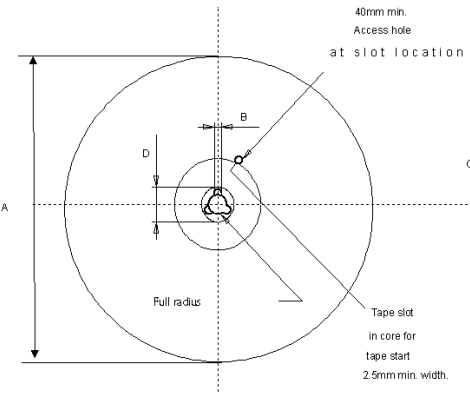
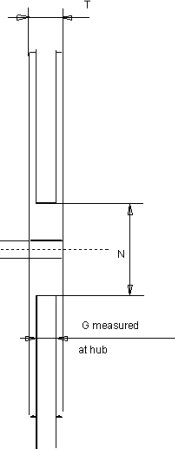
<b>Base Q.ty</b>	2500
<b>Bulk Q.ty</b>	2500
<b>A (max)</b>	330
<b>B (min)</b>	1.5
<b>C (± 0.2)</b>	13
<b>F</b>	20.2
<b>G (+ 2 / -0)</b>	12.4
<b>N (min)</b>	60
<b>T (max)</b>	18.4

All dimensions are in mm.

**TAPE DIMENSIONS**

According to Electronic Industries Association (EIA) Standard 481 rev. A, Feb 1986

<b>Tape width</b>	<b>W</b>	12
<b>Tape Hole Spacing</b>	<b>P0 (± 0.1)</b>	4
<b>Component Spacing</b>	<b>P</b>	8
<b>Hole Diameter</b>	<b>D (± 0.1/-0)</b>	1.5
<b>Hole Diameter</b>	<b>D1 (min)</b>	1.5
<b>Hole Position</b>	<b>F (± 0.05)</b>	5.5
<b>Compartment Depth</b>	<b>K (max)</b>	4.5
<b>Hole Spacing</b>	<b>P1 (± 0.1)</b>	2

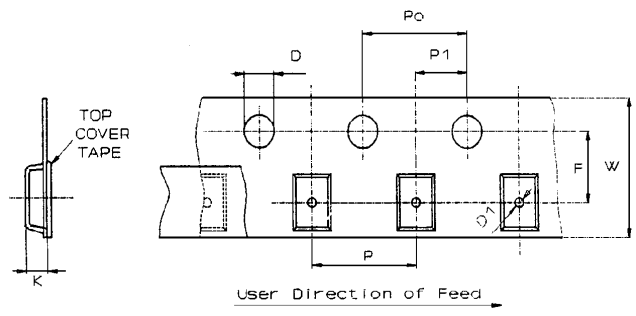

All dimensions are in mm.

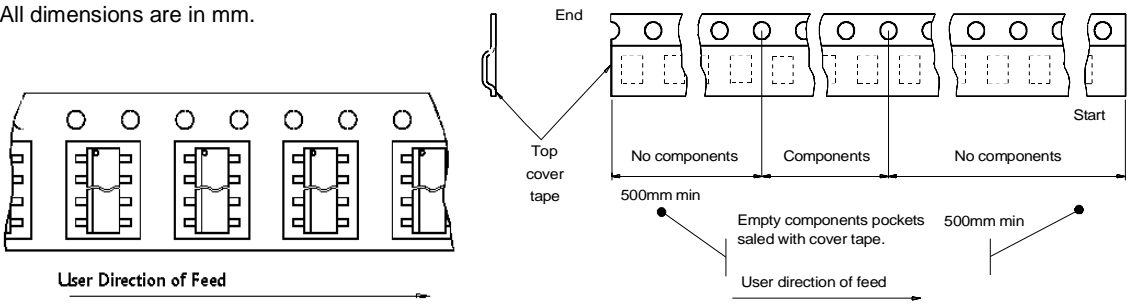

**DPAK FOOTPRINT**

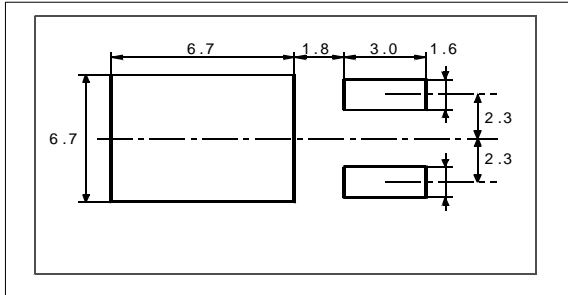

**TUBE SHIPMENT (no suffix)**

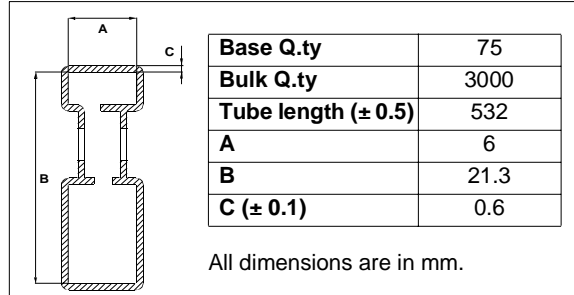

**TAPE AND REEL SHIPMENT (suffix "13TR")**

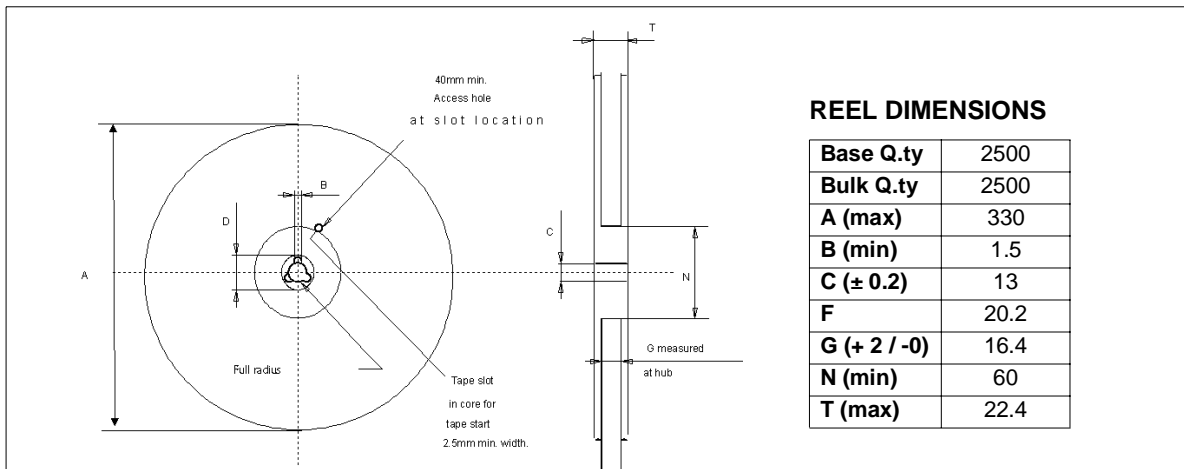

**TAPE DIMENSIONS**

According to Electronic Industries Association (EIA) Standard 481 rev. A, Feb 1986

Tape width	W	16
Tape Hole Spacing	P0 ( $\pm 0.1$ )	4
Component Spacing	P	8
Hole Diameter	D ( $\pm 0.1/-0$ )	1.5
Hole Diameter	D1 (min)	1.5
Hole Position	F ( $\pm 0.05$ )	7.5
Compartment Depth	K (max)	6.5
Hole Spacing	P1 ( $\pm 0.1$ )	2

All dimensions are in mm.

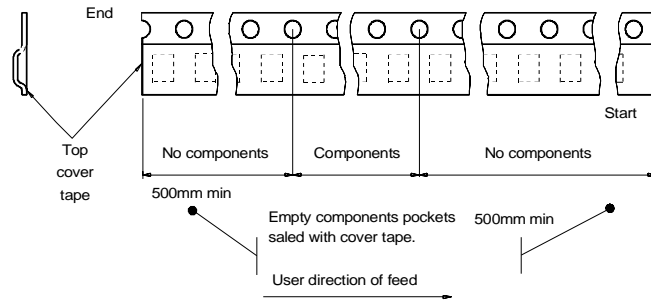
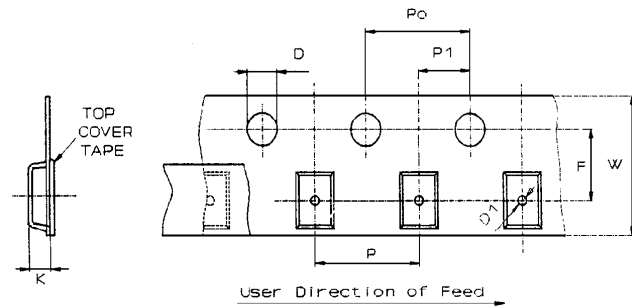
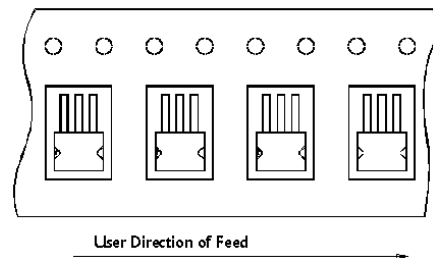

**IPAK TUBE SHIPMENT (no suffix)**

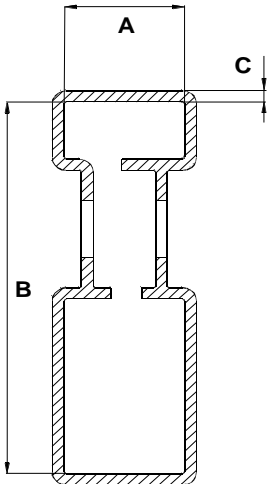

<b>Base Q.ty</b>	75
<b>Bulk Q.ty</b>	3000
<b>Tube length (<math>\pm 0.5</math>)</b>	532
<b>A</b>	6
<b>B</b>	21.3
<b>C (<math>\pm 0.1</math>)</b>	0.6

All dimensions are in mm.

Information furnished is believed to be accurate and reliable. However, STMicroelectronics assumes no responsibility for the consequences of use of such information nor for any infringement of patents or other rights of third parties which may result from its use. No license is granted by implication or otherwise under any patent or patent rights of STMicroelectronics. Specifications mentioned in this publication are subject to change without notice. This publication supersedes and replaces all information previously supplied. STMicroelectronics products are not authorized for use as critical components in life support devices or systems without express written approval of STMicroelectronics. The ST logo is a trademark of STMicroelectronics

© 2003 STMicroelectronics - Printed in ITALY- All Rights Reserved.

STMicroelectronics GROUP OF COMPANIES

Australia - Brazil - Canada - China - Finland - France - Germany - Hong Kong - India - Israel - Italy - Japan - Malaysia -  
Malta - Morocco - Singapore - Spain - Sweden - Switzerland - United Kingdom - U.S.A.

<http://www.st.com>



This datasheet has been download from:

[www.datasheetcatalog.com](http://www.datasheetcatalog.com)

Datasheets for electronics components.